

# Limit Switches

Catalog  
March  
**07**

File 9007 / XC



## CONTENTS

Selection Guide . . . . .	2
Applications by Market Segment . . . . .	10
Osiswitch® XC Product Overview . . . . .	12
Osiswitch Snap Action Limit Switches . . . . .	22
Osiswitch Miniature Limit Switches . . . . .	30
Osiswitch Compact Limit Switches . . . . .	52
Osiswitch Classic Limit Switches . . . . .	80
Class 9007 Industrial Snap Switches . . . . .	148
Class 9007 Miniature Limit Switches . . . . .	151
Class 9007AW Heavy Duty Industrial Limit Switches . . . . .	157
Class 9007C Heavy Duty Industrial Limit Switches . . . . .	158
Class 9007T and FT Severe Duty Mill and Foundry Limit Switches . . . . .	210
R.B.Denison® Lox-Switch™ L Severe Duty Mill and Foundry Switches . . . . .	222

# Limit Switches

## Selection Guide

### Osiswitch® Universal

Design	Miniature		Compact		
					
Catalog number	XCMD		XCKD	XCKP	XCKT
Enclosure	Metal			Plastic, double insulated	
Features	Mounting by the body or by the head				
Modularity	Head, body and connection modularity			Head and body modularity	
GENELEC conformity	—		EN 50047		EN 50047 compatible
Body dimensions (w x h x d), mm (in.)	30 x 50 x 16 (1.18 x 1.97 x 0.63)		31 x 65 x 30 (1.22 x 2.56 x 1.18)		58 x 51 x 30 (2.28 x 2.01 x 1.18)
Head	Linear movement (plunger) Rotary movement (lever) Rotary movement, multi-directional Same heads for ranges XCMD, XCKD, XCKP and XCKT				
Contact blocks	2 snap action contacts with positive opening operation	N/C + N/O; N/C + N/C			N/C + N/O
	3 snap action contacts with positive opening operation	N/C + N/C + N/O	N/C + N/C + N/O; N/C + N/O + N/O		—
	4 snap action contacts with positive opening operation	N/C + N/C + N/O + N/O			—
	2 slow break contacts with positive opening operation	N/C + N/O break before make	N/C + N/O break before make; N/O + N/C make before break; N/C + N/C simultaneous		
	2 slow break contacts	—	N/O + N/O simultaneous		
	3 slow break contacts with positive opening operation	N/C + N/C + N/O break before make	N/C + N/C + N/O break before make; N/C + N/O + N/O break before make		—
Insulation voltage (Ui) / thermal current (Ithe)	Pre-cabled 2 contacts: 400 V/6 A 3 contacts: 400 V/4 A 4 contacts: 400 V/3 A		Screw terminal 2 contacts: 500 V/10 A 3 contacts: 400 V/6 A		Screw terminal 2 contacts: 500 V/10 A
Connector	Integral M12, 4-pin: 250 V/3 A Integral M12, 5-pin: 60 V/4 A Remote 7/8" 16UN: 250 V/6 A		Integral M12, 5-pin: 60 V/4 A	Integral M12, 4-pin: 250 V/3 A	—
Degree of protection	NEMA Types 1, 2, 4X, 6, 12 IP 66, IP 67, IP 68, IK 06		NEMA Types 1, 2, 4, 6, 12, 13 IP 66, IP 67, IK 06	NEMA Types 1, 2, 4, 6, 6P, 12, 13 IP 66, IP 67, IK 04	NEMA Types 1, 2, 4, 6, 12, 13 IP 66, IP 67, IK 04
Connection	Screw terminals	—			2 entries for ISO M16 or PG 11 conduit thread or 1/2" NPT (using adapter)
	Pre-cabled	Integral: No Remote: Yes	—		
	Connector	Integral or remote M12 or remote 7/8" 16UN	Integral M12		—
Page	42		54 and 58	60 and 64	66

# Limit Switches

## Selection Guide

### Osiswitch® Optimum and Application

Design	Miniature Optimum	Compact Application: with manual reset		
--------	-------------------	--	--	--



Catalog number	XCMN	XCDR	XCPR	XCTR
<b>Enclosure</b>	Plastic, double insulated	Metal	Plastic, double insulated	
<b>Features</b>	Mounting by the body or by the head	Mounting by the body		
<b>Modularity</b>	—			
<b>CENELEC conformity</b>	—			
<b>Body dimensions (w x h x d), mm (in.)</b>	30 x 50 x 16 (1.18 x 1.97 x 0.63)	31 x 65 x 30 (1.22 x 2.56 x 1.18)		58 x 51 x 30 (2.28 x 2.01 x 1.18)
<b>Head</b>	Linear movement (plunger) Rotary movement (lever) Rotary movement, multi-directional	Linear movement (plunger) Rotary movement (lever) Same heads for ranges XCDR, XCPR and XCTR		
<b>Contact blocks</b>	2 snap action contacts with positive opening operation	N/C + N/O		
	3 snap action contacts with positive opening operation	—		
	4 snap action contacts with positive opening operation	—		
	2 slow break contacts with positive opening operation	—	N/C + N/O break before make	
	2 slow break contacts	—		
<b>Insulation voltage (Ui) / thermal current (Ithe)</b>	Screw terminal 2 contacts: 400 V/6 A	Screw terminal 2 contacts: 500 V/10 A		
	<b>Connector</b>	—		
<b>Degree of protection</b>	NEMA Types 1, 2, 13 IP 65, IK 04	IP 66, IP 67, IK 04		
<b>Connection</b>	<b>Screw terminals</b>	—	1 entry for ISO M20 or PG 13 conduit thread or 1/2" NPT	2 entries for ISO M16 or PG 11 conduit thread or 1/2" NPT (using adapter)
	<b>Pre-cabled</b>	Yes	—	
	<b>Connector</b>	—		
<b>Page</b>	50	74	76	78

# Limit Switches

## Selection Guide

### Osiswitch® Classic

Design	Classic		
--------	---------	--	--



Catalog number	XCKM	XCKL	XCKJ
Enclosure	Metal		
Features	3 conduit entries		Fixed or plug-in body, -40 °C (-40 °F) or +120 °C (+248 °F) versions
Modularity	Head + Body + Operator		
CENELEC or DIN conformity	—		EN 50041
Body dimensions (w x h x d), mm (in.)	63 x 64 x 30 (2.48 x 2.52 x 1.18)	52 x 72 x 30 (2.05 x 2.83 x 1.18)	40 x 77 x 44 (1.57 x 3.03 x 1.73) 42.5 x 84 x 36 (1.67 x 3.31 x 1.42)
Head	Linear movement (plunger) Rotary movement (lever) Rotary movement, multi-directional		
Contact blocks	2 snap action contacts with positive opening operation	N/C + N/O; N/C + N/C	N/C + N/O
	3 snap action contacts with positive opening operation	N/C + N/O; N/C + N/C	
	C/O snap action contacts	N/C + N/C + N/O; N/C + N/O + N/O	
	C/O slow break contacts	—	
	2 slow break contacts with positive opening operation	2 C/O	
	2 slow break contacts	—	
Insulation voltage (Ui) / thermal current (Ithe)	2 slow break contacts with positive opening operation	N/C + N/O break before make N/O + N/C make before break N/C + N/C simultaneous	
	2 slow break contacts	N/O + N/O simultaneous	
	3 slow break contacts with positive opening operation	N/C + N/C + N/O break before make; N/C + N/O + N/O break before make	
Degree of protection	Screw terminal 2 contacts: 500 V/10 A 3 contacts: 400 V/6 A		Connector Integral M12, 5-pin: 60 V/4 A Integral 7/8" 16UN: 250 V/6 A
	NEMA Types 1, 2, 4, 6, 6P, 12, 13 IP 66, IK 06		NEMA Types 1, 2, 4, 12 IP 66 IK 07
Connection	Screw terminals (cable entry)	3 entries for ISO M20 or PG 11 conduit thread or 1/2" NPT	1 entry incorporating cable entry or tapped 1/2" NPT
	Connector	—	1 entry for ISO M20 or PG 13 conduit thread or 1/2" NPT
Page	80	80	96



# Limit Switches

## Selection Guide

### Osiswitch® Classic, Application, and Miniature Snap Switches

Design	Classic	Application: for installations requiring electrical redundancy	Application: for lifting and materials handling equipment or very severe applications	Sub-miniature, miniature: applications requiring high precision and a low operating force
--------	---------	--	---	---



Catalog number		XCKS	XCKML	XCR, XC1AC	XEP, XCO
Enclosure		Plastic, double insulated	Metal	Metal or polyester	Plastic
Features		—	2 sets of contacts	—	Depending on type
Modularity		Head + Body + Operator		Fixed composition	Depending on type, fixed composition or contact and operator
CENELEC or DIN conformity		EN 50041	—	—	—
Body dimensions (w x h x d), mm (in.)		40 x 72.5 x 36 (1.57 x 2.85 x 1.42)	72 x 81 x 36 (2.83 x 3.19 x 1.42)	Depending on type	DIN 41635, depending on type
Head		Linear movement (plunger) Rotary movement (lever) Rotary movement, multi-directional	Linear movement (plunger) Rotary movement (lever)	—	Linear movement (plunger)
Contact blocks	2 snap action contacts with positive opening operation	N/C + N/O; N/C + N/C	2 x N/C + N/O contact blocks	Depending on type	—
	3 snap action contacts with positive opening operation	N/C + N/C + N/O; N/C + N/O + N/O	—	—	—
	C/O snap action contacts	2 C/O	—	Depending on type	1 single-pole contact
	C/O slow break contacts	—	—	Depending on type	—
	2 slow break contacts with positive opening operation	N/C + N/O break before make N/O + N/C make before break N/C + N/C simultaneous	2 x N/C + N/O break before make contact blocks	Depending on type	—
	2 slow break contacts	N/O + N/O simultaneous	—	—	—
Insulation voltage (Ui) / thermal current (Ithe)		Screw terminal 2 contacts: 500 V/10 A 3 contacts: 400 V/6 A	Screw terminal 2 contacts: 500 V/10 A	—	Depending on type
Degree of protection		IP 65 IK 03	NEMA Types: 1, 2, 4, 6, 6P, 12, 13 IP 66 IK 06	Depending on type: IP 66, IK 05; IP 65, IK 05; or IP 54, IK 05	Depending on type
Connection	Screw terminals (cable entry)	1 entry for ISO M20 or PG 13 conduit thread	3 entries for ISO M20 or PG 13 conduit thread; or PG 13 to 1/2" NPT with adapter	Depending on type: 1 or 3 entries for ISO M20 or PG 13 conduit thread	Depending on type: by tags or pre-wired
	Connector	—	—	—	—
Page		124	80	134 and 142	24

# Limit Switches

## Selection Guide

### Class 9007 Industrial Snap Switches and Miniature Industrial Switches

Design	Industrial Snap Switch	Miniature Switch	Miniature Enclosed Reed	Heavy Duty Industrial, Precision Oiltight
--------	------------------------	------------------	-------------------------	---



Catalog Number Prefix	9007A 9007C	9007MS 9007ML	9007XA	9007AW
<b>Description</b>	Industrial snap switches with or without operators	Miniature enclosed switches, potted and pre-wired with cable. Unique rotary head. 9007 ML has double break contacts.	Miniature enclosed switches, potted and pre-wired with cable. Reed contacts for superior low-energy switching.	Precision oil tight enclosed switches with unique features, micrometer adjustable and low temperature operation.
<b>Enclosure Material</b>	Plastic	Metal bodies, metal head	Metal bodies, metal head	Metal bodies, metal heads
<b>Enclosure Rating</b>	None	NEMA: Types 1, 2, 4, 6, 6P, 12, 13 IEC: IP67	NEMA: Types 1, 2, 4, 6, 6P, 12, 13	NEMA: Types 1, 2, 4, 6, 6P, 12, 13
<b>Approximate Body Dimensions, mm (in.)</b>	29.0 x 63.5 x 21.0 (1.14 x 2.5 x 0.83)	40.1 x 44.4 x 15.8 (1.58 x 1.75 x 0.62)	40.1 x 44.2 x 16.0 (1.58 x 1.74 x 0.63)	36.6 x 98.5 x 63.5 (1.44 x 3.88 x 2.5)
<b>Heads</b>	Linear	Linear or Rotary	Linear or Rotary	Linear or Rotary
<b>Contact Blocks</b>				
<b>N.C. + N.O. snap action</b>	X	X	N.O. or N.C.	X
<b>N.C. + N.O. break before make, slow break</b>				
<b>N.O. + N.C. make before break, slow break</b>				
<b>N.C. + N.C. simultaneous, slow break</b>				
<b>N.O. + N.O. simultaneous, slow break</b>				
<b>C/O snap action</b>				
<b>C/O slow break</b>				
<b>N.C. + N.C. 2-step, slow break</b>				
<b>N.O. + N.O. 2-step, slow break</b>				
<b>N.C. + N.C. snap action</b>				
<b>N.O. + N.C. slow make, slow break</b>				
<b>Cabling</b>		Pre-wired cable, M12 Connector option available.	Pre-wired cable.	
<b>Temperature Range</b>	-65 to +221 °F (-54 to +105 °C)	-40 to +221 °F (-40 to +105 °C)	-20 to +140 °F (-29 to +60 °C)	0 to +185 °F (-17.8 to 85 °C) Lever operated: -65 to +185 °F (-54 to 85 °C)
<b>Additional Features</b>	A variety of operators are available, page 148	Bottom or side cable entry. Full range of operating heads, page 152.	Bottom cable entry. Three common operating heads, page 156.	Most common operating heads. Micrometer adjustable push rod plunger. Uses 9007C levers, page 186.

# Limit Switches

## Selection Guide

### Class 9007 Type C Heavy Duty Industrial

Applications	Material handling—mechanical conveying, automotive, machine tool, packaging			Hazardous application locations: gases (explosion), dust environment.
Design	Standard body type 9007C****	Standard body reed contacts	Compact body type 9007C52**	Hazardous location body type 9007CR****



Catalog number	9007C54*** 9007C62*** 9007C68*** 9007C66***	9007C84*** 9007C86***	9007C52**	9007CR53** 9007CR61** 9007CR65** 9007CR67**			
Enclosure	Metal, diecast, zinc alloy						
Features	Plug-in body			Non-plug-in body			
Factory modifications (Forms)	See pages 172 to 176						
Modularity	Head + body + lever						
Conforming to standards	NEMA 250, EN 60947-1, EN 60947-5-1, IEC 60947, UL 508, C22-2-14-95, CE conformity documentation			NEMA 250, EN 60947-1, EN 60947-5-1, IEC 60947, UL 508, C22-2-14-95, CE conformity documentation			
Product certifications	UL, CSA, CE						
Body dimensions (w x h x d), mm (in.) with rotary head	39 x 102 x 45 (1.54 x 4.02 x 1.77)		39 x 80 x 45 (1.54 x 3.15 x 1.77)	69 x 156 x 53 (2.72 x 6.14 x 2.10)			
Head	Linear movement (plunger) Rotary movement (lever) Multi-directional movement (wobble stick, cat whisker)						
Contact blocks	Snap action contacts	9007C54***	1 N.O. + 1 N.C.	Reed contacts 1 N.O. or 1 N.C.	1 N.O. + 1 N.C.	9007CR53**	1 N.O. + 1 N.C.
		9007C62***	2 N.O. + 2 N.C.			9007CR61**	2 N.O. + 2 N.C.
9007C68***		2 N.O. + 2 N.C. neutral position	9007CR65**			2 N.O. + 2 N.C. neutral position	
9007C66***		2 N.O. + 2 N.C. two stage	9007CR67**			2 N.O. + 2 N.C. two stage	
	Direct opening (positive opening)	9007C**** Y1561  Plunger and lever heads only Single pole only		9007C**** Y1561 Single pole only	9007CR**** Y1561 Single pole only		
Rated insulation voltage	600 V		—				
Insulation voltage (Ui)—top half of body	600 V Except: 9007CO62, 9007CO66, 9007CO68 (Ui = 250 V) and 9007C84, 9007C86 (Ui = 125 V)		600 V	600 V Except: 9007CR63, 9007CR65, 9007CR67 (Ui = 250 V)			
Thermal current (Ithe)—top half of body	10 A Excepted: 9007CO84, 9007CO86 (2.5 A)		10 A	10 A			
Degree of protection	IP 67 conforming to IEC 60529, NEMA Types 2, 4, 6, 6P, 12, 13		IP 67 conforming to IEC 60529 NEMA Types 2, 4, 6, 6P, 12, 13,	NEMA Types 2, 4, 6P, 7, 9, 13			
Connection (1)	Cable entry or connector Depending on model: 1/2"-14 NPT, M20 x 1.5 ISO cable entry, 5-pin mini connector.		Cable entry or connector Depending on model: 1/2"-14 NPT, M20 X 1.5 ISO cable entry, 5 pin mini connector.	Cable entry or connector Depending on model: 1/2"-14 NPT, M20 X 1.5 ISO cable entry, 3/4 14 NPT available.			
Page	160		168	194			

1. A wide range of connectors are available. Contact your local field office.

# Limit Switches

## Selection Guide

### Severe Duty Mill and Foundry Switches

Applications	Mill	Mill	Mill	Mill
Design	9007T Convertible sequence	L100 Fixed sequence	L14 Single Cable Pulls Fixed sequence	L525 Belt Conveyor Fixed sequence



Limit Switches

Catalog number	9007T***	L100***	L14	L525
Enclosure	Metal	Metal	Metal	Metal
Features	Extra heavy duty contact ratings	Extra heavy duty contact ratings	Extra heavy duty contact ratings	Extra heavy duty contact ratings
Factory modifications (Forms)	Page 217	Page 233	Page 233	Page 233
Conforming to standards Product	NEMA A600 UL508	NEMA A600 UL508	NEMA A600 UL508	NEMA A600 UL508
Product certifications	UL Listed, CSA Certified	UL Listed, CSA Certified	UL Listed, CSA Certified	UL Listed, CSA Certified
Body dimensions (w x h x d), mm (in.) surface mounting	58.7 x 114.3 x 64.5 (2.31 x 4.5 x 2.54)	58.7 x 126 x 53.3 (2.31 x 4.95 x 2.10)	58.7 x 126 x 53.3 (2.31 x 4.95 x 2.10)	58.7 x 126 x 53.3 (2.31 x 4.95 x 2.10)
Head	Rotary movement (lever)	Rotary movement (lever)	Rotary movement (lever) (3)	Rotary movement (lever) (3)
Contact blocks	1 N.C. + 1 N.O.	1 N.C. + 1 N.O.	1 N.C. + 1 N.O.	1 N.C. + 1 N.O.
	Convertible	Fixed	Fixed	Fixed
Rated insulation voltage	600 V	600 V	600 V	600 V
Thermal current (Ithe)	20 A ac/dc	20 A ac, 5 A dc	20 A ac, 5 A dc	20 A ac, 5 A dc
Degree of protection	NEMA Types 1, 2, 4, 12, 13 IP65, 66, 67	NEMA Types 1, 4, 13 IP65, 66	NEMA Types 1, 4, 13 IP65, 66	NEMA Types 1, 4, 13 IP65, 66
Connection (2)	Cable entry or connector 1/2" NPT (metric available)	Cable entry or connector 1/2" NPT (metric available)	Cable entry or connector 1/2" NPT (metric available)	Cable entry or connector 1/2" NPT (metric available)
Presentation, Applications and Characteristics	Page 212	Page 224	Page 228	Page 229
Interpretation of Catalog Numbers	Page 235	Page 235	Page 235	Page 235

1. For other contact options see page 212.
2. A wide range of connectors are available. Contact your local field office.
3. Lever arms are optional and must be ordered separately.

# Limit Switches

## Selection Guide

### Severe Duty Mill and Foundry Switches

Applications	Foundry	Foundry	Mill and Foundry
Design	9007FT Convertible sequence	L300 Fixed sequence	L2153 Dual Pull Stop Fixed sequence



Catalog number	9007FT**	L300**	L2153
Enclosure	Metal	Metal	Metal
Features	Designed specifically for rough foundry applications	Designed specifically for rough foundry applications	Extra heavy duty contact ratings
Factory modifications (Forms)	Page 217	Page 233	Page 233
Conforming to standards	NEMA A600 UL508	NEMA A600 UL508	NEMA A600 UL508
Product certifications	UL Listed, CSA Certified	UL Listed, CSA Certified	UL Listed, CSA Certified
Body dimensions (w x h x d), mm (in.) surface mounting	58.7 x 114.3 x 86.6 (2.31 x 4.5 x 3.41)	58.7 x 126 x 53.3 (2.31 x 4.95 x 2.10)	58.7 x 126 x 53.3 (2.31 x 4.95 x 2.10)
Head	Rotary movement (lever)	Rotary movement (lever)	Rotary movement (lever) (2)
Contact blocks	1 N.C. + 1 N.O.	1 N.C. + 1 N.O.	1 N.C. + 1 N.O.
Snap action contacts ♦ Sequences	Convertible	Fixed	Fixed
Rated insulation voltage	600 V	600 V	600 V
Thermal current (Ithe)	20 A ac/dc	20 A ac, 5 A dc	20 A ac, 5 A dc
Degree of protection	NEMA Types 1, 2, 4, 12, 13 IP65, 66, 67	NEMA Types 1, 4, 13 IP65, 66	NEMA Types 1, 4, 13 IP65, 66
Connection (1)	Cable entry or connector 1/2" NPT (metric available)	Cable entry or connector 1/2" NPT (metric available)	Cable entry or connector 1/2" NPT (metric available)
Presentation, Applications and Characteristics	Page 214	Page 226	Page 228
Interpretation of Catalog Numbers	Page 235	Page 235	Page 235

1. A wide range of connectors are available. Contact your local field office.
2. Lever arms are optional and must be ordered separately.

# Limit Switches Selection Guide Applications by Market Segment

## Crane and Hoist

- Overhead Cranes
- Transport Systems

## Mill and Foundry

- Iron and Steel
- Cement and Glass

## Process Machinery

- Machine Tools
- Plastic, Rubber, Molding
- Printing
- Textile
- Pulp, Paper, Wood

## Material Handling

- Conveyance
- Carousels
- Automatic Storage/Retrieval

## Packaging Machinery

- Packaging Machines
- Shrink Wrap

## Food and Beverage Machinery

- Bottling
- Canning

## Simple Machines

- Transportation Wash
- Light Handling
- Assembly Stations
- General Purpose

## Electric Lifts

- Lifting Platforms
- Elevators
- Escalators

*NOTE: Special electrical options available for:*

- Low current switching for programmable controllers
- Hazardous locations



XCKP  
XCKT  
XCKD

XCKM  
XCKL  
XCKML

XCMD  
9007MS/ML  
9007XA

XCKS

**Limit Switches**  
**Selection Guide**  
**Applications by Market Segment**



**9007AW**

**XCKJ  
9007C**

**L100/L300  
9007T/FT**

**XCR  
9007CLS**

Limit Switches

# Limit Switches

## Selection Guide

### Osiswitch® XC Product Overview

#### Introduction

#### Electromechanical detection

Limit switches are used in all automated installations and also in a wide variety of applications, due to the numerous advantages inherent to their technology.

They transmit data to the logic processing system regarding:

- presence/absence
- passing
- positioning
- end of travel

#### Simplicity of installation, advantages

From an electrical viewpoint

- galvanic separation of circuits,
- models suitable for low power switching, combined with good electrical durability,
- very good short-circuit withstand in coordination with appropriate fuses,
- total immunity to electromagnetic interference,
- high rated operational voltage.

From a mechanical viewpoint

- N/C contacts with positive opening operation,
- high resistance to the different ambient conditions encountered in industry (standard tests and specific tests under laboratory conditions),
- high repeat accuracy, up to 0.01 mm on the tripping points.

#### Detection movements

- Linear movement (plunger)
- Rotary movement (lever)
- Multi-directional movement

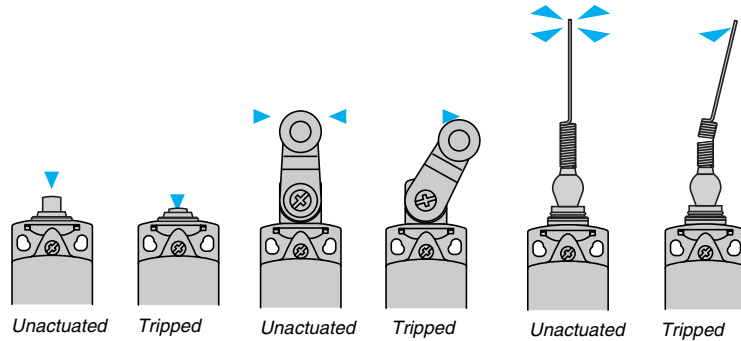

#### Terminology

#### Rated value of a quantity

- This replaces the term "nominal value".
- It is the fixed value for a specific function.

#### Utilization categories

- AC-15 replaces AC-11: control of an electromagnet on a.c., test 10 I<sub>e</sub>/I<sub>e</sub>.
- AC-12: control of a resistive load on a.c. or static load isolated by opto-coupler.
- DC-13 replaces DC-11: control of an electromagnet on d.c., test I<sub>e</sub>/I<sub>e</sub>.
- I<sub>th</sub> is no longer a rated value but a conventional current used for heating tests.

#### Switching capacity

**Example:** for category A300 the corresponding operational current, I<sub>e</sub> maximum, is 6 A-120 V or 3 A-240 V, the equivalent I<sub>th</sub> being 10 A.

#### Positive opening travel

- Minimum travel from the initial movement of contact actuator to the position required to accomplish positive opening operation.

#### Positive opening force

- The force required on the contact actuator to accomplish positive opening operation.

#### Positive opening operation

- A limit switch complies with this specification when all the closed contact elements of the switch can be changed, with certainty, to the open position (no flexible link between the moving contacts and the operator of the switch, to which an actuating force is applied).
- All limit switches incorporating either a slow break contact block or a snap action N/C + N/O (form Zb), N/C + N/O + N/O, N/C + N/C + N/O, N/C + N/C + N/O + N/O contact block are positive opening operation, in complete conformity with standard IEC 60947-5-1 Appendix K.



# Limit Switches

## Selection Guide

### Osiswitch® XC Product Overview

#### Contact blocks

#### Snap action contacts

- Snap action contacts are characterized by different tripping and reset points (differential travel).
- The displacement speed of the moving contacts is not related to the speed of the operator.
- This feature ensures satisfactory electrical performance in applications involving low speed actuators.

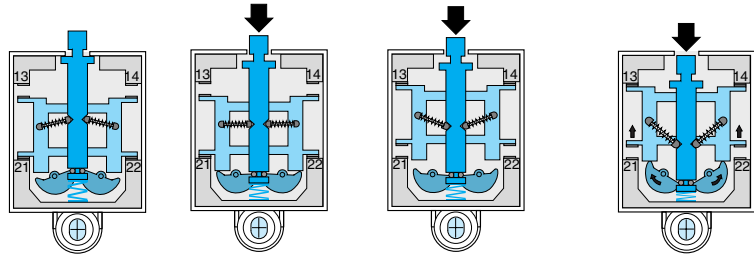

Unactuated state    Approach travel    Contact change of state    Positive opening

#### Slow break contacts

- Slow break contacts are characterized by identical tripping and resetting points.
- The displacement speed of the moving contacts is equal, or proportional, to the speed of the operator—which must not be less than 0.1 m/s, or 6 m/minute (0.33 ft/s, or 19.68 ft/minute).
- The opening distance also depends on the distance traveled by the operator.

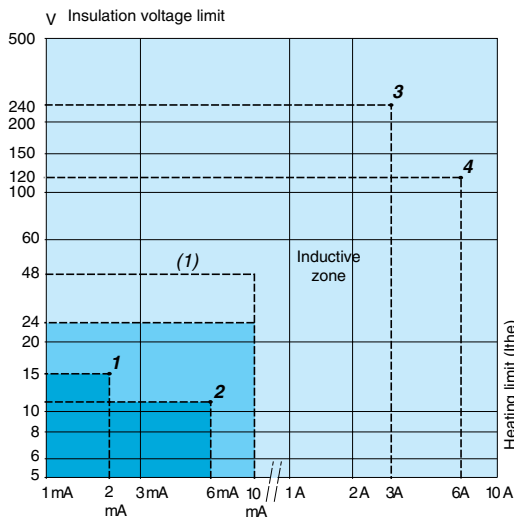
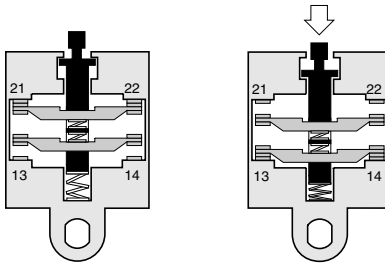

#### Electrical durability for normal loads

- Normally, for inductive loads, the current value is less than 0.1 A (sealed), i.e. values of 3 to 40 VA sealed and 30 to 1000 VA inrush, depending on the voltage.

For this type of application the electrical durability exceeds 10 million operating cycles.

**Application example:** XCKJ161 + LC1D12\*\*\* (7 VA sealed, 70 VA inrush).

Electrical durability = 10 million operating cycles.

#### Switching capacity

1. Normal industrial PLC input type 1
2. Normal industrial PLC input type 2
3. Switching capacity conforming to IEC 60947-5-5, utilization category AC-15, DC-13
 

A300	240 V	3 A	B300	240 V	1.5 A
Q300	250 V	0.27 A	R300	250 V	0.13 A
4. Switching capacity conforming to IEC 60947-5-1, utilization category AC-15, DC-13
 

A300	120 V	6 A	B300	120 V	3 A
Q300	125 V	0.55 A	R300	125 V	0.27 A

#### Electrical durability for small loads

- The use of limit switches with programmable controllers is becoming more common.
- With small loads, limit switches offer the following levels of reliability:
- failure rate of less than 1 for 100 million operating cycles using snap action contacts (contacts XE2SP).
- failure rate of less than 1 for 20 million operating cycles using slow break contacts (contacts XE•NP and XE3SP).
- failure rate of less than 1 for 5 million operating cycles using contacts XCMD.

Range of use	
<b>Standard contacts</b>	XE2SP2151, P3151
Continuous service (frequent switching)	XE2NP*** Contacts of XCMD, XE3•P***
<b>Gold flashed contacts</b> on resistive load	Occasional service Infrequent switching, ≤ 1 operating cycle/day and/or corrosive atmosphere

1. Usable up to 48 V/10 mA.

# Limit Switches

## Selection Guide

### Osiswitch® XC Product Overview

#### Principle

#### Innovation through modularity

- The Miniature design XCMD and Compact design XCKD, XCKP and XCKT product range family benefits from the **Osisconcept™** principle: **Offering simplicity through innovation.**
- A first in worldwide detection for improving productivity. A complete offer for resolving the most commonly encountered detection problems:
  - product selection simplified,
  - product availability simplified,
  - installation and setup simplified,
  - maintenance simplified.

#### Heads

- A single metal operating head type for the Miniature design XCMD and Compact design XCKD, XCKP and XCKT ranges.

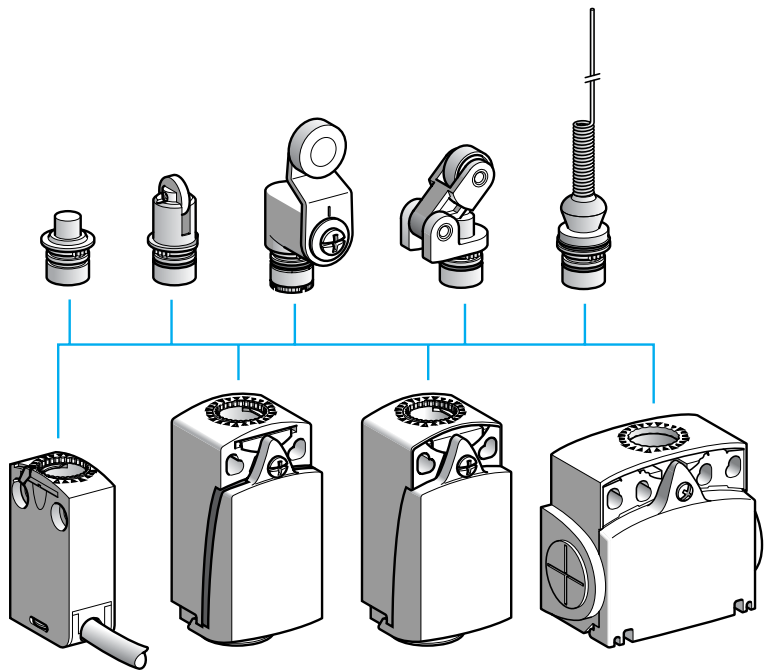

- Interchanging of heads achieved by simple operation of forked metal latch.
- Adjustable in 3 planes:

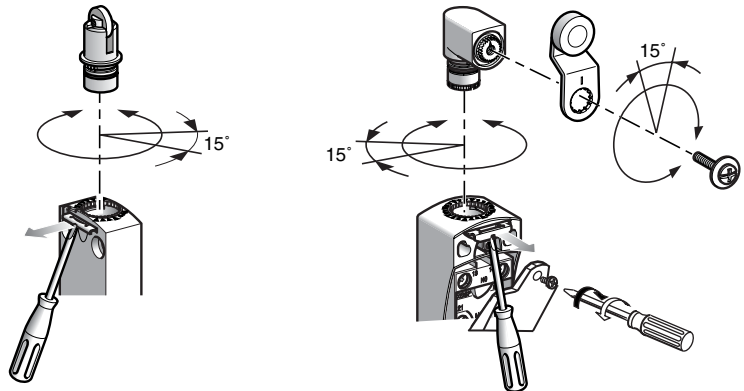

*All the heads can be adjusted in 15° steps throughout 360°, in relation to the body.*

*All the levers can be adjusted in 15° steps throughout 360°, in relation to the horizontal axis of the head.*

# Limit Switches

## Selection Guide

### Osiswitch® XC Product Overview

#### Principle (continued)

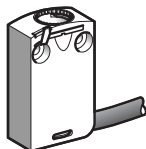
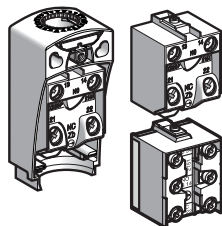
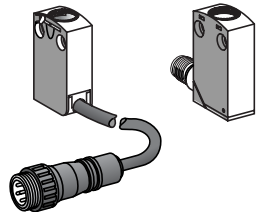
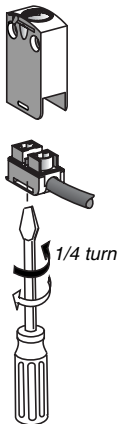
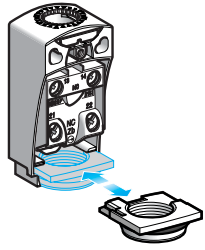

#### Cable entries

The cable entries for Compact design XCKD and XCKP switches enable:

- simple cabling due to unrestricted access to contacts
- simple adaptation to the various worldwide markets

6 models are available:

- ISO M16 x 1.5
- PG 11
- ISO M20 x 1.5
- PG 13
- 1/2" NPT
- PF 1/2 (G 1/2)

Each model is available in metal or plastic, suited for compact design XCKD or XCKP, respectively. A connector version is also available.

#### Connection components

- The miniature XCMD range allows interchangeability of these pre-cabled connection components:
  - 1/4 turn is all that is required to remove the connection component on XCMD bodies with 2 and 3 contacts,
  - 6 alternative cable lengths are available.
- The miniature XCMD range also includes an integral or remote connector solution.

#### Contact block or body with contacts

- 2 and 3 snap action and slow break contact blocks, with positive opening operation, are interchangeable between the Compact design XCKD and XCKP and Classic XCKJ, XCKS, XCKM and XCKL ranges.
- For the Miniature design XCMD range, the contacts are an integral part of the body:
  - 2 and 3 snap action and slow break contacts, with positive opening operation, and interchangeable connection component,
  - 4 snap action contacts, with positive opening operation, with monolithic body and connection components.

# Limit Switches

## Selection Guide

### Osiswitch® XC Product Overview

#### Contact blocks (continued)

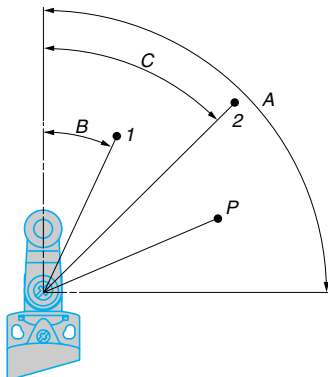
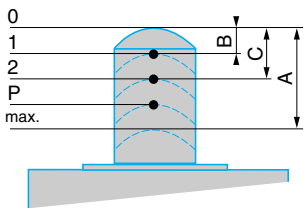
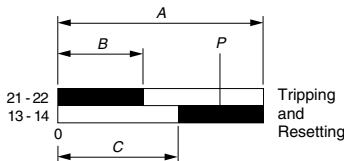
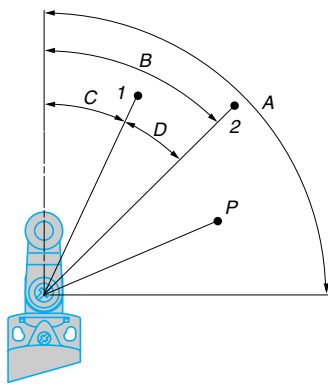
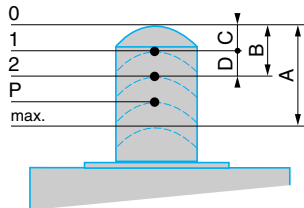
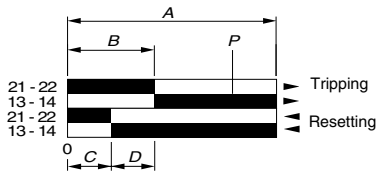

#### Functional diagrams of snap action contacts

- Example: N/C + N/O

A—Maximum travel of the operator in mm or degrees.  
B—Tripping travel of contact.  
C—Resetting travel of contact.  
D—Differential travel = B–C.  
P—Point from which positive opening is assured.

- Linear movement (plunger)

1—Resetting point of contact.  
2—Tripping point of contact.  
A—Maximum travel of the operator in mm.  
B—Tripping travel of contact.  
C—Resetting travel of contact.  
D—Differential travel = B–C.  
P—Point from which positive opening is assured.

- Rotary movement (lever)

1—Resetting point of contact.  
2—Tripping point of contact.  
A—Maximum travel of the operator in degrees.  
B—Tripping travel of contact.  
C—Resetting travel of contact.  
D—Differential travel = B–C.  
P—Point from which positive opening is assured.

#### Functional diagrams of slow break contacts

- Example: N/C + N/O break before make

A—Maximum travel of the operator in mm or degrees.  
B—Tripping and resetting travel of contact 21-22.  
C—Tripping and resetting travel of contact 13-14.  
P—Point from which positive opening is assured.

- Linear movement (plunger)

1—Tripping and resetting points of contact 21-22.  
2—Tripping and resetting points of contact 13-14.  
A—Maximum travel of the operator in mm.  
B—Tripping and resetting travel of contact 21-22.  
C—Tripping and resetting travel of contact 13-14.  
P—Positive opening point.

- Rotary movement (lever)

1—Tripping and resetting points of contact 21-22.  
2—Tripping and resetting points of contact 13-14.  
A—Maximum travel of the operator in degrees.  
B—Tripping and resetting travel of contact 21-22.  
C—Tripping and resetting travel of contact 13-14.  
P—Positive opening point.

# Limit Switches

## Selection Guide

### Osiswitch® XC Product Overview

#### Contact blocks (continued)

*XE2•P screw clamp terminal connections*

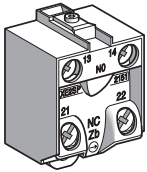

*XE3•P screw clamp terminal connections*

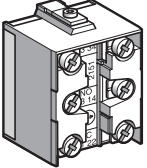

#### Mounting

#### Contact connections

- Tightening torque:
  - minimum tightening torque ensuring the nominal characteristics of the contact: 0.8 N•m (7.08 lb-in)
  - maximum tightening torque without damage to the terminals: 1.2 N•m (10.62 lb-in) for **XE2•P**, 1 N•m (8.85 lb-in) for **XE3•P**
- Connecting cable: cable preparation lengths:
  - for **XE2•P**, L = 22 mm (0.87 in.)
  - for **XE2•P3•••**, L = 45 mm (1.77 in.)
  - for **XE3•P**:
    - L = 14 mm (0.55 in.)
    - L1 = 11 mm (0.43 in.)

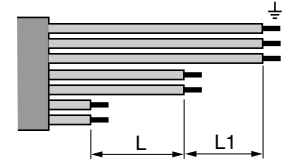
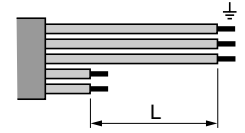

#### Sweep of connecting cable

- 1 Recommended
- 2 To be avoided

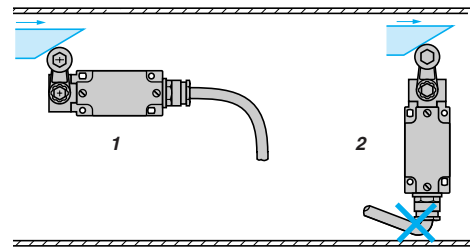

#### Position of cable entry

- 1 Recommended
- 2 To be avoided

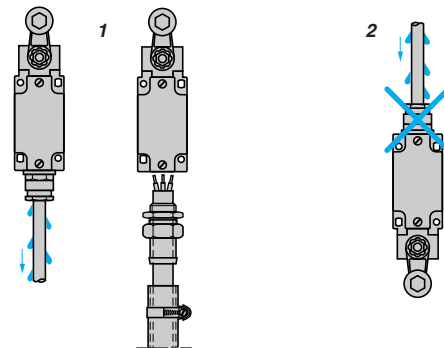

#### Type of cam

- 1 Recommended
- 2 To be avoided

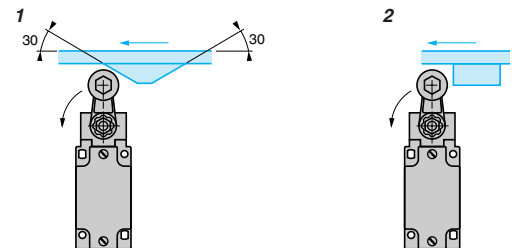

#### Mounting limit switches by the head

- 1 Recommended
- 2 Forbidden

*Types XCKD, XCKP and XCKT, XCMD and XCMN*

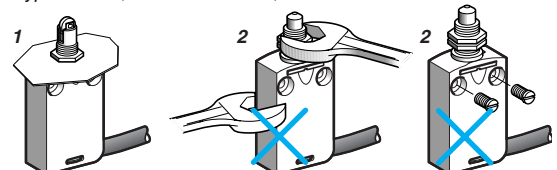

# Limit Switches

## Selection Guide

### Osiswitch® XC Product Overview

#### Setup

#### Tightening torque

- The minimum torque is that required to ensure correct operation of the switch.
- The maximum torque is the value which, if exceeded, will damage the switch.

Range	Item	Torque, N•m (lb-in)	
		Min.	Max.
Compact design XCKD, XCKP, XCKT	Cover	0.8 (7.08)	1.2 (10.62)
	Mounting screw for lever on rotary head	1 (8.85)	1.5 (13.28)
Miniature design XCMD, XCMN	—	—	—
	Mounting screw for lever on rotary head	1 (8.85)	1.5 (13.28)
Classic design XCKJ	Cover	1 (8.85)	1.5 (13.28)
	Mounting nut for lever on rotary head	1 (8.85)	1.5 (13.28)
Classic design XCKS	Cover	0.8 (7.08)	1.2 (10.62)
	Mounting nut for lever on rotary head	1 (8.85)	1.5 (13.28)
Classic design XCKM, XCKML, XCKL	Cover	0.8 (7.08)	1.2 (10.62)
	Mounting nut for lever on rotary head	1 (8.85)	1.5 (13.28)

#### Types XCKD, XCKP, XCKT, XCMD

- Adjustable in 3 planes:

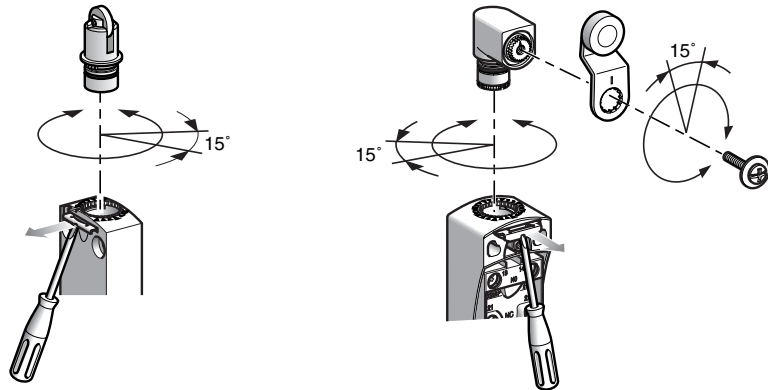

All the heads can be adjusted in 15° steps throughout 360°, in relation to the body. All the levers can be adjusted in 15° steps throughout 360°, in relation to the horizontal axis of the head.

#### Type XCKJ

- Adjustable through 360° in 5° steps, or in 45° steps by reversing the lever or its mounting.
  1. Reversed  $\alpha = 5^\circ$
  2. Forward  $\alpha = 45^\circ$

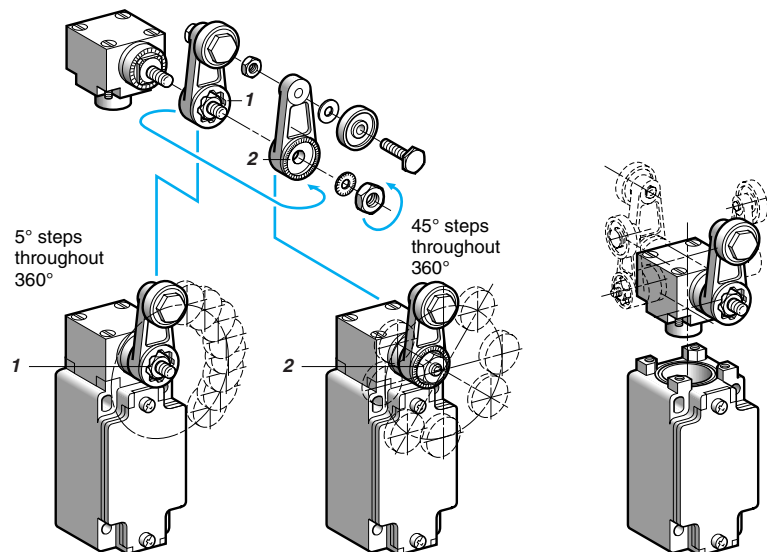

# Limit Switches

## Selection Guide

### Osiswitch® XC Product Overview

#### Setup (continued)

#### Direction of actuation programming

- XCKJ

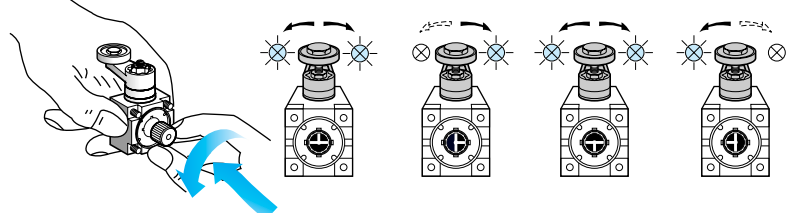

#### Head ZCKE05

- XCKS

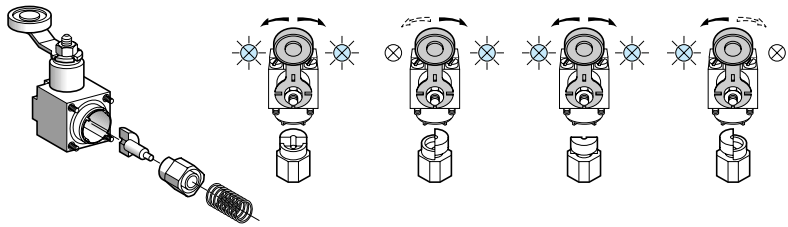

#### Head ZCKD05

- XCKD, XCKP, XCKT and XCMD

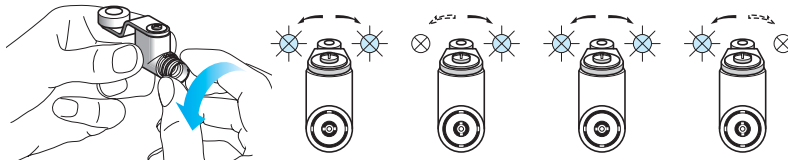

#### Head ZCE05

#### Specific cams for heads ZCKE09 and ZC2J09

- 1 0.5 mm (0.02 in.) min.
- 2 2 mm (0.08 in.) min.

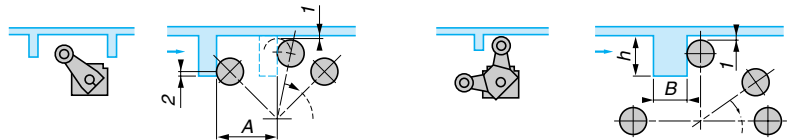

$A = \text{length of lever} + 11 \text{ mm (0.43 in.)}$

**ZCKE09:**  $h = 13\text{--}18 \text{ mm (0.51\text{--}0.71 \text{ in.})}$  and  $B = 12 \text{ mm (0.47 in.) max.}$

**ZCKJE09:**  $h = 14\text{--}24 \text{ mm (0.55\text{--}0.94 \text{ in.})}$  and  $B = 6 \text{ mm (0.24 in.) max.}$

#### ZCKG00 Head Programming

The ZCKG00 head is field convertible to CW, CCW or CW/CCW. The diagram below shows the conversion process.

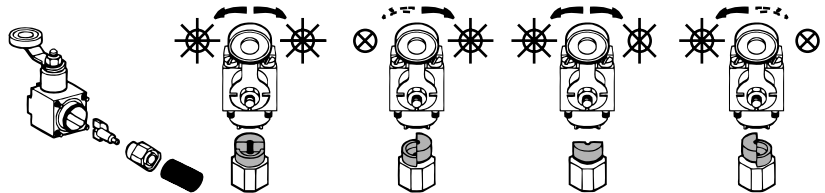

# Limit Switches

## Selection Guide





### Osiswitch® XC Product Overview

#### Compliance with standards

The majority of Telemecanique® brand products comply to national standards (such as French NF C standards, German DIN standards), European standards (such as CENELEC), or international standards (such as IEC). These standards rigidly stipulate the characteristic requirements of the designated products (for example IEC 60947 relating to low voltage switchgear and controlgear).

These products, when correctly used, enable the production of control equipment assemblies, machine control equipment or installations conforming to their own specific standards (for example IEC 60204 for the electrical equipment of industrial machines).

#### IEC 60947-5-1

<b>Insulation coordination (and dielectric strength)</b>	<ul style="list-style-type: none"> <li>The standard IEC 60664 defines 4 categories of prospective transient overvoltages. It is important for the user to select control circuit components which are able to withstand these overvoltages. To these ends, the manufacturer states the rated impulse withstand voltage (<math>U_{imp}</math>) applicable to the product.</li> </ul>	
<b>Terminal connections</b>	<ul style="list-style-type: none"> <li>The cabling capacity, mechanical robustness and durability of the terminals, as well as the ability to resist loosening, are verified by standardized tests.</li> <li>Terminal reference marking conforms to standard EN 50013.</li> </ul>	
<b>Switching capacity</b>	<ul style="list-style-type: none"> <li>With maximum electrical load. A single designation (A300 for example) enables indication of the contact block characteristics related to its utilization category.</li> </ul>	
<b>Positive opening operation (IEC 60947-5-1 Appendix K)</b>	<ul style="list-style-type: none"> <li>For contacts used in safety applications (end of travel, emergency stop device, etc.) the assurance of positive opening is required (see IEC 60204, EN 60204) after each test, the opening of the contact being verified by testing with an impulse voltage (2500 V).</li> </ul>	
<b>Electrical symbols for contacts</b>	 <ul style="list-style-type: none"> <li>Form Za, the 2 contacts are the same polarity.</li> </ul>	 <ul style="list-style-type: none"> <li>Form Zb, the 2 contacts are electrically separate.</li> </ul>
<b>Symbol for positive opening</b>	 <ul style="list-style-type: none"> <li>Simplified version</li> </ul>	 <ul style="list-style-type: none"> <li>Complete symbol</li> </ul>

#### CENELEC EN 50047

The European standards organization CENELEC, which has 14 member countries, has defined in this standard the first type of limit switch.

This standard defines 4 variants of devices (forms A, B, C, E).

Limit switches XCKP, XCKD and XCKT conform to standard EN 50047.

#### Form A, with roller lever

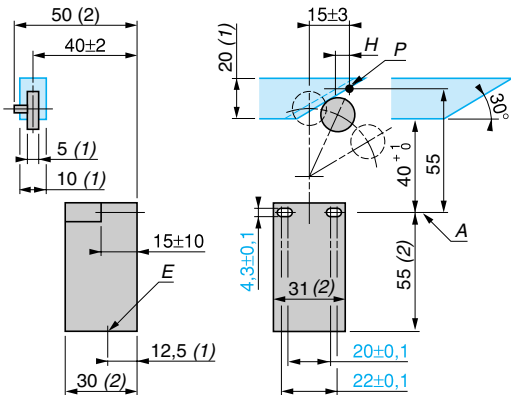

#### Form B, with end plunger (rounded)

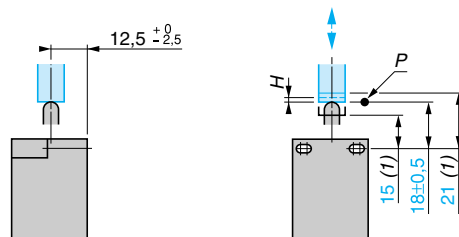

1. Minimum value
2. Maximum value

A: reference axis  
H: differential travel

P: tripping point  
E: cable entry

#### Form C, with end roller plunger

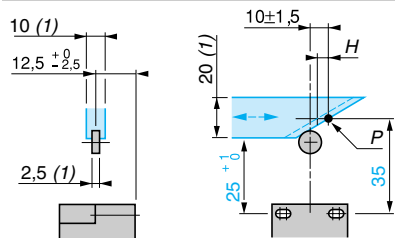

#### Form E, with roller lever for 1 direction of actuation

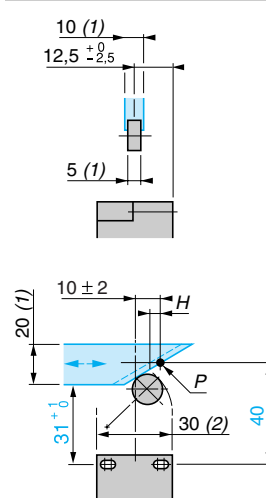



# Limit Switches

## Selection Guide

### Osiswitch® XC Product Overview

#### Compliance with standards (continued)

##### CENELEC EN 50041

The European standards organization CENELEC, which has 14 member countries, has defined in this standard the second type of limit switch.

It defines 6 variants of devices (forms A, B, C, D, F, G).

Limit switches XCKJ and XCKS conform to standard EN 50041.

#### Form A, with roller lever

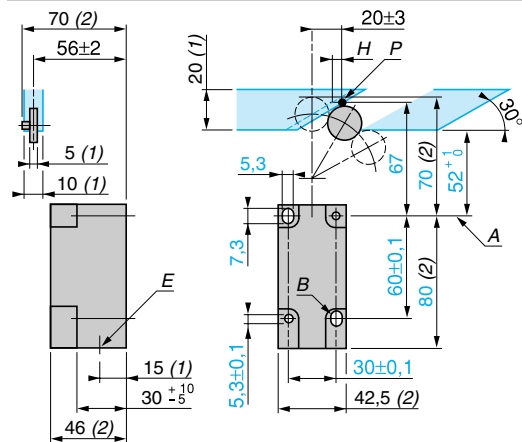

#### Form B, with end plunger (rounded)

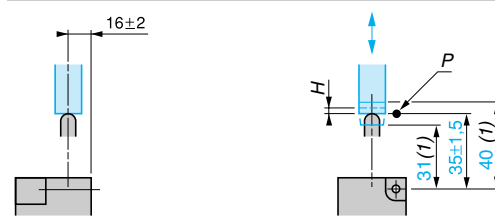

1. Minimum value
2. Maximum value

A: reference axis

B: optional elongated holes

H: differential travel

P: tripping point

E: cable entry

Za: tripping zone

Sa: tripping threshold

#### Form C, with end roller plunger

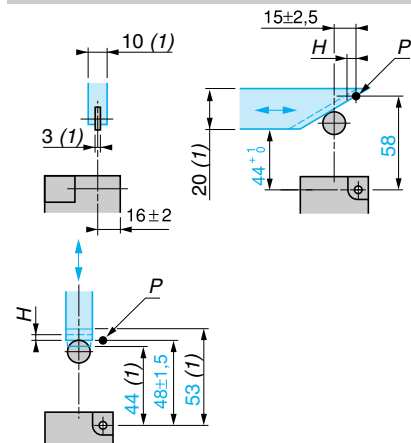

#### Form D, with rod lever

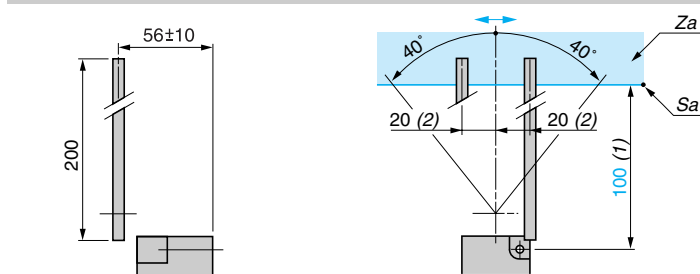

#### Form F, with side plunger (rounded)

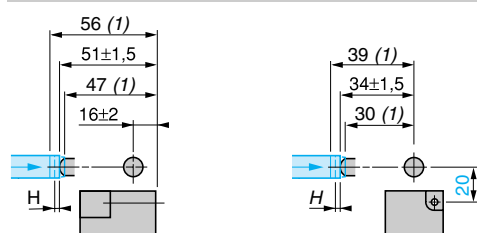

#### Form G, with side roller plunger

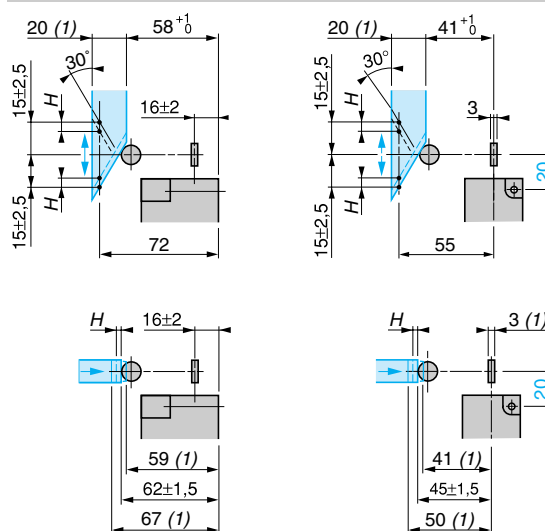

# Limit Switches

## Osiswitch® Miniature Snap Switches

### XEP and XC0

#### Introduction

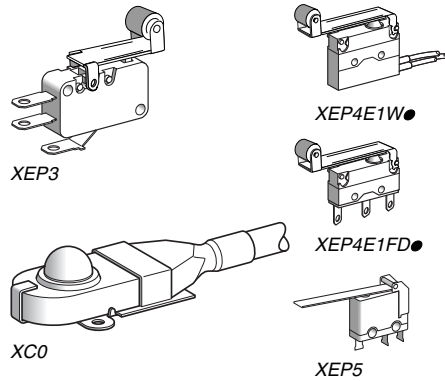

#### Terminology

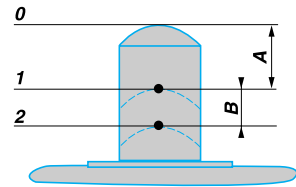

#### Mechanical characteristics

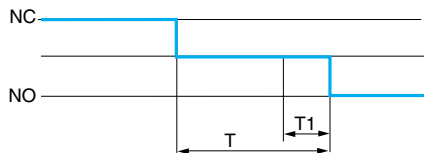

T1: bounce time  
T: changeover time

#### Mounting

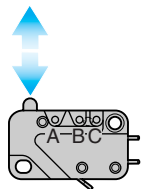

Operating speed and rate

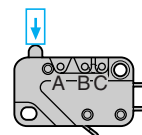

#### Electromechanical detection

Osiswitch miniature snap switches, featuring electromechanical technology, assure the following functions:

- detection of presence or absence
- detection of position.

Actuation of the operator (plunger or lever) on the miniature snap switch causes the electrical contact to change state. This information can then be processed by a PLC controlling the installation.

Osiswitch miniature snap switches can be used both for industrial applications and the building sector.

#### Features

Osiswitch miniature snap switches incorporate a C/O snap-action, single-break contact. They are characterized by:

- high electrical ratings for their very small size
- short tripping travel
- low tripping force
- high repeat accuracy on the tripping points
- long service life

#### Forces

**Maximum tripping force:** maximum force which must be applied to the operator to move it from the rest (unactuated) position to the trip position (tripping point).

**Minimum release force:** value to which the force on the operator must be reduced to allow the snap action mechanism to return to its rest (unactuated) position.

**Maximum permissible end of travel force:** maximum force that can be applied to the operator at the end of its travel without damaging the switch.

#### Position / Travel

1. Tripping point: position of the operator in relation to the switch mountings (mounting hole center line) at the instant the switch contact changes state.
- A. Differential travel: distance between the tripping point and the position at which the snap action mechanism returns to its initial state on release of the operator.
2. Overtravel limit: position of the operator when an extreme force has moved it to the effective end of its available travel.
- B. Overtravel: distance between the tripping point and the overtravel limit.

The reference point for the figures given for forces and travel is a point F, which is situated on the plunger in the case of a basic switch or at 3 mm (0.12 in.) from the end of the plain lever in the case of a lever operated switch.

#### Changeover time

This is the time taken by the moving contact when moving from one fixed contact to another until it becomes fully stable (contact bounce included).

This time is related to the inter-contact distance, the mechanical characteristics of the snap action mechanism, and the mass of the moving element. However, due to the snap action mechanisms used, the time is largely independent of the speed of operation. It is normally less than 20 ms (including bounce times of less than 5 ms).

#### Operating speed and maximum usable operating rate

Our miniature snap switches are suitable for a wide range of operating speeds: generally, from 1 mm/mn to 1 m/s (0.04 in/mn to 3.28 ft/s). The maximum usable operating rate on a light electrical load may be as high as 10 operations/second.

#### Mounting and operation

To conform to the leakage paths and air gaps in standards EEC 24 - EN/IEC 61058 and EN/IEC 60947:

- an insulation pad must be inserted between the snap switch and the mounting surface if the latter is metal,
- manual operation of a metal actuator must only be carried out with the aid of an intermediate actuator made of an insulating material.
- The installer must ensure adequate protection against direct contact with the output terminals.

#### Actuation method

**Direct operation:** The plunger should preferably be actuated along its axis. However, the majority of our miniature snap switches will accept skewed operation provided the angle of actuation is not more than 45°.

The travel of the actuator must not be limited to only reaching the tripping point. The actuator must always be operated in such a manner that the plunger reaches a point at least 0.5 times the stated overtravel value of the switch. Also, it should not reach its end of travel nor exceed the maximum permissible end-of-travel force.

# Limit Switches

## Osiswitch® Miniature Snap Switches

### XEP and XC0

#### Mounting (continued)

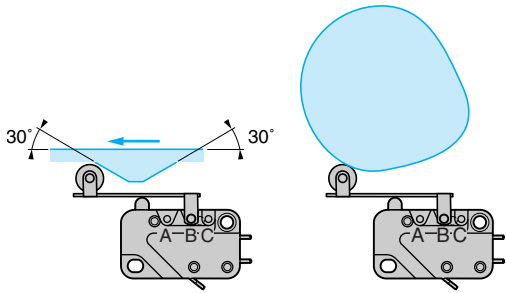

#### Actuation method (continued)

Lever operators:

- when actuation is by a roller lever, force should preferably be applied in the direction shown in the diagrams opposite,
- where the movements involved are fast, the ramp should be so designed as to ensure that the operator is not subjected to any violent impact or abrupt release.

#### Mounting—Tightening torque

The tightening torque of the fixing screws must conform to the following values:

Ø of mounting screw		2	2.5	3	3.5	4
Tightening torque, N•cm (lb-in)	Maximum	25 (2.21)	35 (3.10)	60 (5.31)	100 (8.85)	150 (13.28)
	Minimum	15 (1.33)	25 (2.21)	40 (3.54)	60 (5.31)	100 (8.85)

#### Resistance to mechanical shock and vibration

- Resistance to shock and vibration depends on the mass of the moving parts and on the forces holding the contacts together.
- In general, for a miniature snap switch without accessory:
  - vibration > 10 gn, 10 to 500 Hz
  - shock > 50 gn 11 ms 1/2 sine wave

#### Electrical characteristics

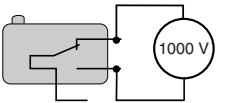
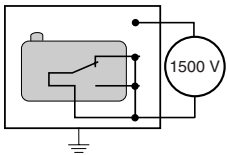
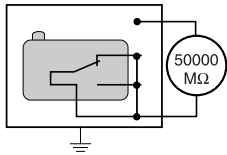
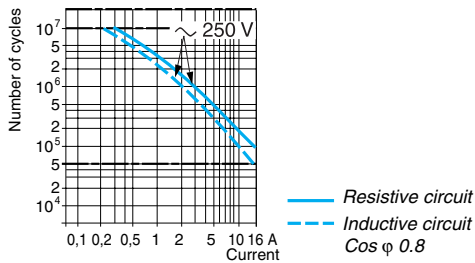

#### Operating curves

These indicate the electrical life of the miniature snap switches under standard conditions [20°C (68 °F), 1 cycle/2 seconds], by showing the number of switching operations which can be performed with given types of load. For sealed snap switches, the operating rate is 1 cycle/6 s.

#### Insulation resistance

The insulation resistance of the miniature snap switches is generally greater than 50,000 MΩ, measured at 500 Vdc

#### Dielectric strength

The dielectric strength of our miniature snap switches is generally superior to:

- 1500 V between live parts and earth
- 1000 V between contacts
- 600 V between contacts for switches with an inter-contact distance less than 0.3 mm

# Limit Switches

## Osiswitch® Miniature Snap Switches

Subminiature (DIN 41635 B format, sealed) and Sub-subminiature (DIN 41635 D format)

### Catalog numbers

Subminiature design, DIN 41635 B format, sealed

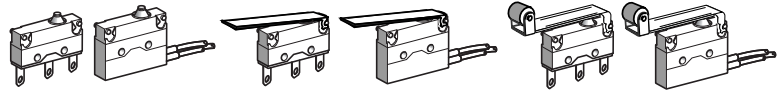

Type of operator	Plunger	Flat lever (1)	Roller lever (1)	
<p>Single-pole C/O snap action Wiring: 1 Black 2 Grey 4 Blue</p>	2.8 mm (0.11 in.) cable clip tag connections <b>XEP4E1W7 (3)</b>	<b>XEP4E1W7A326 (3)</b>	<b>XEP4E1W7A454 (3)</b>	
	<b>Weight, g (oz)</b>	2.4 (0.08)	3.1 (0.11)	3.2 (0.11)
	Pre-cabled connections <b>XEP4E1FD (3)</b>	<b>XEP4E1FDA326 (3)</b>	<b>XEP4E1FDA454 (3)</b>	
<b>Separate components</b>	<b>Weight, g (oz)</b>	14.1 (0.50)	14.8 (0.52)	14.9 (0.53)
	Flat lever (2) <b>ZEP4L326 (3)</b>	—	—	—
	Roller lever (2) <b>ZEP4L454 (3)</b>	—	—	—
<b>Weight, g (oz)</b>	0.8 (0.03)	—	—	

Sub-subminiature design, DIN 41635D format



Type of operator	Plunger	Flat lever (1)
<p>Single-pole C/O snap action</p>	<b>XEP5P1W2 (3)</b>	<b>XEP5P1W2Z55B (3)</b>
<b>Weight, g (oz)</b>	1.4 (0.05)	1.9 (0.07)

### Dimensions

XEP4E1W7

XEP4E1W7A326

XEP4E1W7A454

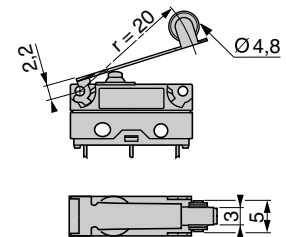
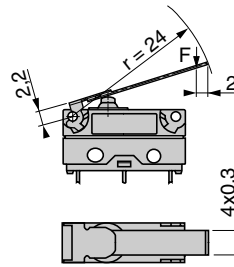
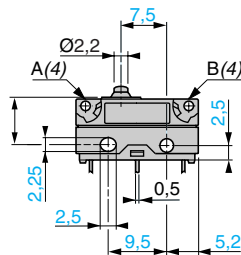
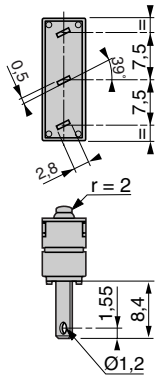

XEP4E1FD

XEP4E1FDA326

XEP4E1FDA454

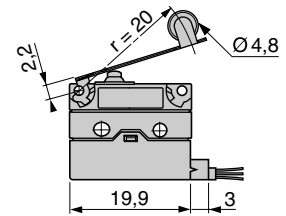
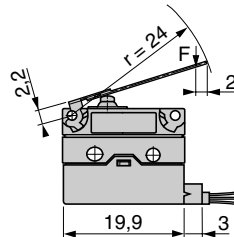
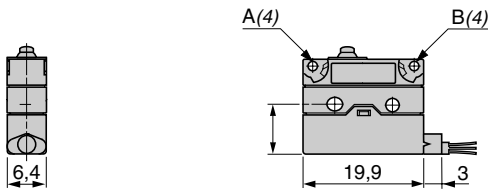

XEP5P1W2

XEP5P1W2Z55B

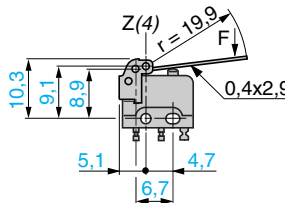
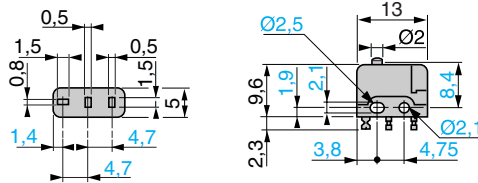

1. To avoid damage to the mounting spigots, removal of the lever from complete products is not recommended.  
2. Levers only for mounting on basic (plunger) snap switches (XEP4E1W7 and XEP4E1FD).

3. Switches sold in lots of 5.  
4. A, B, Z: lever fixing positions.

# Limit Switches

## Osiswitch® Miniature Snap Switches

### Subminiature (DIN 41635 B format, sealed) and Sub-subminiature (DIN 41635 D format)

Switch type	XEP4E1**, XEP5P1W2 Plunger	XEP4E1**A326, XEP5P1W2Z55B Flat lever	XEP4E1**A454 Roller lever			
<b>Environment characteristics</b>						
Lever fixing position (1)	—	A	A			
Switch actuation	On end	Horizontal				
Product certifications	CE, IEC 60947-5-1, EN 60947-5-1, c UR us, UL 1054, EN 61058					
Degree of protection	IP 67 XEP4E1FD**, case IP 67 and tags IP 00 XEP4E1W7**, case IP 40 and tags IP 00 XEP5P1W2**					
Operating temperature	-40...+105 °C XEP4E1FD**, -40...+125 °C XEP4E1W*** and XEP5P1***					
Materials	Enclosure	Polyester XEP4, diallyl-phthalate XEP5				
	Lever	—	Stainless steel			
	Contact	AgCdO XEP4E1**, Ag XEP5				
	Tags	Tinned brass XEP4E1W***, gold plated brass XEP5P1**				
<b>Mechanical characteristics</b>						
Maximum tripping force, N (oz)	XEP4	Lever fixing position (1)	A	2.5 N (8.99 oz)	0.63 N (2.27 oz)	0.83 N (2.99 oz)
		B	2.5 N (8.99 oz)	1.25 N (4.50 oz)	1.67 N (6.01 oz)	
Minimum release force, N (oz)	XEP4	A	0.80 N (2.88 oz)	0.20 N (0.72 oz)	0.27 N (0.97 oz)	
		B	0.80 N (2.88 oz)	0.40 N (1.44 oz)	0.53 N (1.91 oz)	
Maximum permissible end of travel force, N (lb)	XEP4	A	10 N (2.25 lb)	2.5 N (0.56 lb)	3.33 N (0.75 lb)	
		B	10 N (2.25 lb)	5 N (1.12 lb)	6.67 N (1.50 lb)	
Tripping point (TP) (2)	XEP4	A	8.40 $\pm$ 0.3 mm	10.7 $\pm$ 1.7 mm	15.5 $\pm$ 1.4 mm	
		B	8.40 $\pm$ 0.3 mm	9.6 $\pm$ 1.0 mm	14.5 $\pm$ 0.9 mm	
Maximum differential travel	XEP4	A	0.13 mm	0.52 mm	0.39 mm	
		B	0.13 mm	0.26 mm	0.20 mm	
Minimum overtravel	XEP4	A	0.60 mm	2.40 mm	1.80 mm	
		B	0.60 mm	1.20 mm	0.90 mm	
Inter-contact distance	XEP4	A	0.10 mm	—	—	
		B	0.4 mm	—	—	
Mechanical durability	XEP4	A	2 million operating cycles	—	—	
		B	0.1 million operating cycles	—	—	
Operational characteristics	XEP4	A	AC-15: B300 (Ue: 240 V, Ie: 1.5 A) DC-13: R300 (Ue: 250 V, Ie: 0.1 A) conforming to IEC 60947-5-1, EN 60947-5-1 Appendix A 125-250 Vac 6.0 A conforming to UL 1054 6 (1) A 250 Vac 10,000 cycles conforming to EN 61058	—	—	
		B	AC-15: D300 (Ue: 240 V, Ie: 0.3 A) conforming to IEC 60947-5-1, EN 60947-5-1 Appendix A	—	—	
Thermal current	XEP4	A	7.5 A on 250 V (50/60 Hz)	—	—	
		B	8.5 A on 250 V (50/60 Hz)	—	—	
Connection	XEP4	A	XEP4E1W7*: 2.8 mm (0.11 in.) cable clip tags XEP4E1FD: Pre-cabled (horizontally in-line), 3 x 0.5 mm <sup>2</sup> , length 0.5 m (1.6 ft)	—	—	
		B	Solder tags	—	—	

### Operating curves

XEP4E1\*\*

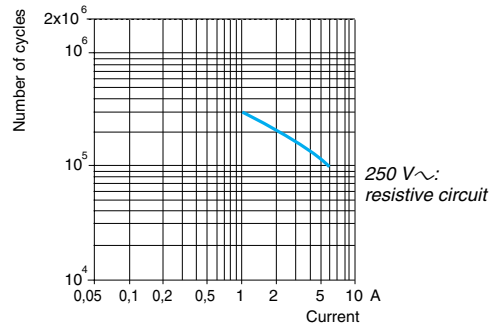

XEP5P1\*\*

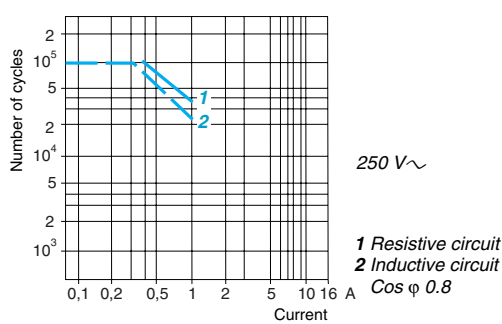

- Miniature snap switches fitted with a lever are supplied with the lever fixed in position A (see page 24).  
For basic (plunger) snap switches, it is possible to fix a lever in position A or B, depending on the required tripping conditions (see page 24).
- Position of the operator in relation to the switch mountings (mounting hole center line), at the instant the contact changes state.

# Limit Switches

## Osiswitch® Miniature Snap Switches

### Miniature (DIN 41635 A format)

#### Catalog numbers

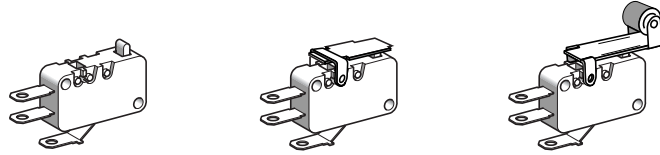

Type of operator		Plunger (2)	Flat lever (1) (2)	Roller lever (1) (2)
Single-pole C/O snap action	Standard contacts	Solder tags	XEP3S1W2	XEP3S1W2B524
		4.8 mm (0.19 in.) cable clip tags	XEP3S1W6	XEP3S1W6B524
		6.35 mm (0.25 in.) cable clip tags	XEP3S1W3	XEP3S1W3B524
	Very low operating force contacts	Solder tags	XEP3S2W2	XEP3S2W2B524
		4.8 mm (0.19 in.) cable clip tags	XEP3S2W6	XEP3S2W6B524
		6.35 mm (0.25 in.) cable clip tags	XEP3S2W3	XEP3S2W3B524
		Weight, g (oz)	5.6 (0.20)	6.3 (0.22)
		Weight, g (oz)	5.6 (0.20)	6.3 (0.22)
		Weight, g (oz)	5.6 (0.20)	6.3 (0.22)
Separate components		Flat lever (3)	ZEP3L524	
		Weight, g (oz)	0.7 (0.02)	
		Roller lever (3)	ZEP3L529	
		Weight, g (oz)	1 (0.04)	

#### Dimensions

##### XEP3S•W2

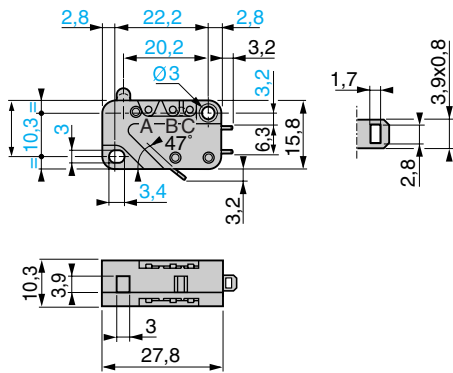

##### XEP3S•W6

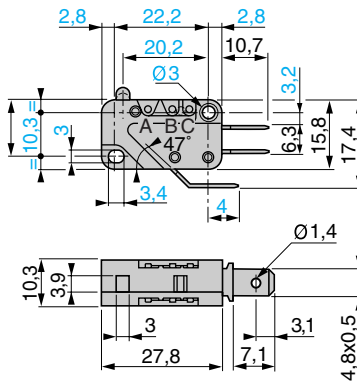

##### XEP3S•W3

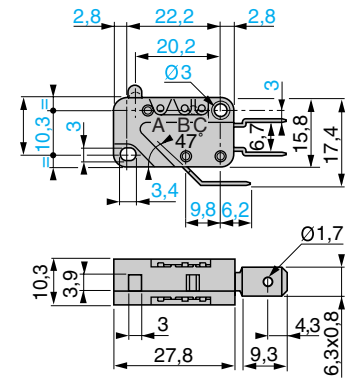

##### ZEP3L529

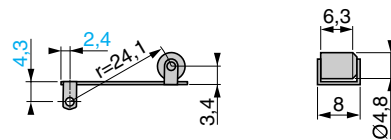

##### ZEP3L524

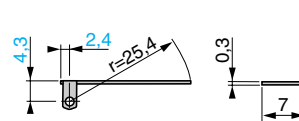

- To avoid damage to the mounting spigots, removal of the lever from complete products is not recommended.
- Switches sold in lots of 10.
- Levers only for mounting on basic (plunger) snap switches (XEP3S•W2, XEP3S•W3 and XEP3S•W6), in mounting positions A, B or C.

# Limit Switches

## Osiswitch® Miniature Snap Switches

### Miniature (DIN 41635 A format)

Switch type	XEP3 S-W2	XEP3 S-W2B254	XEP3 S-W2B259
Type of operator	Plunger	Flat lever	Roller lever
<b>Environment characteristics</b>			
Lever fixing position (1)	—	B	B
Switch actuation	On end	Horizontal	
Product certifications	UR us, c€, IEC/EN 60947-5-1, UL 1054, EN 61058-1		
Degree of protection	Case IP 40 and tags IP 00		
Operating temperature	- 25...+ 125 °C		
Materials	Enclosure	Polyester	
	Lever	—	Stainless steel
	Contact	AgNi	Stainless steel, glass reinforced polyamide roller

<b>Mechanical characteristics</b>			
Lever fixing position (1)			
Maximum tripping force, N (oz)	Standard	A	0.80 N (2.88 oz)
		B	0.80 N (2.88 oz)
		C	0.80 N (2.88 oz)
	Very low force	A	0.25 N (0.90 oz)
		B	0.25 N (0.90 oz)
		C	0.25 N (0.90 oz)
Minimum release force, N (oz)	Standard	A	0.20 N (0.72 oz)
		B	0.20 N (0.72 oz)
		C	0.20 N (0.72 oz)
	Very low force	A	0.05 N (0.18 oz)
		B	0.05 N (0.18 oz)
		C	0.05 N (0.18 oz)
Maximum permissible end of travel force, N (lb)	Standard, very low force	A	20 N (4.50 lb)
		B	20 N (4.50 lb)
		C	20 N (4.50 lb)
Tripping point (TP) (2)	Standard, very low force	A	14.70 <sup>+/-0.4</sup> mm
		B	14.70 <sup>+/-0.4</sup> mm
		C	14.70 <sup>+/-0.4</sup> mm
Maximum differential travel	Standard, very low force	A	0.35 mm
		B	0.35 mm
		C	0.35 mm
Minimum overtravel	Standard	A	1.20 mm
		B	1.20 mm
		C	1.20 mm
	Very low force	A	1.10 mm
		B	1.10 mm
		C	1.10 mm
Inter-contact distance		0.40 mm	
Mechanical durability for 2/3 overtravel	Standard	20 million operating cycles	
	Very low force	50 million operating cycles	

<b>Electrical characteristics</b>			
Operational characteristics	Standard	AC-15: B300 (Ue: 240 V, Ie: 1.5 A) DC-13: R300 (Ue: 250 V, Ie: 0.1 A) conforming to IEC/EN 60947-5-1 Appendix A 125-250 Vac 10.1 A—1/2 HP conforming to UL 1054 12 (3) A 250 Vac 10,000 cycles conforming to EN 61058-1	
	Very low force	AC-15: D300 (Ue: 240 V, Ie: 0.3 A) conforming to IEC/EN 60947-5-1 Appendix A 125-250 Vac 4 A—1/10 HP conforming to UL 1054 4 (1) A 250 Vac 50,000 cycles conforming to EN 61058-1	
Thermal current	Standard	15 A on 250 V (50/60 Hz)	
	Very low force	5 A on 250 V (50/60 Hz)	
Connection	XEP3 S-W2: solder tags, XEP3 S-W6: 4.8 mm (0.19 in.) cable clip tags XEP3 S-W3: 6.35 mm (0.25 in.) cable clip tags.		

### Operating curves

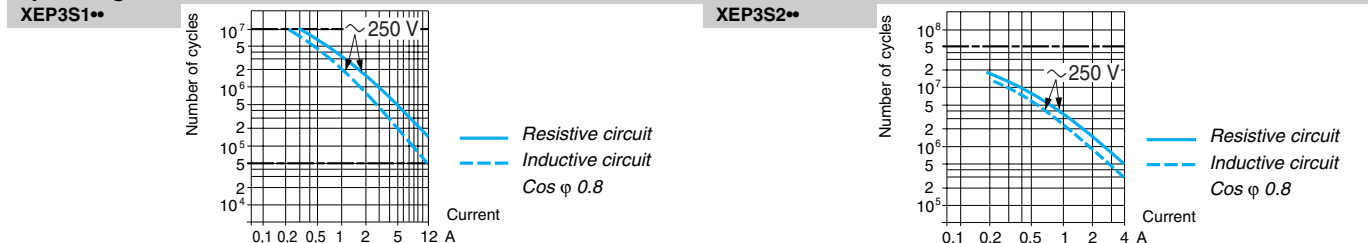

- Miniature snap switches fitted with a lever are supplied with the lever fixed in position B (see page 26). For basic (plunger) snap switches, it is possible to fix a lever in position A, B or C, depending on the required tripping conditions (see page 26).
- Position of the operator in relation to the switch mountings (mounting hole center line), at the instant the contact changes state.

# Limit Switches

## Osiswitch® Miniature Snap Switches

### Sealed Design Pre-Cabled

Type of head Plunger (mounting by the body)

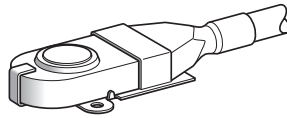

Head with flat plunger

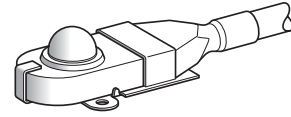

Head with domed encased plunger

Type of operator

Catalog numbers

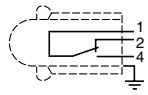

Single-pole C/O snap action  
Wiring:  
1 Black  
2 Brown  
4 Blue

**XC010L2**

**XC011L2**

Weight, kg (lb)

0.145 (0.320)

0.150 (0.331)

### Dimensions

XC010L2

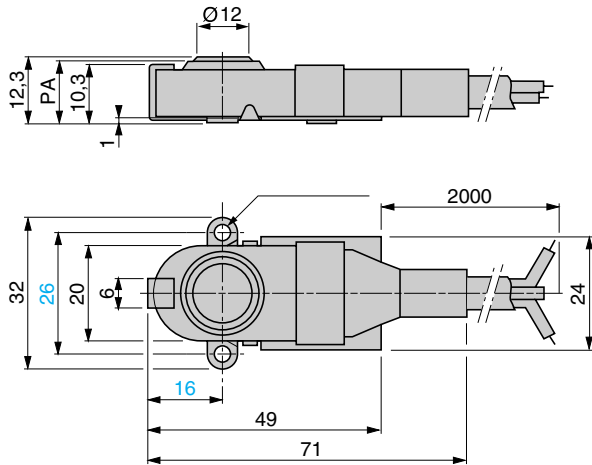

XC011L2

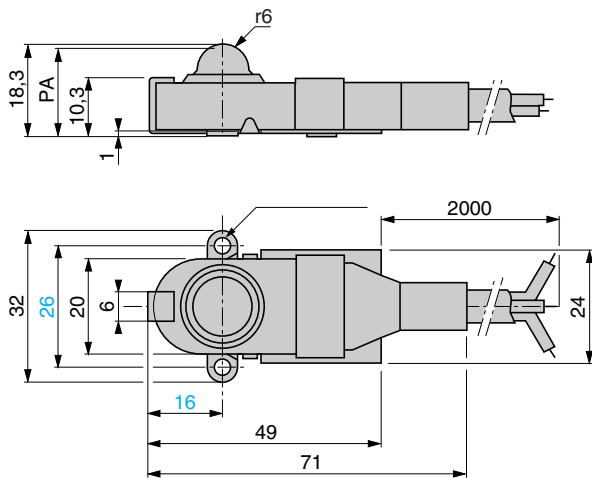



# Limit Switches

## Osiswitch® Miniature Snap Switches

### Sealed Design Pre-Cabled

Switch type	XC010•	XC011•
<b>Environment characteristics</b>		
Switch actuation	On end, flat plunger (1)	On end, domed plunger (1)
Product certifications	CE, IEC 60947-5-1	
Degree of protection	IP 66	
Operating temperature	0...85 °C (32...185 °F)	
Materials	Internal housing	Metal
	Casing	Nitrile
	Mounting support	Steel, zinc passivated
	Contact	Ag
<b>Mechanical characteristics</b>		
Maximum tripping force	5.3 N (1.19 lb)	
Minimum release force	1.5 N (0.34 lb)	
Maximum permissible end of travel force	30 N (6.74 lb)	
Tripping point (TP) (2)	11.4 <sup>±0.4</sup> mm	17.4 <sup>±0.5</sup> mm
Maximum differential travel	0.2 mm	
Minimum overtravel	0.2 mm	
Inter-contact distance	0.5 mm	
Mechanical durability	2 million operating cycles	
<b>Electrical characteristics</b>		
Operational current	1 A on 24 V (50/60 Hz)	
Thermal current/insulation voltage	12 A/60 V	
Connection	A05 VVF cable, 3 x 0.75 mm <sup>2</sup> , length 2 m (6.6 ft), overall diameter ≤ 7.6 mm (0.30 in.)	
Electrical durability	AC-15: 0.5 million operating cycles	
<b>Operating curve</b>		

- Manual actuation must be made by an intermediate insulated part, in order to meet basic safety requirements. One of the two mounting holes must also be used as an earth protection terminal.
- Distance between the base of the switch and the top of the plunger at the instant the contact changes state (see dimensions, page 28).

**Limit Switches**  
**Osistwitch® Miniature, Metal**  
**Universal, XCMD**

■ XCM D  
 pre-cabled

□ With head for linear movement (plunger). Mounting by the body.

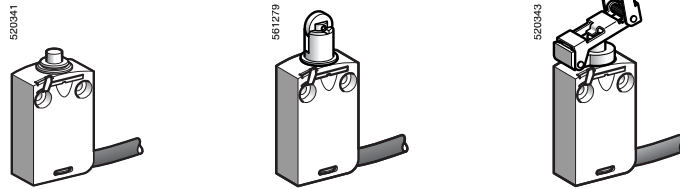

Page 32

□ With head for linear movement (plunger). Mounting by the head.

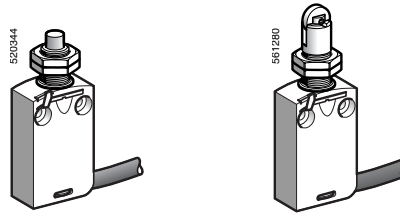

Page 32

□ With head for rotary movement (lever) or multi-directional. Mounting by the body.

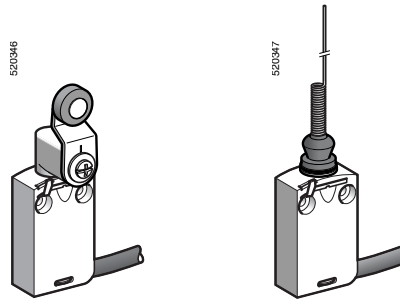

Page 33

■ XCM D  
 with integral connector

□ With head for linear movement (plunger)

Mounting by the body

Mounting by the head

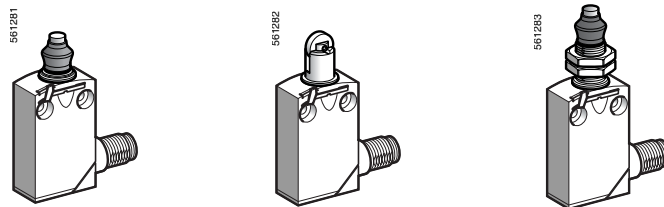

Page 36

□ With head for rotary movement (lever) or multi-directional. Mounting by the body.

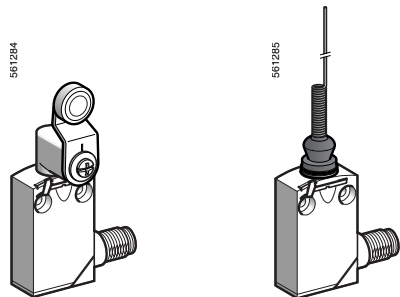

Page 37

# Limit Switches

## Osiswitch® Miniature, Metal

### Universal, XCMD

Environment characteristics																																									
Conforming to standards	Products	IEC 60947-5-1, EN 60947-5-1, UL 508, CSA C22-2 n° 14																																							
	Machine assemblies	IEC 60204-1, EN 60204-1																																							
Product certifications		UL, CSA (except products with special cables), CCC																																							
Protective treatment		Standard version: "TC"																																							
Ambient air temperature		Operation: -25...+70 °C (-13...+158 °F). Storage: -40...+70 °C (-40...+158 °F)																																							
Vibration resistance		XCMD snap action: 5 gn. XCMD slow break: 25 gn (10...500 Hz) conforming to IEC 60068-2-6																																							
Shock resistance		25 gn (18 ms) conforming to IEC 60068-2-27																																							
Electric shock protection		Class I conforming to IEC 61-140 and NF C 20-030																																							
Degree of protection		NEMA Types 1, 2, 4, 12, 13 IP 66, IP 67 and IP 68 (1) conforming to IEC 60529 IK 06 conforming to EN 50102																																							
Materials		Bodies and heads: Zamak® zinc alloy																																							
Repeat accuracy		0.05 mm on the tripping points, with 1 million operating cycles for head with end plunger																																							
Protection against prolonged immersion: the test conditions are subject to agreement between the manufacturer and the user.																																									
Contact block characteristics																																									
Rated operational characteristics	Switches with 2 contacts	~ AC-15; B300 (Ue = 240 V, Ie = 1.5 A) = DC-13; R300 (Ue = 250 V, Ie = 0.1 A), conforming to IEC 60947-5-1 Appendix A, EN 60947-5-1																																							
	Switches with 3 and 4 contacts	~ AC-15; C300 (Ue = 240 V, Ie = 0.75 A) = DC-13; R300 (Ue = 250 V, Ie = 0.1 A), conforming to IEC 60947-5-1 Appendix A, EN 60947-5-1																																							
	Pre-cabled switches	Ithe = 6 A for 2 contacts, 4 A for 3 contacts, 3 A for 4 contacts																																							
	Switches with 4-pin M12 connector	Ui = 250 V, Ie = 3 A maximum, Ithe = 3 A																																							
	Switches with 5-pin M12 connector	Ui = 60 V, Ie = 4 A maximum, Ithe = 4 A																																							
	Switches with 5-pin 7/8" 16UN connector	Ui = 250 V, Ie = 6 A maximum, Ithe = 6 A																																							
Rated insulation voltage		Ui = 400 V degree of pollution 3 conforming to IEC 60947-5-1 Ui = 300 V conforming to UL 508, CSA C22-2 n° 14																																							
Rated impulse withstand voltage		U imp = 4 kV conforming to IEC 60947-1, IEC 60664																																							
Positive operation (depending on model)		N/C contacts with positive opening operation conforming to IEC 60947-5-1 Appendix K, EN 60947-5-1																																							
Resistance across terminals		≤ 25 mΩ conforming to IEC 60255-7 category 3																																							
Electric shock protection		6 A cartridge fuse type gG (gl)																																							
Minimum actuation speed		Snap action contact: 0.01 m/minute (0.03 ft/minute) Slow break contact: 6 m/minute (19.68 ft/minute)																																							
Electrical durability		<ul style="list-style-type: none"> <li>Conforming to IEC 60947-5-1 Appendix C</li> <li>Utilization categories AC-15 and DC-13</li> <li>Maximum operating rate: 3600 operating cycles/hour</li> <li>Load factor: 0.5</li> </ul>																																							
		<table border="0"> <tr> <td></td> <td> <p><b>XCMD snap action (N/C + N/O, N/C + N/C, N/C + N/C + N/O, N/C + N/C + N/O + N/O contacts)</b></p> </td> <td> <p><b>XCMD slow break (N/C + N/O, N/C + N/C + N/O contacts)</b></p> </td> </tr> <tr> <td>a.c. supply ~ 50/60 Hz m inductive circuit</td> <td></td> <td></td> </tr> <tr> <td>d.c. supply =</td> <td> <table border="1"> <thead> <tr> <th colspan="5">Power switched in W for 5 million operating cycles</th> </tr> <tr> <th>Voltage</th> <th>V</th> <th>24</th> <th>48</th> <th>120</th> </tr> <tr> <th>m</th> <th>W</th> <td>3</td> <td>2</td> <td>1</td> </tr> </thead> </table> </td> <td> <table border="1"> <thead> <tr> <th colspan="5">Power switched in W for 5 million operating cycles</th> </tr> <tr> <th>Voltage</th> <th>V</th> <th>24</th> <th>48</th> <th>120</th> </tr> <tr> <th>m</th> <th>W</th> <td>4</td> <td>3</td> <td>3</td> </tr> </thead> </table> </td> </tr> </table>		<p><b>XCMD snap action (N/C + N/O, N/C + N/C, N/C + N/C + N/O, N/C + N/C + N/O + N/O contacts)</b></p>	<p><b>XCMD slow break (N/C + N/O, N/C + N/C + N/O contacts)</b></p>	a.c. supply ~ 50/60 Hz m inductive circuit			d.c. supply =	<table border="1"> <thead> <tr> <th colspan="5">Power switched in W for 5 million operating cycles</th> </tr> <tr> <th>Voltage</th> <th>V</th> <th>24</th> <th>48</th> <th>120</th> </tr> <tr> <th>m</th> <th>W</th> <td>3</td> <td>2</td> <td>1</td> </tr> </thead> </table>	Power switched in W for 5 million operating cycles					Voltage	V	24	48	120	m	W	3	2	1	<table border="1"> <thead> <tr> <th colspan="5">Power switched in W for 5 million operating cycles</th> </tr> <tr> <th>Voltage</th> <th>V</th> <th>24</th> <th>48</th> <th>120</th> </tr> <tr> <th>m</th> <th>W</th> <td>4</td> <td>3</td> <td>3</td> </tr> </thead> </table>	Power switched in W for 5 million operating cycles					Voltage	V	24	48	120	m	W	4	3	3
	<p><b>XCMD snap action (N/C + N/O, N/C + N/C, N/C + N/C + N/O, N/C + N/C + N/O + N/O contacts)</b></p>	<p><b>XCMD slow break (N/C + N/O, N/C + N/C + N/O contacts)</b></p>																																							
a.c. supply ~ 50/60 Hz m inductive circuit																																									
d.c. supply =	<table border="1"> <thead> <tr> <th colspan="5">Power switched in W for 5 million operating cycles</th> </tr> <tr> <th>Voltage</th> <th>V</th> <th>24</th> <th>48</th> <th>120</th> </tr> <tr> <th>m</th> <th>W</th> <td>3</td> <td>2</td> <td>1</td> </tr> </thead> </table>	Power switched in W for 5 million operating cycles					Voltage	V	24	48	120	m	W	3	2	1	<table border="1"> <thead> <tr> <th colspan="5">Power switched in W for 5 million operating cycles</th> </tr> <tr> <th>Voltage</th> <th>V</th> <th>24</th> <th>48</th> <th>120</th> </tr> <tr> <th>m</th> <th>W</th> <td>4</td> <td>3</td> <td>3</td> </tr> </thead> </table>	Power switched in W for 5 million operating cycles					Voltage	V	24	48	120	m	W	4	3	3									
Power switched in W for 5 million operating cycles																																									
Voltage	V	24	48	120																																					
m	W	3	2	1																																					
Power switched in W for 5 million operating cycles																																									
Voltage	V	24	48	120																																					
m	W	4	3	3																																					

# Limit Switches

## Osiswitch® Miniature, Metal

### Universal, XCMD, Pre-Cabled

Type of head      Plunger (mounting by the body)      Plunger (mounting by the head)

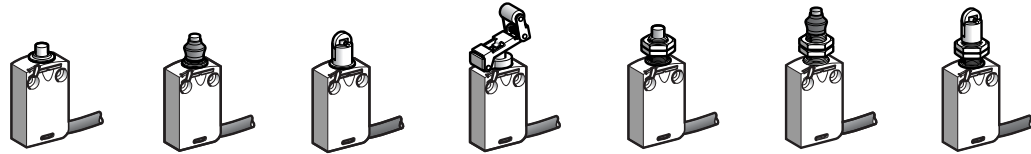

Type of operator	Metal end plunger	Metal end plunger with elastomer boot	Steel roller plunger	Retractable steel roller lever plunger	M12 with metal end plunger	M16 with metal end plunger with elastomer boot	M12 with steel roller plunger
------------------	-------------------	---------------------------------------	----------------------	--	----------------------------	--	-------------------------------

### Catalog numbers

<b>2-pole N/C + N/O snap action</b> 	<b>XCMD2110L1</b> 	<b>XCMD2111L1</b> 	<b>XCMD2102L1</b> 	<b>XCMD2124L1</b> 	<b>XCMD21F0L1</b> 	<b>XCMD21G1L1</b> 	<b>XCMD21F2L1</b> 
<b>2-pole N/C + N/O break before make, slow break</b> 	<b>XCMD2510L1</b> 	<b>XCMD2511L1</b> 	<b>XCMD2502L1</b> 	<b>XCMD2524L1</b> 	<b>XCMD25F0L1</b> 	<b>XCMD25G1L1</b> 	<b>XCMD25F2L1</b> 
<b>2-pole N/C + N/C snap action</b> 	<b>ZCMD29L1 + ZCE10</b> 	<b>ZCMD29L1 + ZCE11</b> 	<b>ZCMD29L1 + ZCE02</b> 	<b>ZCMD29L1 + ZCE24</b> 	<b>ZCMD29L1 + ZCEF0</b> 	<b>ZCMD29L1 + ZCEG1</b> 	<b>ZCMD29L1 + ZCEF2</b> 
<b>3-pole N/C + N/C + N/O snap action</b> 	<b>ZCMD39L1 + ZCE10</b> 	<b>ZCMD39L1 + ZCE11</b> 	<b>ZCMD39L1 + ZCE02</b> 	<b>ZCMD39L1 + ZCE24</b> 	<b>ZCMD39L1 + ZCEF0</b> 	<b>ZCMD39L1 + ZCEG1</b> 	<b>ZCMD39L1 + ZCEF2</b> 
<b>3-pole N/C + N/C + N/O break before make, slow break</b> 	<b>ZCMD37L1 + ZCE10</b> 	<b>ZCMD37L1 + ZCE11</b> 	<b>ZCMD37L1 + ZCE02</b> 	<b>ZCMD37L1 + ZCE24</b> 	<b>ZCMD37L1 + ZCEF0</b> 	<b>ZCMD37L1 + ZCEG1</b> 	<b>ZCMD37L1 + ZCEF2</b> 
<b>Weight, kg (lb)</b>	0.180 (0.397)	0.180 (0.397)	0.185 (0.408)	0.200 (0.441)	0.195 (0.430)	0.220 (0.485)	0.205 (0.452)
<b>4-pole N/C + N/C + N/O + N/O snap action</b> 	<b>ZCMD41L1 + ZCE10</b> 	<b>ZCMD41L1 + ZCE11</b> 	<b>ZCMD41L1 + ZCE02</b> 	<b>ZCMD41L1 + ZCE24</b> 	<b>ZCMD41L1 + ZCEF0</b> 	<b>ZCMD41L1 + ZCEG1</b> 	<b>ZCMD41L1 + ZCEF2</b> 
<b>Weight, kg (lb)</b>	0.160 (0.353)	0.160 (0.353)	0.165 (0.364)	0.180 (0.397)	0.175 (0.386)	0.200 (0.441)	0.185 (0.408)

**Contact operation**  

 (A) = cam displacement      ⊕ N/C contact with positive opening operation, when properly mounted and using a conforming operator  
 (P) = positive opening point

### Characteristics

<b>Switch actuation</b>	On end	By 30° cam		On end	By 30° cam	
<b>Type of actuation</b>						
<b>Maximum actuation speed</b>	0.5 m/s (1.64 ft/s)			0.1 m/s (0.33 ft/s)		
<b>Minimum force or torque</b>	For tripping	8.5 N (1.91 lb)	7 N (1.57 lb)	2.5 N (0.56 lb)	8.5 N (1.91 lb)	7 N (1.57 lb)
	For positive opening	42.5 N (9.55 lb)	35 N (7.87 lb)	12.5 N (2.81 lb)	42.5 N (9.55 lb)	35 N (7.87 lb)

**Cabling** PvR cable, 1 m (3.3 ft) long: 5 x 0.75 mm<sup>2</sup> for 2-pole contact versions; 7 x 0.5 mm<sup>2</sup> for 3-pole contact versions; 9 x 0.34 mm<sup>2</sup> for 4-pole contact versions. For other cable lengths, see page 42.

NOTE: For more information, consult pages 38–40.

# Limit Switches

## Osiswitch® Miniature, Metal

### Universal, XCMD, Pre-Cabled

Type of head	Rotary (mounting by the body)			Multi-directional	
<b>Type of operator</b>	Thermoplastic roller lever	Steel roller lever	Roller lever with ball bearing mounted roller	Variable length thermoplastic roller lever	Cat's whisker (1)
<b>Catalog numbers</b>					
<b>2-pole N/C + N/O snap action</b>	 XCMD2115L1	 XCMD2116L1	 XCMD2117L1	 XCMD2145L1	 XCMD2106L1
<b>2-pole N/C + N/O break before make, slow break</b>	 XCMD2515L1	 XCMD2516L1	 XCMD2517L1	 XCMD2545L1	 XCMD2506L1
<b>2-pole N/C + N/C snap action</b>	 ZCMD29L1 + ZCE01 + ZCY15	 ZCMD29L1 + ZCE01 + ZCY16	 ZCMD29L1 + ZCE01 + ZCY17	 ZCMD29L1 + ZCE01 + ZCY45	 ZCMD29L1 + ZCE06
<b>3-pole N/C + N/C + N/O snap action</b>	 ZCMD39L1 + ZCE01 + ZCY15	 ZCMD39L1 + ZCE01 + ZCY16	 ZCMD39L1 + ZCE01 + ZCY17	 ZCMD39L1 + ZCE01 + ZCY45	 ZCMD39L1 + ZCE06
<b>3-pole N/C + N/C + N/O break before make, slow break</b>	 ZCMD37L1 + ZCE01 + ZCY15	 ZCMD37L1 + ZCE01 + ZCY16	 ZCMD37L1 + ZCE01 + ZCY17	 ZCMD37L1 + ZCE01 + ZCY45	 ZCMD37L1 + ZCE06
<b>Weight, kg (lb)</b>	0.220 (0.485)	0.225 (0.496)	0.220 (0.485)	0.230 (0.507)	0.180 (0.397)
<b>4-pole N/C + N/C + N/O + N/O snap action</b>	 ZCMD41L1 + ZCE01 + ZCY15	 ZCMD41L1 + ZCE01 + ZCY16	 ZCMD41L1 + ZCE01 + ZCY17	 ZCMD41L1 + ZCE01 + ZCY45	 ZCMD41L1 + ZCE06
<b>Weight, kg (lb)</b>	0.200 (0.441)	0.205 (0.452)	0.200 (0.441)	0.210 (0.463)	0.160 (0.353)
<b>Contact operation</b>	contact closed (A) = cam displacement contact open (P) = positive opening point			N/C contact with positive opening operation, when properly mounted and using a conforming operator	
1. Value taken with actuation by moving part at 100 mm (3.94 in.) from the mountings.					
<b>Characteristics</b>					
<b>Switch actuation</b>	By 30° cam			By any moving part	
<b>Type of actuation</b>					
<b>Maximum actuation speed</b>	1.5 m/s (4.92 ft/s)			1 m/s (3.28 ft/s)	
<b>Minimum force or torque</b>	For tripping	0.1 N*m (0.89 lb-in)			
	For positive opening	0.5 N*m (4.43 lb-in)			
<b>Cabling</b>	PvR cable, 1 m (3.3 ft) long: 5 x 0.75 mm <sup>2</sup> for 2-pole contact versions; 7 x 0.5 mm <sup>2</sup> for 3-pole contact versions, 9 x 0.34 mm <sup>2</sup> for 4-pole contact versions. For other cable lengths, see page 42.				

NOTE: For more information, consult pages 38–40.

# Limit Switches

## Osiswitch® Miniature, Metal

### Universal, XCMD, Pre-Cabled—Dimensions

XCMD2•10L1

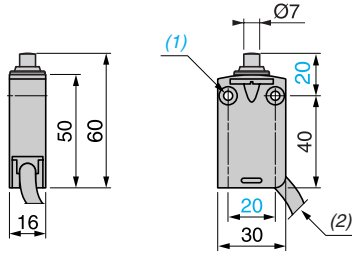

XCMD2•11L1

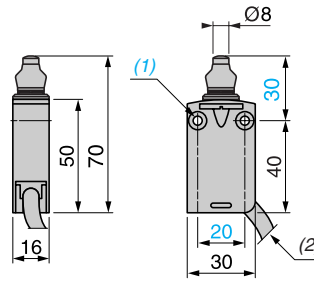

XCMD2•02L1

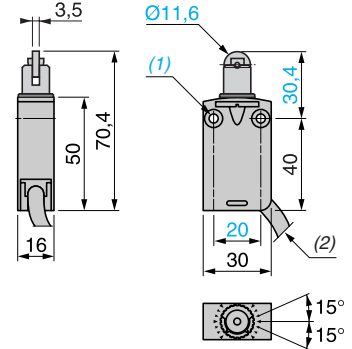

XCMD2•24L1

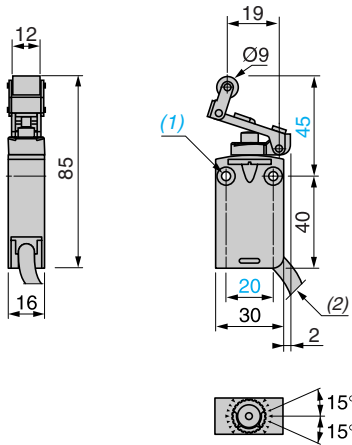

XCMD2•F0L1

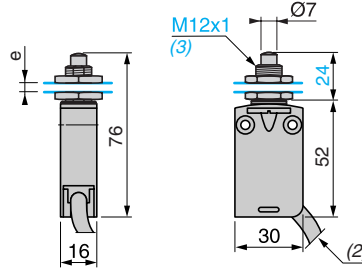

XCMD2•G1L1

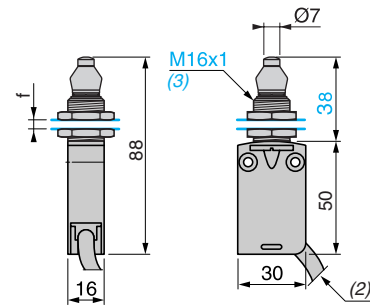

XCMD2•F2L1

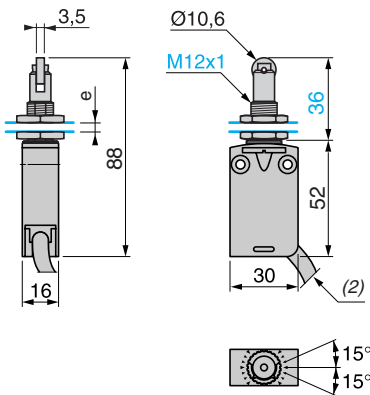

1. 2 mounting holes  $\text{Ø} 4.2 \text{ mm}$  (0.17 in.), counterbored  $\text{Ø} 8 \text{ mm}$  (0.31 in.) by  $4 \text{ mm}$  (0.16 in.) deep.
2. Overall diameter of cable  $7.5 \text{ mm}$  (0.30 in.).
3. Mounting nut thickness  $3.5 \text{ mm}$  (0.14 in.).
- e:  $8 \text{ mm}$  (0.31 in.) max, panel cut-out  $\text{Ø} 12.5 \text{ mm}$  (0.49 in.).
- f:  $8 \text{ mm}$  (0.31 in.) max, panel cut-out  $\text{Ø} 16.5 \text{ mm}$  (0.65 in.).

# Limit Switches

## Osiswitch® Miniature, Metal

### Universal, XCMD, Pre-Cabled—Dimensions

XCMD2•15L1

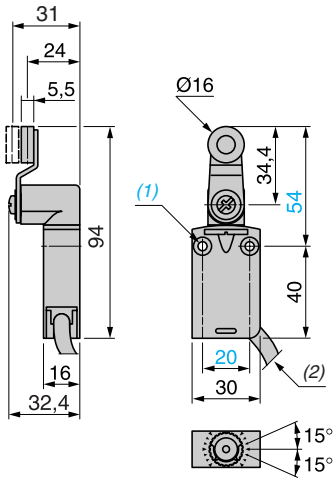

XCMD2•16L1

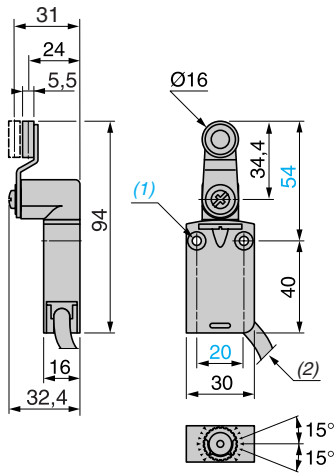

XCMD2•17L1

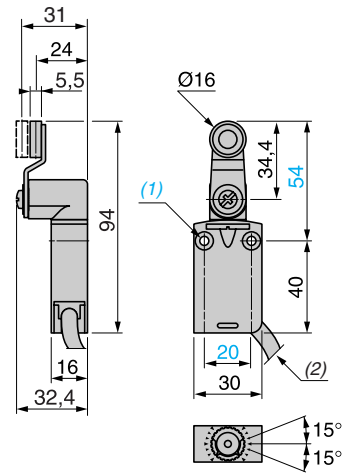

XCMD2•45L1

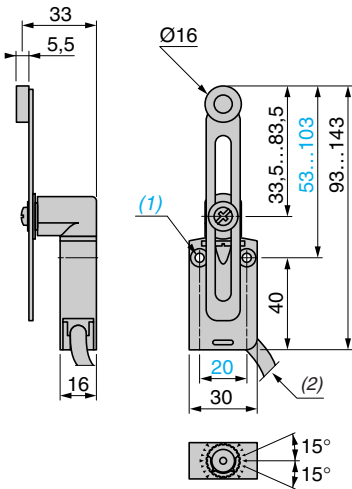

XCMD2•06L1

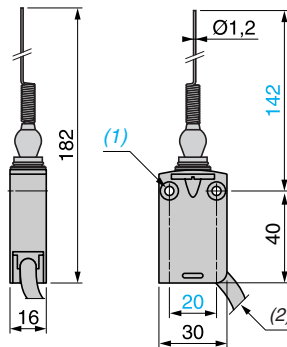

- 1. 2 mounting holes  $\varnothing 4.2$  mm (0.17 in.), counterbored  $\varnothing 8$  mm (0.31 in.) by 4 mm (0.16 in.) deep.
- 2. Overall diameter of cable 7.5 mm (0.30 in.).
- e: 8 mm (0.31 in.) max, panel cut-out  $\varnothing 12.5$  mm (0.49 in.).
- f: 8 mm (0.31 in.) max, panel cut-out  $\varnothing 16.5$  mm (0.65 in.).

# Limit Switches

## Osiswitch® Miniature, Metal

### Universal, XCMD, Integral or Remote Connector

Type of head      Plunger (mounting by the body)      Plunger (mounting by the head)

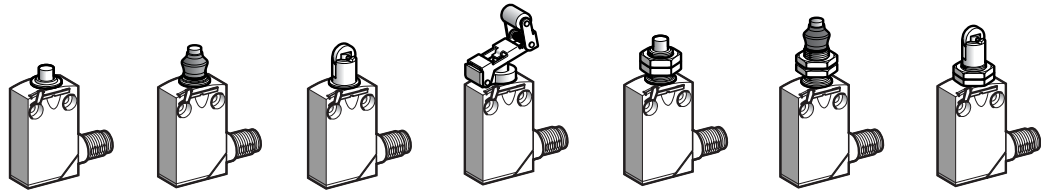

Type of operator      Metal end plunger      Metal end plunger with elastomer boot      Steel roller plunger      Retractable steel roller lever plunger      M12 with metal end plunger      M16 with metal end plunger with elastomer boot      M12 with steel roller plunger

#### Catalog numbers

<p>Single-pole C/O snap action + integral M12 4-pin connector</p>	<p>XCMD2110M12 1,8 4,2(P) 0,8 5mm</p>	<p>XCMD2111M12 1,8 4,2(P) 0,8 5mm</p>	<p>XCMD2102M12 3,1(A) 7(P) 1,4 mm</p>	<p>XCMD2124M12 11,2(A) 25(P) 0 4,9 mm</p>	<p>XCMD21F0M12 1,8 4,2(P) 0,8 5mm</p>	<p>XCMD21G1M12 1,8 4,2(P) 0,8 5mm</p>	<p>XCMD21F2M12 3,1(A) 7(P) 1,4 mm</p>
<p>2-pole N/C + N/O snap action + integral M12 5-pin connector</p>	<p>XCMD2110C12 1,8 4,2(P) 0,8 5mm</p>	<p>XCMD2111C12 1,8 4,2(P) 0,8 5mm</p>	<p>XCMD2102C12 3,1(A) 7(P) 1,4 mm</p>	<p>XCMD2124C12 11,2(A) 25(P) 0 4,9 mm</p>	<p>XCMD21F0C12 1,8 4,2(P) 0,8 5mm</p>	<p>XCMD21G1C12 1,8 4,2(P) 0,8 5mm</p>	<p>XCMD21F2C12 3,1(A) 7(P) 1,4 mm</p>
<p>2-pole N/C + N/C snap action + integral M12 5-pin connector</p>	<p>ZCMD29C12 + ZCE10 1,8 4,2(P) 0,8 5mm</p>	<p>ZCMD29C12 + ZCE11 1,8 4,2(P) 0,8 5mm</p>	<p>ZCMD29C12 + ZCE02 3,1(A) 7(P) 1,4 mm</p>	<p>ZCMD29C12 + ZCE24 11,2(A) 25(P) 0 4,9 mm</p>	<p>ZCMD29C12 + ZCEF0 1,8 4,2(P) 0,8 5mm</p>	<p>ZCMD29C12 + ZCEG1 1,8 4,2(P) 0,8 5mm</p>	<p>ZCMD29C12 + ZCEF2 3,1(A) 7(P) 1,4 mm</p>
<p>Weight, kg (lb)</p>	0.085 (0.187)	0.085 (0.187)	0.090 (0.198)	0.105 (0.231)	0.100 (0.220)	0.125 (0.276)	0.110 (0.243)
<p>2-pole N/C + N/O snap action + M12 5-pin connector on 0.8 m (2.6 ft) flying lead</p>	<p>ZCMD21L08R12 + ZCE10 1,8 4,2(P) 0,8 5mm</p>	<p>ZCMD21L08R12 + ZCE11 1,8 4,2(P) 0,8 5mm</p>	<p>ZCMD21L08R12 + ZCE02 3,1(A) 7(P) 1,4 mm</p>	<p>ZCMD21L08R12 + ZCE24 11,2(A) 25(P) 0 4,9 mm</p>	<p>ZCMD21L08R12 + ZCEF0 1,8 4,2(P) 0,8 5mm</p>	<p>ZCMD21L08R12 + ZCEG1 1,8 4,2(P) 0,8 5mm</p>	<p>ZCMD21L08R12 + ZCEF2 3,1(A) 7(P) 1,4 mm</p>
<p>2-pole N/C + N/O snap action + 7/8" 16UN 5-pin connector on 0.8 m (2.6 ft) flying lead</p>	<p>ZCMD21L08U78 + ZCE10 1,8 4,2(P) 0,8 5mm</p>	<p>ZCMD21L08U78 + ZCE11 1,8 4,2(P) 0,8 5mm</p>	<p>ZCMD21L08U78 + ZCE02 3,1(A) 7(P) 1,4 mm</p>	<p>ZCMD21L08U78 + ZCE24 11,2(A) 25(P) 0 4,9 mm</p>	<p>ZCMD21L08U78 + ZCEF0 1,8 4,2(P) 0,8 5mm</p>	<p>ZCMD21L08U78 + ZCEG1 1,8 4,2(P) 0,8 5mm</p>	<p>ZCMD21L08U78 + ZCEF2 3,1(A) 7(P) 1,4 mm</p>
<p>Weight, kg (lb)</p>	0.150 (0.331)	0.150 (0.331)	0.155 (0.342)	0.170 (0.375)	0.165 (0.364)	0.190 (0.419)	0.175 (0.386)

contact closed      (A) = cam displacement      ⊕ N/C contact with positive opening operation, when properly mounted and using a conforming operator  
 contact open      (P) = positive opening point

#### Characteristics

Switch actuation	On end	By 30° cam	By 30° cam	On end	By 30° cam
Type of actuation					
Maximum actuation speed	0.5 m/s (1.64 ft/s)			0.1 m/s (0.33 ft/s)	
Minimum force or torque	For tripping	8.5 N (1.91 lb)	7 N (1.57 lb)	2.5 N (0.56 lb)	8.5 N (1.91 lb)
	For positive opening	42.5 N (9.55 lb)	35 N (7.87 lb)	12.5 N (2.81 lb)	42.5 N (9.55 lb)
Positive operation	Although their design is identical to the pre-cabled switches, the switches incorporating an M12 4-pin connector cannot be marked with the ⊕ symbol because they are single-pole C/O.				

NOTE: For more information, consult pages 38–40.



# Limit Switches

## Osiswitch® Miniature, Metal

### Universal, XCMD, Integral or Remote Connector

Type of head	Rotary (mounting by the body)				Multi-directional
Type of operator	Thermoplastic roller lever	Steel roller lever	Roller lever with ball bearing mounted roller	Variable length thermoplastic roller lever	Cat's whisker (1)
<b>Catalog numbers</b>					
 Single-pole C/O snap action With integral M12 4-pin connector	XCMD2115M12 	XCMD2116M12 	XCMD2117M12 	XCMD2145M12 	XCMD2106M12 
 2-pole N/C + N/O snap action With integral M12 5-pin connector	XCMD2115C12 	XCMD2116C12 	XCM D2117C12 	XCMD2145C12 	XCMD2106C12 
 2-pole N/C + N/C snap action With integral M12 5-pin connector	ZCMD29C12 + ZCE01 + ZCY15 	ZCMD29C12 + ZCE01 + ZCY16 	ZCMD29C12 + ZCE01 + ZCY17 	ZCMD29C12 + ZCE01 + ZCY45 	ZCMD29C12 + ZCE06 
Weight, kg (lb)	0.125 (0.276)	0.130 (0.287)	0.125 (0.276)	0.135 (0.298)	0.085 (0.187)
 2-pole N/C + N/O snap action With M12 5-pin connector on 0.8 m (2.6 ft) flying lead	ZCMD21L08R12 + ZCE01 + ZCY15 	ZCMD21L08R12 + ZCE01 + ZCY16 	ZCMD21L08R12 + ZCE01 + ZCY17 	ZCMD21L08R12 + ZCE01 + ZCY45 	ZCMD21L08R12 + ZCE06 
 2-pole N/C + N/O snap action With 7/8" 16UN 5-pin connector on 0.8 m (2.6 ft) flying lead	ZCMD21L08U78 + ZCE01 + ZCY15 	ZCMD21L08U78 + ZCE01 + ZCY16 	ZCMD21L08U78 + ZCE01 + ZCY17 	ZCMD21L08U78 + ZCE01 + ZCY45 	ZCMD21L08U78 + ZCE06 
Weight, kg (lb)	0.200 (0.441)	0.205 (0.452)	0.200 (0.441)	0.210 (0.463)	0.160 (0.353)
Contact operation	(A) = cam displacement (P) = positive opening point ⊕ N/C contact with positive opening operation, when properly mounted and using a conforming operator				
1. Value taken with actuation by moving part at 100 mm (3.94 in.) from the mounting.					
<b>Characteristics</b>					
Switch actuation	By 30° cam				By any moving part
Type of actuation					
Maximum actuation speed	1.5 m/s (4.92 ft/s)				1 m/s (3.28 ft/s)
Minimum force or torque	For tripping	0.1 N•m (0.89 lb-in)			
	For positive opening	0.5 N•m (4.43 lb-in)			
Positive operation	Although their design is identical to the pre-cabled switches, the switches incorporating an M12 4-pin connector cannot be marked with the ⊕ symbol because they are single-pole C/O.				

# Limit Switches

## Osiswitch® Miniature, Metal

### Universal, XCMD—Modular

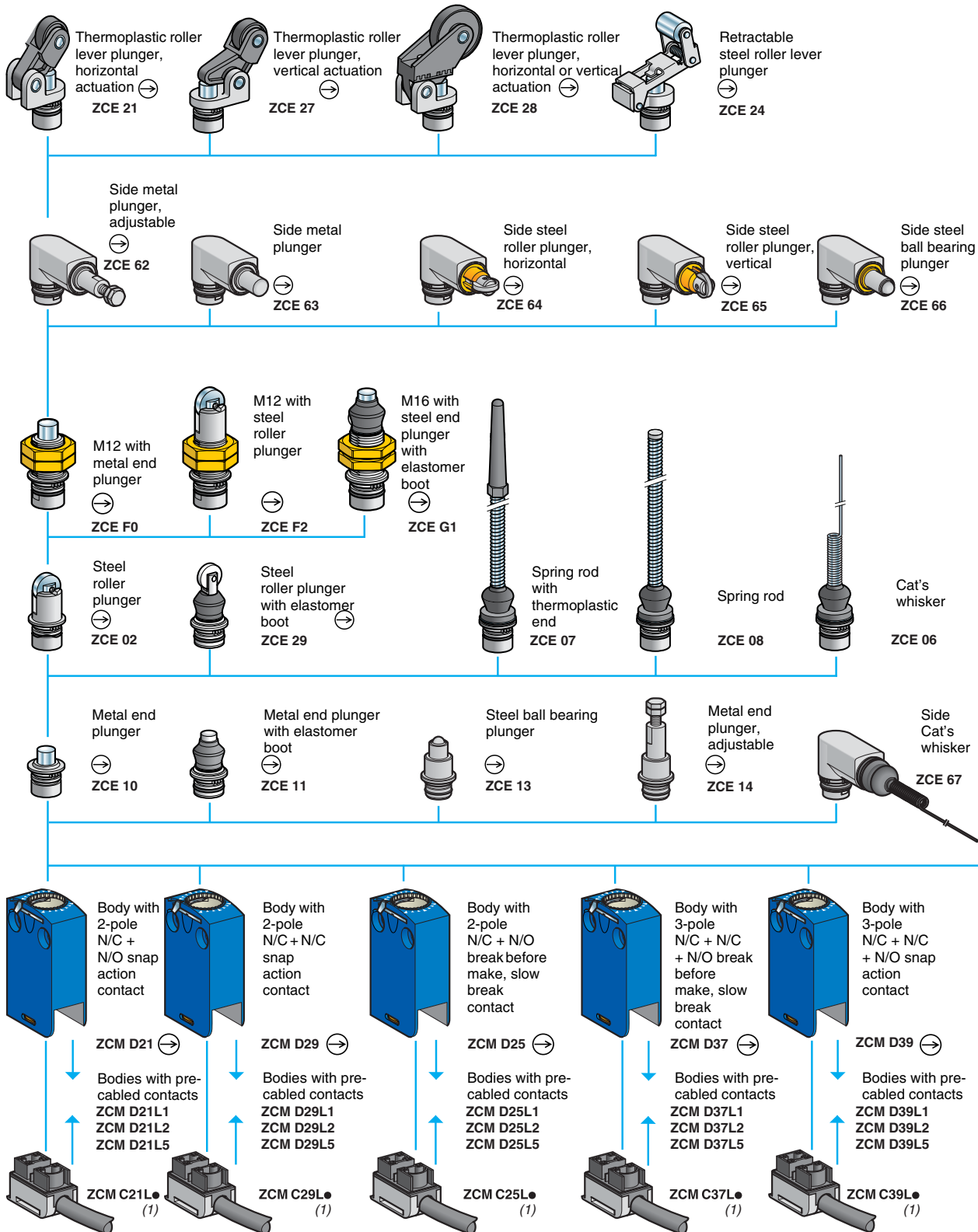

1. Pre-cabled connection components: replace the "\*" in the catalog number with the required cable length in meters, either: 1, 2, 3, 5, 7 or 10. Example: ZCM C21L\* becomes ZCM C21L7 for a 7 m (23.0 ft) cable. Note: only cable lengths of 1, 2 and 5 m (3.3, 6.6, and 16.4 ft) are available for pre-cabled connection components ZCM C37L\* and ZCM C39L\*.

# Limit Switches

## Osiswitch® Miniature, Metal

### Universal, XCMD—Modular

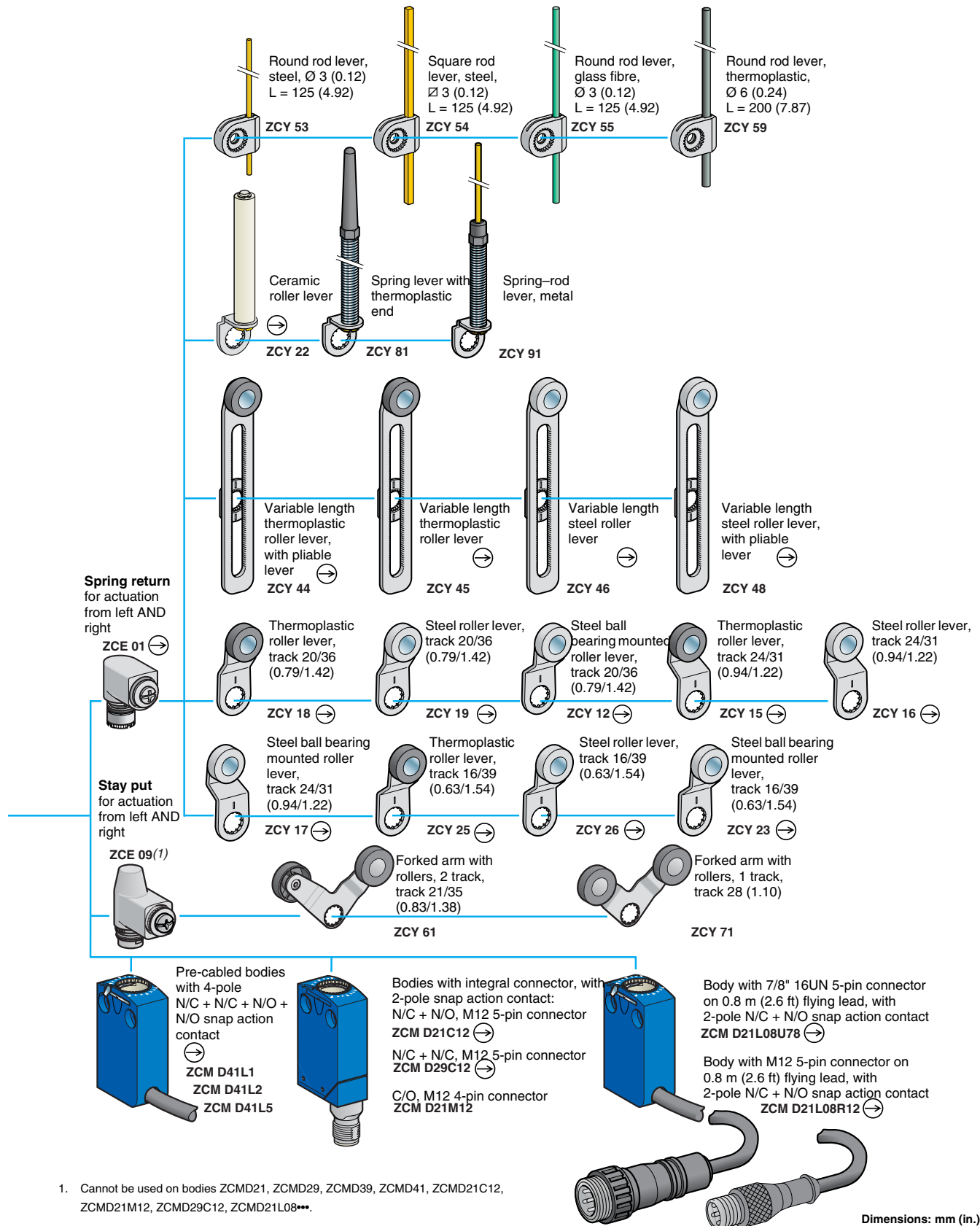

1. Cannot be used on bodies ZCMD21, ZCMD29, ZCMD39, ZCMD41, ZCMD21C12, ZCMD21M12, ZCMD29C12, ZCMD21L08\*\*\*.

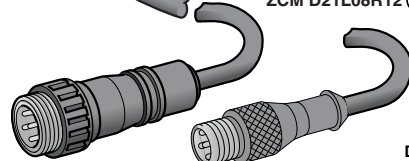

Dimensions: mm (in.)

# Limit Switches

## Osiswitch® Miniature, Metal

### Universal, XCMD—Modular

#### Special Features and Catalog Number Explanation

#### Interpretation of the Catalog Number

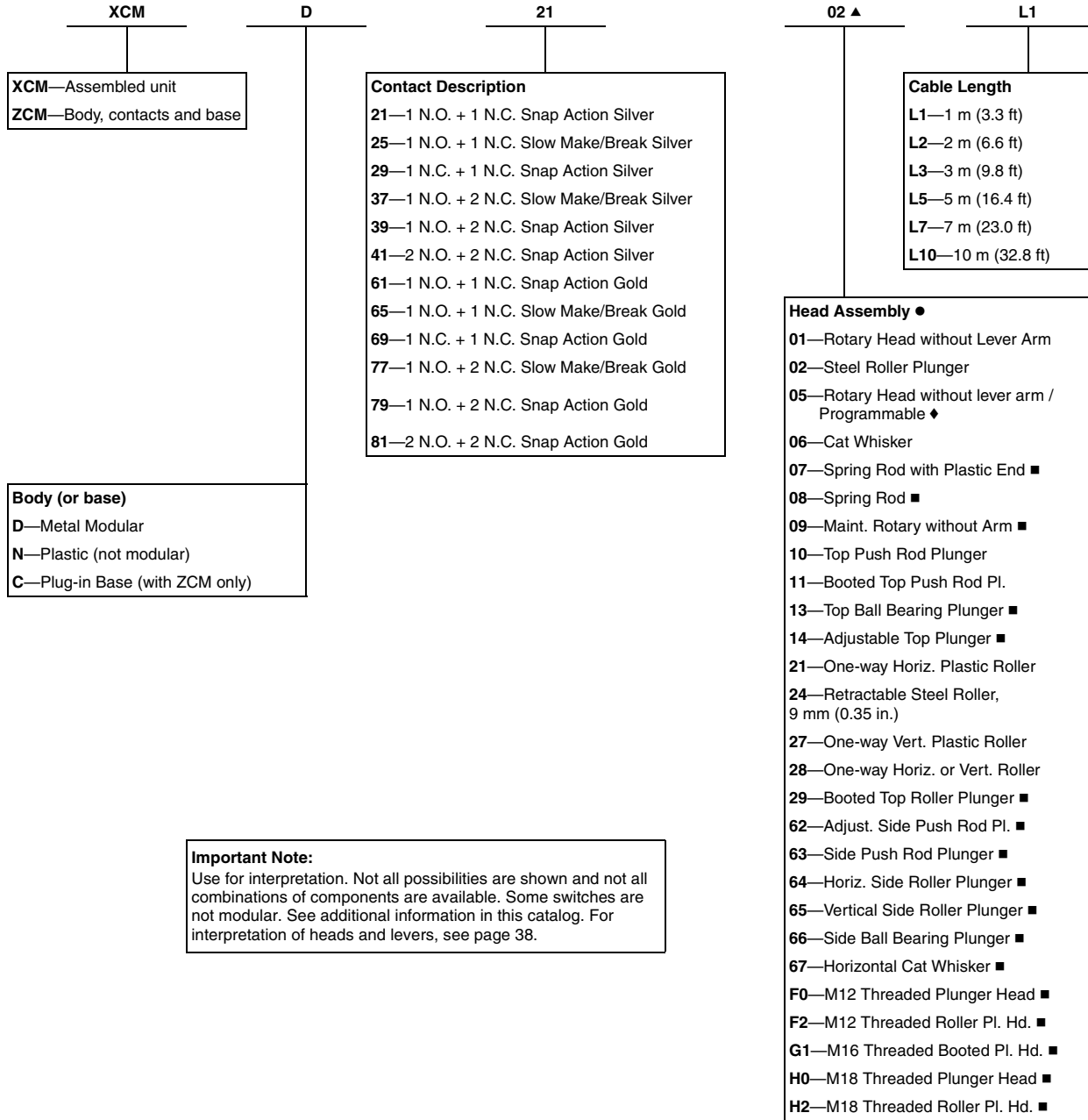

- Consult your local field sales office for availability.
- ▲ Last two digits of lever catalog number occupy this position when rotary heads with levers are required.
- See page 38 for levers.
- ◆ See page 43 for available levers, specifically allowed for the ZCE05 programmable head.

**Limit Switches**  
**Osiswitch® Miniature, Metal**  
**Universal, XCMD—Modular**

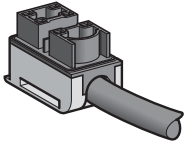

ZCMC29L0

**Components**

Plug-in base with PVR cable ♦				
Contact type	Diagram	Length of PVR cable m (ft)	Catalog number ■	Weight lb (kg)
<b>2-pole</b>				
2-pole N.C. + N.O. snap action		1 (3.3)	ZCMC21L1	0.22 (0.100)
2-pole N.C. + N.O. snap action		2 (6.6)	ZCMC21L2	0.42 (0.190)
2-pole N.C. + N.O. snap action		3 (9.8)	ZCMC21L3	0.62 (0.280)
2-pole N.C. + N.O. snap action		5 (16.4)	ZCMC21L5	1.00 (0.440)
2-pole N.C. + N.O. snap action		7 (23.0)	ZCMC21L7	1.50 (0.700)
2-pole N.C. + N.O. snap action		10 (32.8)	ZCMC21L10	2.10 (0.970)
2-pole N.C. + N.O. slow break-before-make		1 (3.3)	ZCMC25L1	0.22 (0.100)
2-pole N.C. + N.O. slow break-before-make		2 (6.6)	ZCMC25L2	0.42 (0.190)
2-pole N.C. + N.O. slow break-before-make		3 (9.8)	ZCMC25L3	0.62 (0.280)
2-pole N.C. + N.O. slow break-before-make		5 (16.4)	ZCMC25L5	1.00 (0.440)
2-pole N.C. + N.O. slow break-before-make		7 (23.0)	ZCMC25L7	1.50 (0.700)
2-pole N.C. + N.O. slow break-before-make		10 (32.8)	ZCMC25L10	2.10 (0.970)

♦ The plug-in base receptacle must match the contact pin outs in the body. Only the length of cord is variable. See page 38 for 3-pole plug-in bases with cord. The 4-pole units and connector versions do not have component modular bases. See pages 32 and 33 for 4 contact bodies, and pages 36 and 37 for M12 connector bodies.

- Available cable lengths:  
 ZCMC29L•: 1, 2, 3, 5, 7, and 10 m (3.3, 6.6, 9.8, 16.4, 23.0, and 32.8 ft)  
 ZCMC37L•: 1, 2, and 5 m (3.3, 6.6, and 16.4 ft)  
 ZCMC39L•: 1, 2, and 5 m (3.3, 6.6, and 16.4 ft)

# Limit Switches

## Osiswitch® Miniature, Metal

### Universal, XCMD—Modular

### Components

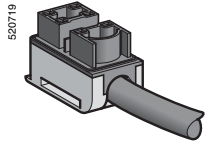

ZCMC21E•

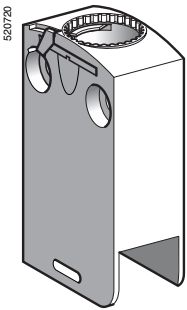

ZCMD6•  
ZCMD7•

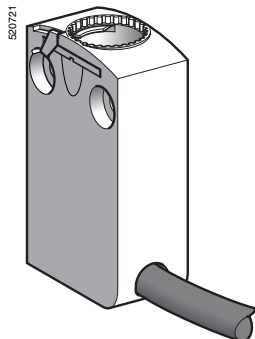

ZCMD81L•

#### Pre-cabled connection components (CEI cable) (1)

Type of contact	Wiring diagram	Length of CEI cable, m (ft)	Catalog Number	Weight kg (lb)
<b>2-pole</b>				
N/C + N/O snap action		1 (3.28)	ZCMC21E1	0.100 (0.220)
		2 (6.56)	ZCMC21E2	0.190 (0.419)
		3 (9.84)	ZCMC21E3	0.280 (0.617)
		5 (16.40)	ZCMC21E5	0.440 (0.970)
		7 (22.97)	ZCMC21E7	0.700 (1.543)
		10 (32.81)	ZCMC21E10	0.970 (2.138)

#### Bodies with gold contacts

Type of contact	Positive operation (2)	Wiring diagram	Length of cable, m (ft)	Catalog Number	Weight kg (lb)
<b>2-pole</b>					
N/C + N/O snap action	⊕		—	ZCMD61	0.055 (0.121)
N/C + N/C snap action	⊕		—	ZCMD69	0.055 (0.121)
N/C + N/O break before make, slow break	⊕		—	ZCMD65	0.055 (0.121)
<b>3-pole</b>					
N/C + N/C + N/O snap action	⊕		—	ZCMD79	0.055 (0.121)
N/C + N/C + N/O break before make, slow break	⊕		—	ZCMD77	0.055 (0.121)
<b>4-pole</b>					
N/C + N/C + N/O + N/O snap action	⊕		1 (3.28)	ZCMD81L1	0.160 (0.353)
			2 (6.56)	ZCMD81L2	0.255 (0.562)
			5 (16.40)	ZCMD81L5	0.525 (1.157)

1. Cable not UL, CSA certified.
2. ⊕ bodies with contacts assuring positive opening operation, when properly mounted and using a conforming operator.

# Limit Switches

## Osiswitch® Miniature, Metal

### Universal, XCMD

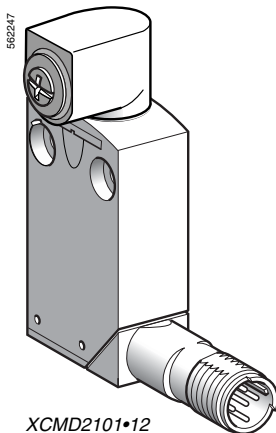
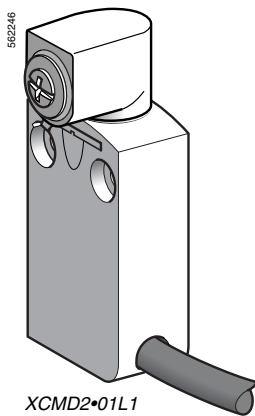
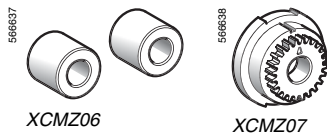
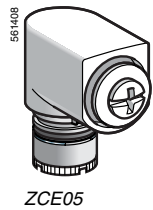
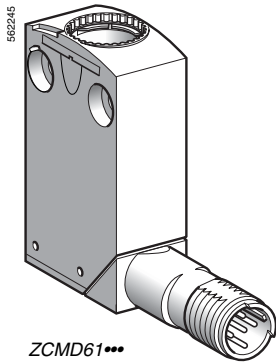

#### Bodies with gold contacts, integral connector

Type of contact	Positive operation (1)	Wiring diagram	Connector	Catalog Number	Weight kg (lb)
<b>2-pole</b>					
N/C + N/O snap action	—		M12 5-pin	ZCMD61C12	0.065 (0.143)
N/C + N/C snap action	—		M12 5-pin	ZCMD69C12	0.065 (0.143)
<b>Single-pole</b>					
C/O snap action	—		M12 4-pin	ZCMD61M12	0.065 (0.143)

#### Accessories

Description	Positive operation (1)	Suitable levers for use with head	Catalog Number	Weight kg (lb)
Rotary head, without lever, spring return, for actuation from left AND right or from left OR right (2)	⊕	ZCY12, ZCY15, ZCY16, ZCY17, ZCY18, ZCY19, ZCY22, ZCY23, ZCY25, ZCY26, ZCY39, ZCY53, ZCY54, ZCY55, ZCY81	ZCE05	0.045 (0.099)
Spacer for mounting multi-track XCMD	—	—	XCMZ06	0.005 (0.011)
Spacer for angular positioning of heads with adjustable levers, for values other than -90°, 0° and 90°	—	—	XCMZ07	0.005 (0.011)

#### Bodies with contacts, with rotary head (without operating lever), pre-cabled

Type of contact	Positive operation (1)	Wiring diagram	Length of cable, m (ft)	Catalog Number	Weight kg (lb)
<b>2-pole</b>					
N/C + N/O snap action	⊕		1 (3.28)	XCMD2101L1	0.180 (0.397)
N/C + N/O break before make, slow break	⊕		1 (3.28)	XCMD2501L1	0.180 (0.397)

#### Bodies with contacts, with rotary head (without operating lever), integral connector

Type of contact	Positive operation (1)	Wiring diagram	Connector	Catalog Number	Weight kg (lb)
<b>2-pole</b>					
N/C + N/O snap action	⊕		M12 5-pin	XCMD2101C12	0.110 (0.243)
<b>Single-pole</b>					
C/O snap action	—		M12 4-pin	XCMD2101M12	0.110 (0.243)

- ⊕ bodies with contacts or head assuring positive opening operation, when properly mounted and using a conforming operator.
- For programming see page 12.

# Limit Switches

## Osiswitch® Miniature, Metal

### Universal, XCMD—Connector Cabling Accessories

#### Catalog Numbers of suitable pre-wired female connectors

Type of connector	M12 straight, 4-pin 4 A, 250 V	M12 straight, 5-pin 4 A, 24 V	M12 elbowed, 5-pin 4 A, 24 V	7/8" 16 UN straight, 5-pin, 6 A, 250 V
With cable	L = 2 m (6.56 ft)	XZCP1169L2	XZCP1164L2	XZCP1264L2
	L = 5 m (16.40 ft)	XZCP1169L5	XZCP1164L5	XZCP1264L5
	L = 10 m (32.81 ft)	XZCP1169L10	XZCP1164L10	XZCP1264L10
Weight, kg (lb)	0.105 (0.231)	0.115 (0.254)	0.115 (0.254)	0.190 (0.419)

#### Connections

##### XCMD with connector

###### 4-pin, M12

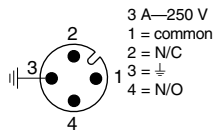

###### 5-pin, M12

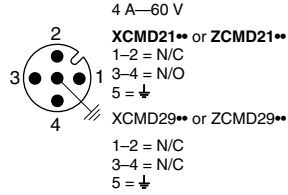

###### 5-pin, 7/8" 16 UN

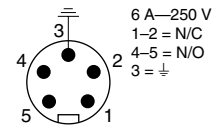

#### Pre-wired female connectors XZCP

###### 4-pin, M12

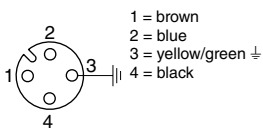

###### 5-pin, M12

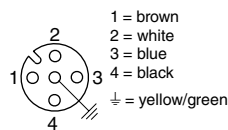

###### 5-pin, 7/8" 16 UN

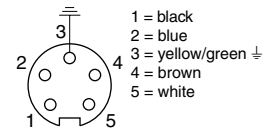

#### Dimensions

##### XZCP116•L•

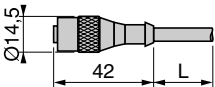

##### XZCP1264L•

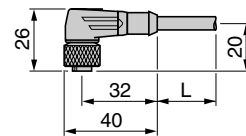

##### XZCP1771L•

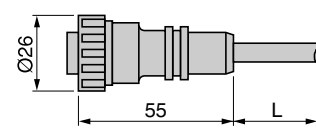

L: cable length 2, 5, or 10 m (6.6, 16.4, or 32.8 ft)

#### Distances required for plug-in connectors

##### M12 straight connector

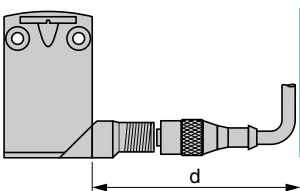

d: min. 65 mm (2.56 in.),  
recommended 69 mm (2.72 in.)

##### M12 elbowed connector

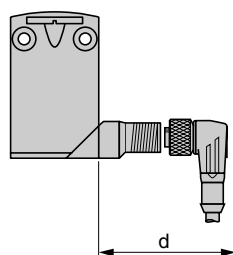

d: min. 42 mm (1.65 in.),  
recommended 45 mm (1.77 in.)

##### Connector on flying lead

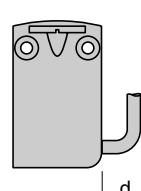

d: min. 20 mm (0.79 in.)



# Limit Switches

## Osiswitch® Miniature, Metal

### Universal, XCMD, Integral or Remote Connector

XCMD2•10M12

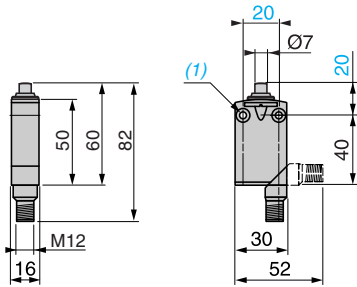

XCMD2•11M12

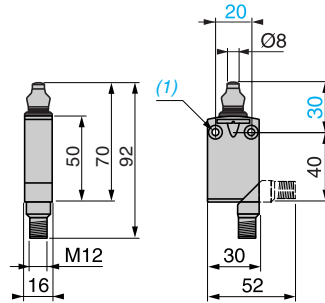

XCMD2•02M12

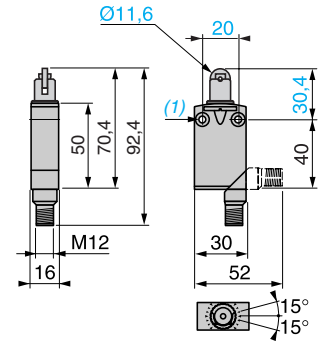

XCMD2•24M12

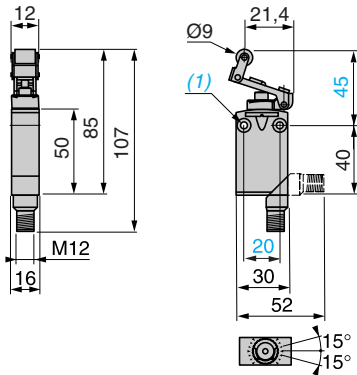

XCMD2•F0M12

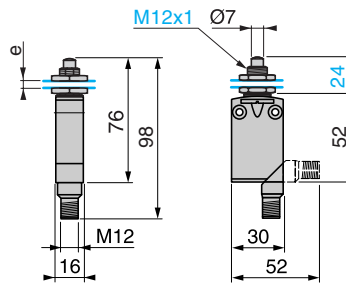

XCMD2•G1M12

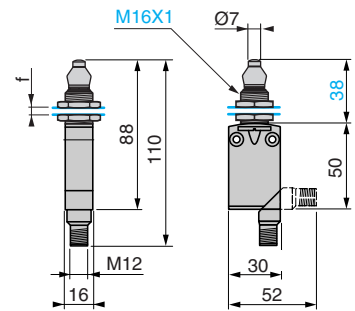

XCMD2•F2M12

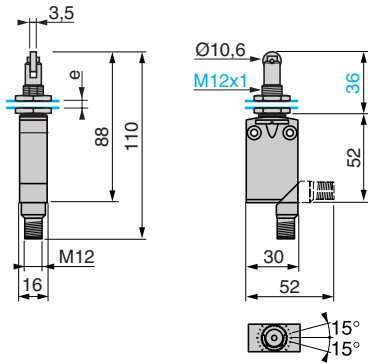

XCMD2•45M12

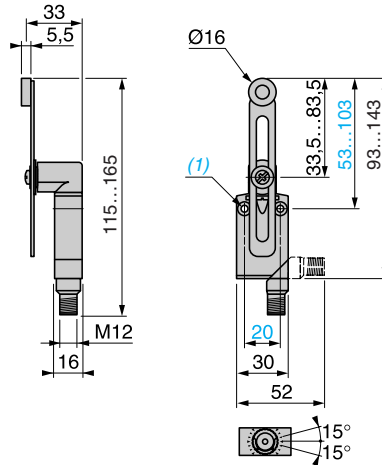

XCMD2•15M12 / 16M12 / 17M12

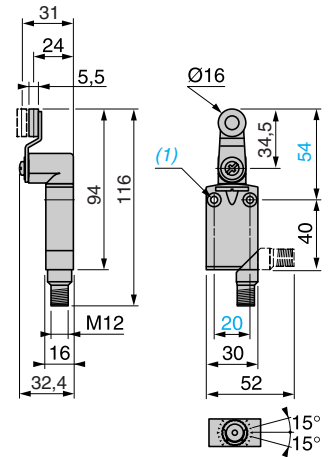

XCMD2•06M12

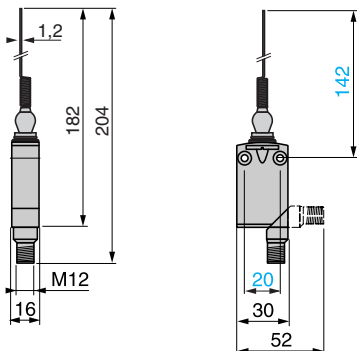

- 1. 2 mounting holes Ø 4.2 mm (0.17 in.), counterbored Ø 8 mm (0.31 in.) by 4 mm (0.16 in.) deep.
- e: 8 mm (0.31 in.) max., panel cut-out Ø 12.5 mm (0.49 in.), mounting nut thickness 3.5 mm (0.14 in.).
- f: 8 mm (0.31 in.) max., panel cut-out Ø 16.5 mm (0.65 in.), mounting nut thickness 3.5 mm (0.14 in.).

# Limit Switches

## Osiswitch® Miniature, Metal

### Universal, XCMD, Integral or Remote Connector

ZCMD21L08\*\*\* + ZCE 10

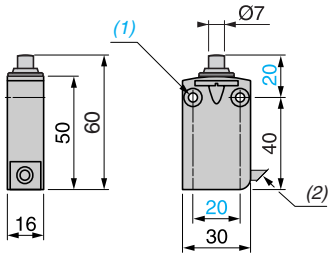

ZCMD21L08\*\*\* + ZCE 11

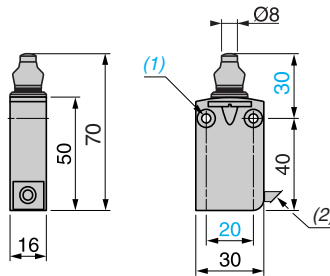

ZCMD21L08\*\*\* + ZCE 02

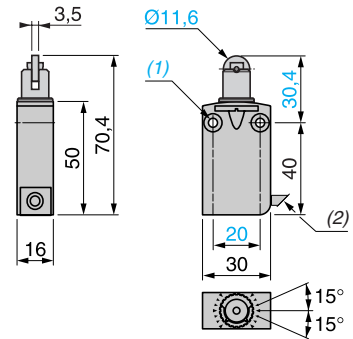

ZCMD21L08\*\*\* + ZCE 24

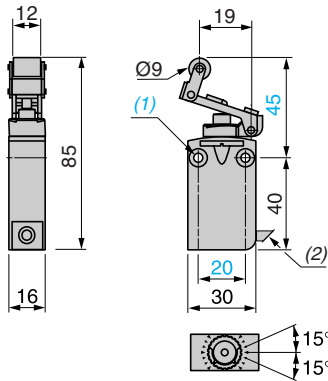

ZCMD21L08\*\*\* + ZCE F0

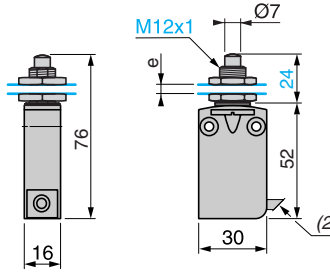

ZCMD21L08\*\*\* + ZCE G1

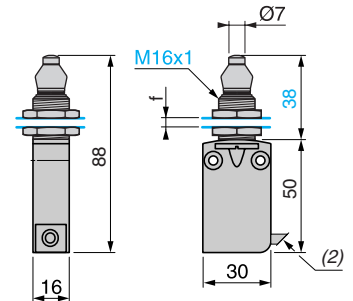

1. 2 mounting holes  $\text{Ø} 4.2 \text{ mm}$  (0.17 in.), counterbored  $\text{Ø} 8 \text{ mm}$  (0.31 in.) by 4 mm (0.16 in.) deep.
2. Overall diameter 7.5 mm (0.30 in.).
- e: 8 mm (0.31 in.) max., panel cut-out  $\text{Ø} 12.5 \text{ mm}$  (0.49 in.), mounting nut thickness 3.5 mm (0.14 in.).
- f: 8 mm (0.31 in.) max., panel cut-out  $\text{Ø} 16.5 \text{ mm}$  (0.65 in.), mounting nut thickness 3.5 mm (0.14 in.).

# Limit Switches

## Osiswitch® Miniature, Metal

### Universal, XCMD, Integral or Remote Connector

ZCMD21L08\*\*\* + ZCEF2

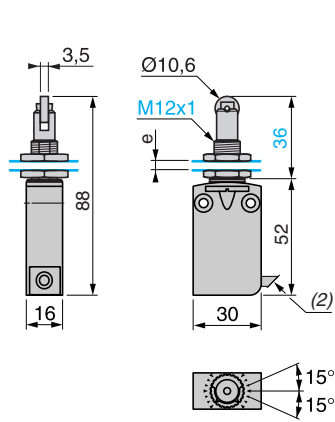

ZCMD21L08\*\*\* + ZCE01 + ZCY 15/16/17

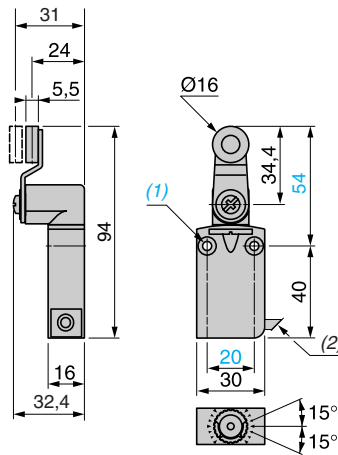

ZCMD21L08\*\*\* + ZCE01 + ZCY 45

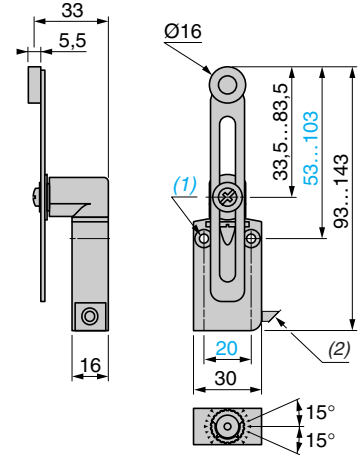

ZCMD21L08\*\*\* + ZCE06

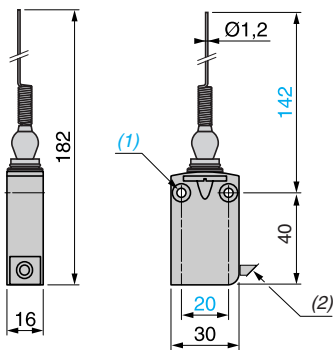

1. 2 mounting holes  $\varnothing 4.2$  mm (0.17 in.), counterbored  $\varnothing 8$  mm (0.31 in.) by 4 mm (0.16 in.) deep.
2. Overall diameter 7.5 mm (0.30 in.).
- e: 8 mm (0.31 in.) max., panel cut-out  $\varnothing 12.5$  mm (0.49 in.), mounting nut thickness 3.5 mm (0.14 in.).
- f: 8 mm (0.31 in.) max., panel cut-out  $\varnothing 16.5$  mm (0.65 in.), mounting nut thickness 3.5 mm (0.14 in.).

# Limit Switches

## Osiswitch® Miniature, Plastic

### XCMN

■ XCMN  
pre-cabled

□ With head for linear movement (plunger). Mounting by the body.

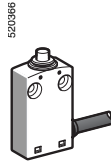

Page 50

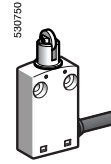

□ With head for linear movement (plunger). Mounting by the head.

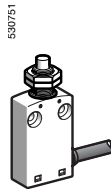

Page 50

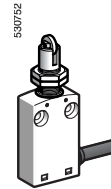

□ With head for rotary movement (lever) or multi-directional.

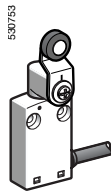

Page 51

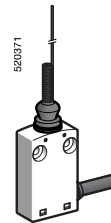

# Limit Switches

## Osiswitch® Miniature, Plastic

### XCMN

Environment characteristics		
Conforming to standards	Products	IEC 60947-5-1, EN 60947-5-1, UL 508, CSA C22-2 n° 14
	Machine assemblies	IEC 60204-1, EN 60204-1
Product certifications		UL, CSA, CCC
Protective treatment	Standard version	"TC"
Ambient air temperature	Operation	- 25...+70 °C (-13...+158 °F)
	Storage	- 40...+70 °C (-40...+158 °F)
Vibration resistance	Conforming to IEC 60068-2-6	5 gn (10...500 Hz)
Shock resistance	Conforming to IEC 60068-2-27	25 gn (18 ms)
Electric shock protection		Class II conforming to IEC 61140 and NF C 20030
Degree of protection		IP 65 conforming to IEC 60529; IK 04 conforming to EN 50102
Materials	Bodies	Plastic
	Heads	Zamak® zinc alloy
Contact block characteristics		
Rated operational characteristics		~ AC-15; B300 (U <sub>e</sub> = 240 V, I <sub>e</sub> = 1.5 A); I <sub>the</sub> = 6 A
		≡ DC-13; R300 (U <sub>e</sub> = 250 V, I <sub>e</sub> = 0.1 A), conforming to IEC 60947-5-1 Appendix A, EN 60947-5-1
Rated insulation voltage		U <sub>i</sub> = 400 V degree of pollution 3 conforming to IEC 60947-1 U <sub>i</sub> = 300 V conforming to UL 508, CSA C22-2 n° 14
Rated impulse withstand voltage		U <sub>imp</sub> = 4 kV conforming to IEC 60947-1, IEC 60664
Short-circuit protection		6 A cartridge fuse type gG (gI)

# Limit Switches

## Osiswitch® Miniature, Plastic

### XCMN, Pre-Cabled

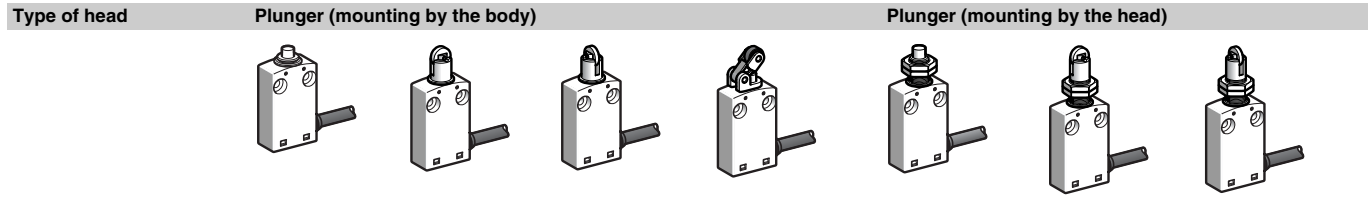

Type of operator	Metal end plunger	Steel roller plunger for lateral cam approach	Steel roller plunger for traverse cam approach	Thermoplastic roller lever plunger, 1 direction of actuation	M12 with metal end plunger	M12 with steel roller plunger for lateral cam approach	M12 with steel roller plunger for traverse cam approach
------------------	-------------------	---	--	--	----------------------------	--	---

Catalog Numbers		XCMN2110L1	XCMN2102L1	XCMN2103L1	XCMN2121L1	XCMN21F0L1	XCMN21F2L1	XCMN21F3L1
<p>2-pole N/C + N/O snap action</p>								
Weight, kg (lb)	0.080 (0.176)	0.080 (0.176)	0.080 (0.176)	0.090 (0.198)	0.065 (0.143)	0.095 (0.209)	0.095 (0.209)	
Contact operation			(A) = cam displacement (P) = positive opening point					

Characteristics		Plunger (mounting by the body)			Plunger (mounting by the head)	
Switch actuation	On end	By 30° cam		On end	By 30° cam	
Type of actuation						
Maximum actuation speed	0.5 m/s (1.64 ft/s)	0.1 m/s (0.33 ft/s)		0.5 m/s (1.64 ft/s)	0.1 m/s (0.33 ft/s)	
Minimum force or torque	For tripping	8.5 N (1.91 lb)	7 N (1.57 lb)	2.5 N (0.56 lb)	8.5 N (1.91 lb)	7 N (1.57 lb)
	For positive opening	42.5 N (9.55 lb)	35 N (7.87 lb)	12.5 N (2.81 lb)	42.5 N (9.55 lb)	35 N (7.87 lb)
Cabling	PvR cable, 4 x 0.75 mm <sup>2</sup> , length 1 m (3.28 ft)					

### Dimensions

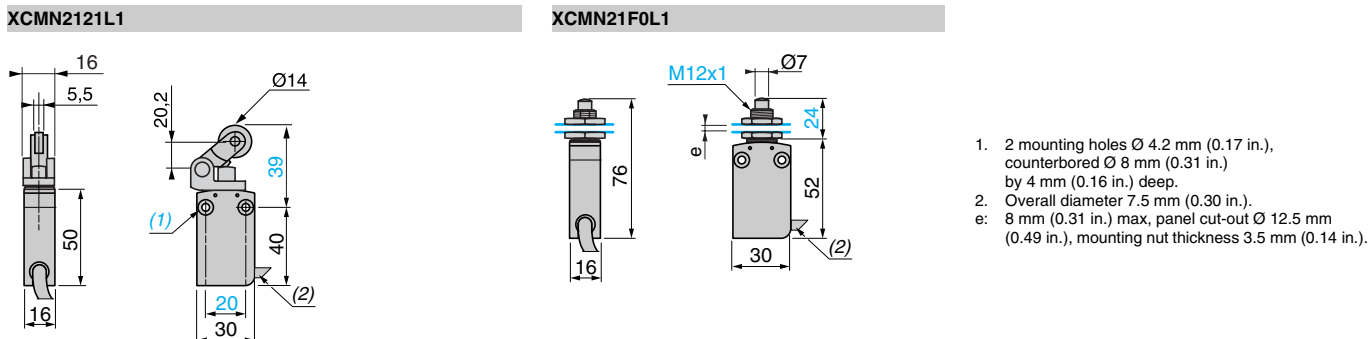
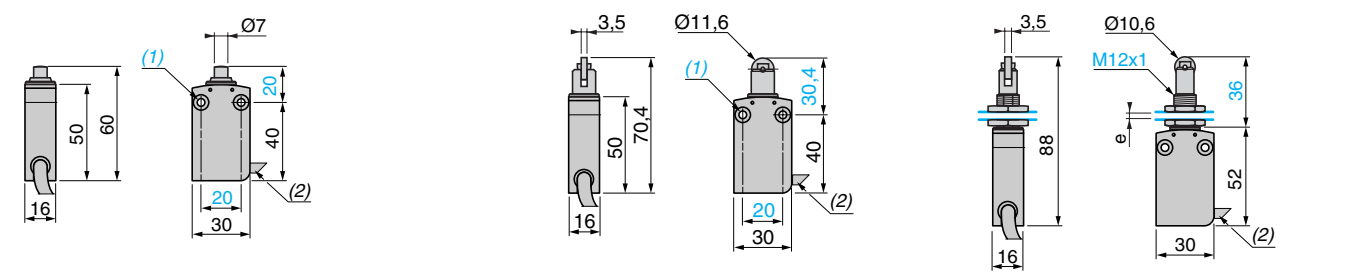

- 2 mounting holes  $\varnothing$  4.2 mm (0.17 in.), counterbored  $\varnothing$  8 mm (0.31 in.) by 4 mm (0.16 in.) deep.
- Overall diameter 7.5 mm (0.30 in.).
- 8 mm (0.31 in.) max. panel cut-out  $\varnothing$  12.5 mm (0.49 in.), mounting nut thickness 3.5 mm (0.14 in.).

# Limit Switches

## Osiswitch® Miniature, Plastic

### XCMN, Pre-Cabled

Type of head	Rotary (mounting by the body)			Multi-directional	
Type of operator	Thermoplastic roller lever	Variable length thermoplastic roller lever	Round thermoplastic rod lever Ø 6 mm (0.24 in.) (1)	Spring lever with thermoplastic end (1)	Cat's whisker (1)
Catalog Numbers	<b>XCMN2115L1</b> 	<b>XCMN2145L1</b> 	<b>XCMN2159L1</b> 	<b>XCMN2107L1</b> 	<b>XCMN2106L1</b> 
Weight, kg (lb)	0.100 (0.220)	0.105 (0.231)	0.080 (0.176)	0.085 (0.187)	0.080 (0.176)
Contact operation	(A) = cam displacement (P) = positive opening point ⊕ N/C contact with positive opening operation, when properly mounted and using a conforming operator				
Characteristics	1. Value taken with actuation by moving part at 100 mm (3.94 in.) from the mountings.				
Switch actuation	By 30° cam		By any moving part		
Type of actuation					
Maximum actuation speed	1.5 m/s (4.92 ft/s)		1 m/s (3.28 ft/s)		
Minimum force or torque	For tripping: 0.1 N•m (0.89 lb-in) For positive opening: 0.5 N•m (4.43 lb-in)		—		
Cabling	PvR cable, 4 x 0.75 mm <sup>2</sup> , length 1 m (3.28 ft)				

### Dimensions

XCMN2115L1	XCMN2159L1	XCMN2107L1
XCMN2145L1	XCMN2106L1	

1. 2 mounting holes Ø 4.2 mm (0.17 in.), counterbored Ø 8 mm (0.31 in.) by 4 mm (0.16 in.) deep.  
 2. Overall diameter 7.5 mm (0.30 in.).

Limit Switches

# Limit Switches

## Osiswitch® Compact

### Universal, XCKP and XCKT Plastic / XCKD Metal

■ **XCKP, XCKD**  
with 1 cable entry  
Conforming to CENELEC EN 50047

□ With head for linear movement (plunger). Mounting by the head or by the body.  
**XCK D** **XCK P**

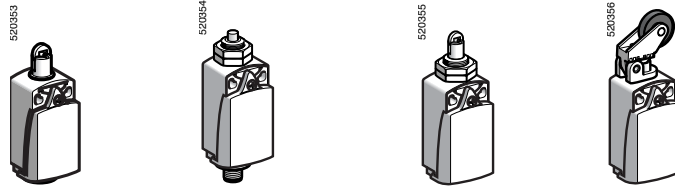

Pages 54 and 58

Pages 60 and 64

□ With head for rotary movement (lever) or multi-directional. Mounting by the body.  
**XCK D** **XCK P**

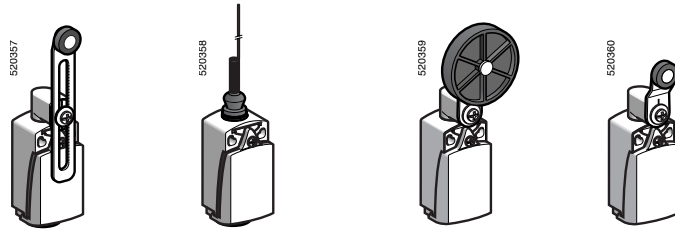

Pages 55 and 59

Pages 61 and 65

■ **XCKT**  
with 2 cable entries  
Tripping/resetting points and mounting centers conform to CENELEC EN 50047

□ With head for linear movement (plunger). Mounting by the head or by the body.  
**XCK T**

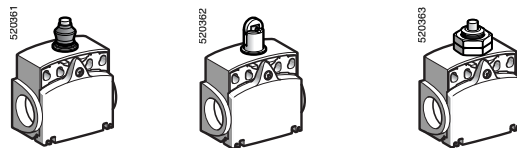

Page 66

□ With head for rotary movement (lever) or multi-directional. Mounting by the body.  
**XCK T**

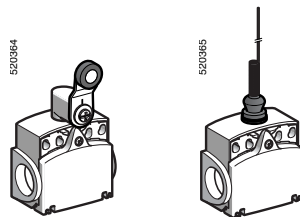

Page 66

### Environment characteristics

<b>Conforming to standards</b>	Products	IEC 60947-5-1, EN 60947-5-1, UL 508, CSA C22-2 n° 14
	Machine assemblies	IEC 60204-1, EN 60204-1
<b>Product certifications</b>		UL, CSA, CCC
<b>Protective treatment</b>	Standard version	"TC"
<b>Ambient air temperature</b>	Operation	- 25...+70 °C (-13...+158 °F)
	Storage	- 40...+70 °C (-40...+158 °F)
<b>Vibration resistance</b>	Conforming to IEC 60068-2-6	25 gn (10...500 Hz) except switch with head ZCE 24: 20 gn
<b>Shock resistance</b>	Conforming to IEC 60068-2-27	50 gn (11 ms) except heads ZCE08: 15 gn (11 ms) and ZCE24: 30 gn (18 ms)
<b>Electric shock protection</b>		Class II conforming to IEC 61140 and NF C 20-030 for <b>XCKP</b> and <b>XCKT</b> Class I conforming to IEC 61140 and NF C 20-030 for <b>XCKD</b>
<b>Degree of protection</b>		IP 66 and IP 67 conforming to IEC 60529; IK 04 conforming to EN 50102 for XCKP and XCKT, IK 06 conforming to EN 50102 for XCKD
<b>Repeat accuracy</b>		0.1 mm on the tripping points, with 1 million operating cycles for head with end plunger
<b>Cable entry or integral connector</b>	Depending on model	Either: tapped entry for PG 11 or PG 13 conduit thread, tapped ISO M16 x 1.5 or ISO M20 x 1.5, tapped 1/2" NPT, tapped PF 1/2 (G1/2) or integral M12 connector
<b>Materials</b>		<b>XCKD</b> : Zamak® bodies and heads, <b>XCKP</b> and <b>XCKT</b> : plastic bodies, Zamak heads



# Limit Switches

## Osiswitch® Compact

### Universal, XCKP and XCKT Plastic / XCKD Metal

#### Contact block characteristics

Rated operational characteristics	XE2•P	$\sim$ AC-15; A300 ( $U_e = 240$ V, $I_e = 3$ A); $I_{the} = 10$ A $\equiv$ DC-13; Q300 ( $U_e = 250$ V, $I_e = 0.27$ A), conforming to IEC 60947-5-1 Appendix A, EN 60947-5-1
	XE3•P	$\sim$ AC-15; B300 ( $U_e = 240$ V, $I_e = 1.5$ A); $I_{the} = 6$ A $\equiv$ DC-13; R300 ( $U_e = 250$ V, $I_e = 0.1$ A), conforming to IEC 60947-5-1 Appendix A, EN 60947-5-1
Rated insulation voltage	XE2•P	$U_i = 500$ V degree of pollution 3 conforming to IEC 60947-1 $U_i = 300$ V conforming to UL 508, CSA C22-2 n° 14
	XE3•P	$U_i = 400$ V degree of pollution 3 conforming to IEC 60947-1 $U_i = 300$ V conforming to UL 508, CSA C22-2 n° 14
Rated impulse withstand voltage	XE2•P	$U_{imp} = 6$ kV conforming to IEC 60947-1, IEC 60664
	XE3•P	$U_{imp} = 4$ kV conforming to IEC 60947-1, IEC 60664
Positive operation (depending on model)	N/C contacts with positive opening operation conforming to IEC 60 947-5-1 Appendix K, EN 60947-5-1	
Resistance across terminals	$\leq 25$ m $\Omega$ conforming to IEC 60255-7 category 3	
Short-circuit protection	XE2•P	10 A cartridge fuse type gG (gl)
	XE3•P	6 A cartridge fuse type gG (gl)
Cabling (screw clamp terminals)	XE2SP•151 and XE2SP2141	Clamping capacity, min: 1 x 0.34 mm <sup>2</sup> , max: 2 x 1.5 mm <sup>2</sup>
	XE2NP21•1 and XE2NP31•1	Clamping capacity, min: 1 x 0.5 mm <sup>2</sup> , max: 2 x 2.5 mm <sup>2</sup>
	XE3NP and XE3SP	Clamping capacity, min: 1 x 0.34 mm <sup>2</sup> , max: 1 x 1 mm <sup>2</sup> or 2 x 0.75 mm <sup>2</sup>
Minimum actuation speed (for head with end plunger)	XE2SP•151, XE2SP2141 and XE3SP: 0.01 m/minute (0.03 ft/minute)	
	XE2NP21•1, XE2NP31•1 and XE3NP: 6 m/minute (19.68 ft/minute)	
Electrical durability	<ul style="list-style-type: none"> <li>Conforming to IEC 60947-5-1 Appendix C</li> <li>Utilization categories AC-15 and DC-13</li> <li>Maximum operating rate: 3600 operating cycles/hour</li> <li>Load factor: 0.5</li> </ul>	

#### XE2SP•151, XE2SP2141

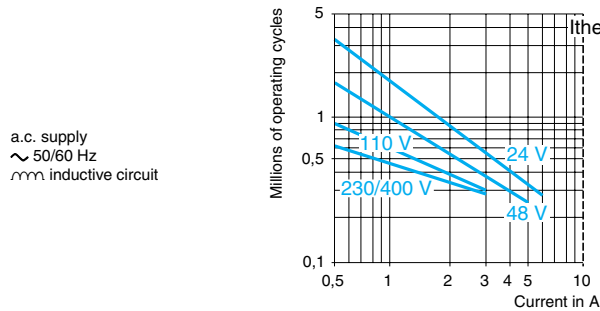

#### XE2NP21•1, XE2NP31•1

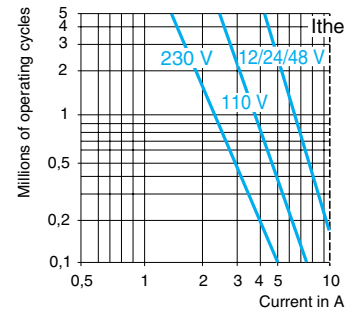

#### Power switched in W for 5 million operating cycles.

Voltage	V	24	48	120
$\square$	W	10	7	4

For XE2SP•151 on  $\sim$  or  $\equiv$ , N/C and N/O contacts simultaneously loaded to the values shown with reverse polarity.

#### XE3NP••••

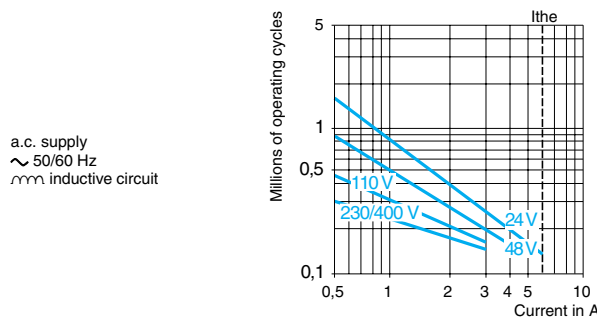

#### Power switched in W for 5 million operating cycles.

Voltage	V	24	48	120
$\square$	W	3	2	1

#### XE3SP••••

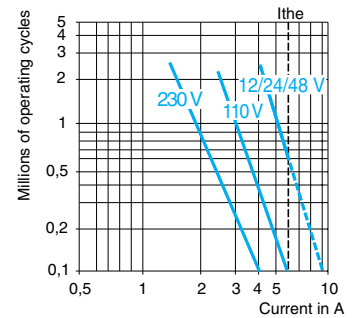

















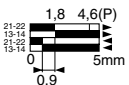
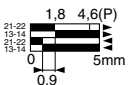
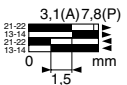
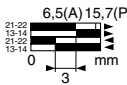
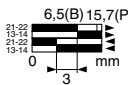
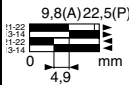

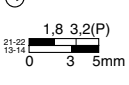
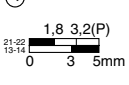
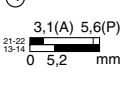
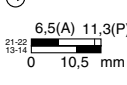
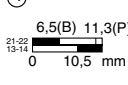
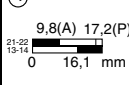



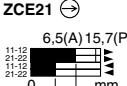
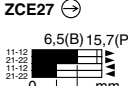

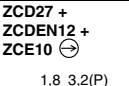
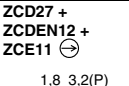
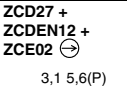
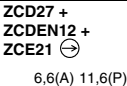
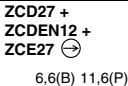
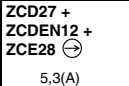

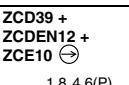
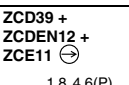
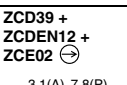
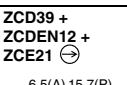
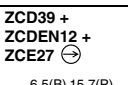
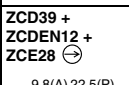

#### Power switched in W for 5 million operating cycles.

Voltage	V	24	48	120
$\square$	W	4	3	2

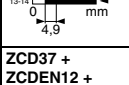
# Limit Switches

## Osiswitch® Compact, Metal

### Universal, XCKD—Complete Units with 1/2" NPT Cable Entry

Type of head	Plunger (mounting by the body)					
	Form B (1)		Form C (1)		Form E (1)	
						
Type of operator	Metal end plunger	Metal end plunger with elastomer boot	Steel roller plunger	Thermoplastic roller lever plunger, horizontal actuation in 1 direction	Thermoplastic roller lever plunger, vertical actuation in 1 direction	Thermoplastic roller lever plunger, horiz. or vert. actuation in 1 direction
<b>Catalog Numbers (2) (3)</b>						
 2-pole N/C + N/O snap action (XE2S P2151)	XCKD2110N12 	XCKD2111N12 	XCKD2102N12 	XCKD2121N12 	XCKD2127N12 	XCKD2128N12 
 2-pole N/C + N/O break before make, slow break (XE2N P2151)	XCKD2510N12 	XCKD2511N12 	XCKD2502N12 	XCKD2521N12 	XCKD2527N12 	XCKD2528N12 
 2-pole N/C + N/C snap action (XE2S P2141)	ZCD29 + ZCDEN12 + ZCE10 	ZCD29 + ZCDEN12 + ZCE11 	ZCD29 + ZCDEN12 + ZCE02 	ZCD29 + ZCDEN12 + ZCE21 	ZCD29 + ZCDEN12 + ZCE27 	ZCD29 + ZCDEN12 + ZCE28 
 2-pole N/C + N/C simultaneous, slow break (XE2N P2141)	ZCD27 + ZCDEN12 + ZCE10 	ZCD27 + ZCDEN12 + ZCE11 	ZCD27 + ZCDEN12 + ZCE02 	ZCD27 + ZCDEN12 + ZCE21 	ZCD27 + ZCDEN12 + ZCE27 	ZCD27 + ZCDEN12 + ZCE28 
 3-pole N/C + N/C + N/O snap action (XE3SP2141)	ZCD39 + ZCDEN12 + ZCE10 	ZCD39 + ZCDEN12 + ZCE11 	ZCD39 + ZCDEN12 + ZCE02 	ZCD39 + ZCDEN12 + ZCE21 	ZCD39 + ZCDEN12 + ZCE27 	ZCD39 + ZCDEN12 + ZCE28 
 3-pole N/C + N/C + N/O break before make, slow break (XE3N P2141)	ZCD37 + ZCDEN12 + ZCE10 	ZCD37 + ZCDEN12 + ZCE11 	ZCD37 + ZCDEN12 + ZCE02 	ZCD37 + ZCDEN12 + ZCE21 	ZCD37 + ZCDEN12 + ZCE27 	ZCD37 + ZCDEN12 + ZCE28 
Weight, kg (lb)	0.180 (0.397)	0.180 (0.397)	0.185 (0.408)	0.195 (0.430)	0.190 (0.419)	0.195 (0.430)
Contact operation	 contact closed  contact open		(A)(B) = cam displacement (P) = positive opening point		 N/C contact with positive opening operation, when properly mounted and using a conforming operator	
<b>Characteristics</b>						
Switch actuation	On end		By 30° cam			
Type of actuation						
Maximum actuation speed	0.5 m/s (1.64 ft/s)		1 m/s (3.28 ft/s)			
Minimum force or torque	For tripping	15 N (3.37 lb)	12 N (2.70 lb)	6 N (1.35 lb)		
	For positive opening	45 N (10.12 lb)	36 N (8.09 lb)	18 N (4.05 lb)		
Cable entry (3)	1 entry tapped M16 x 1.5 mm for ISO cable entry, clamping capacity 4 to 8 mm (0.16 to 0.31 in.)					

- Form conforming to EN 50047, see page 20.
- Switches with gold contacts or ring type connections: please consult your local sales office.
- For an entry tapped for a PG 11 conduit thread, replace N12 in the catalog number with **G11**. Examples: XCKD2110N12 becomes **XCKD2110G11**, ZCDEN12 becomes **ZCDEG11**.

# Limit Switches

## Osiswitch® Compact, Metal

### Universal, XCKD—Complete Units with 1/2" NPT Cable Entry

Type of head	Plunger (mounting by the head)		Rotary (mounting by the body) Form A (1)				Multi-directional
Type of operator	M18 with metal end plunger	M18 with steel roller plunger	Thermoplastic roller lever	Variable length thermoplastic roller lever	Thermoplastic roller lever, Ø 50 mm (1.97 in.)	Variable length thermoplastic roller lever, Ø 50 mm (1.97 in.)	Cat's whisker (3)
<b>Catalog Numbers (2) (4)</b>							
	XCKD21H0N12 2-pole N/C + N/O snap action (XE2S P2151) 	XCKD21H2N12 	XCKD2118N12 	XCKD2145N12 	XCKD2139N12 	XCKD2149N12 	XCKD2106N12 
	XCKD25H0N12 2-pole N/C + N/O break before make, slow break (XE2N P2151) 	XCKD25H2N12 	XCKD2518N12 	XCKD2545N12 	XCKD2539N12 	XCKD2549N12 	XCKD2506N12 
	ZCD29 + ZCDEN12 + ZCEH0 2-pole N/C + N/C snap action (XE2S P2141) 	ZCD29 + ZCDEN12 + ZCEH2 	ZCD29 + ZCDEN12 + ZCE01 + ZCY18 	ZCD29 + ZCDEN12 + ZCE01 + ZCY45 	ZCD29 + ZCDEN12 + ZCE01 + ZCY39 	ZCD29 + ZCDEN12 + ZCE01 + ZCY49 	ZCD29 + ZCDEN12 + ZCE06 
	ZCD27 + ZCDEN12 + ZCEH0 2-pole N/C + N/C simultaneous, slow break (XE2N P2141) 	ZCD27 + ZCDEN12 + ZCEH2 	ZCD27 + ZCDEN12 + ZCE01 + ZCY18 	ZCD27 + ZCDEN12 + ZCE01 + ZCY45 	ZCD27 + ZCDEN12 + ZCE01 + ZCY39 	ZCD27 + ZCDEN12 + ZCE01 + ZCY49 	ZCD27 + ZCDEN12 + ZCE06 
	ZCD39 + ZCDEN12 + ZCEH0 3-pole N/C + N/C + N/O snap action (XE3S P2141) 	ZCD39 + ZCDEN12 + ZCEH2 	ZCD39 + ZCDEN12 + ZCE01 + ZCY18 	ZCD39 + ZCDEN12 + ZCE01 + ZCY45 	ZCD39 + ZCDEN12 + ZCE01 + ZCY39 	ZCD39 + ZCDEN12 + ZCE01 + ZCY49 	ZCD39 + ZCDEN12 + ZCE06 
	ZCD37 + ZCDEN12 + ZCEH0 3-pole N/C + N/C + N/O break before make, slow break (XE3N P2141) 	ZCD37 + ZCDEN12 + ZCEH2 	ZCD37 + ZCDEN12 + ZCE01 + ZCY18 	ZCD37 + ZCDEN12 + ZCE01 + ZCY45 	ZCD37 + ZCDEN12 + ZCE01 + ZCY39 	ZCD37 + ZCDEN12 + ZCE01 + ZCY49 	ZCD37 + ZCDEN12 + ZCE06 
Weight, kg (lb)	0.220 (0.485)	0.220 (0.485)	0.225 (0.496)	0.235 (0.518)	0.235 (0.518)	0.245 (0.540)	0.175 (0.386)
Contact operation	contact closed contact open		(A) = cam displacement (P) = positive opening point		N/C contact with positive opening operation, when properly mounted and using a conforming operator		
<b>Characteristics</b>							
Switch actuation	On end		By 30° cam				By any moving part
Type of actuation							
Maximum actuation speed	0.5 m/s (1.64 ft/s)		1.5 m/s (4.92 ft/s)				1 m/s (3.28 ft/s), any direction
Minimum force or torque	For tripping	15 N (3.37 lb)	10 N (2.25 lb)	0.1 N•m (0.89 lb-in)			0.13 N•m (1.15 lb-in)
	For positive opening	45 N (10.12 lb)	36 N (8.09 lb)	0.25 N•m (2.21 lb-in)			—
Cable entry (4)	1 entry tapped M16 x 1.5 mm for ISO cable entry, clamping capacity 4 to 8 mm (0.16 to 0.31 in.)						

- Form conforming to EN 50047, see page 20.
- Switches with gold contacts or ring type connections: please consult your local sales office.
- Value taken with actuation by moving part at 100 mm (3.94 in.) from the mountings.
- For an entry tapped for a PG 11 conduit thread, replace N12 in the catalog number with **G11**. Examples: XCKD21H0N12 becomes **XCKD21H0G11**, ZCDEN12 becomes **ZCDEG11**.

Note: For more information, consult pages 63, 68–69.

# Limit Switches

## Osiswitch® Compact, Metal

### Universal, XCKD—Complete Units with 1/2" NPT Cable Entry

ZCD2• + ZCDEN12 / ZCD3• + ZCDEN12

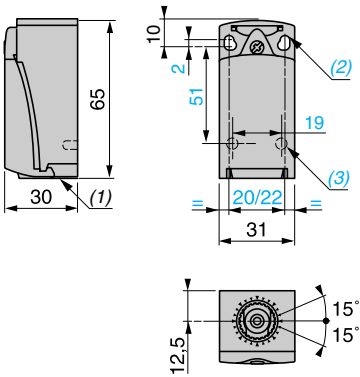

ZCE10

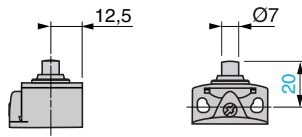

ZCE11

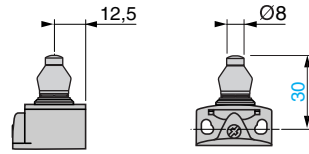

ZCE02

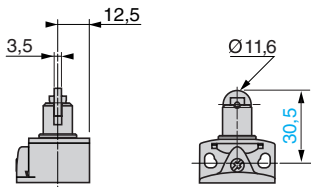

ZCE21

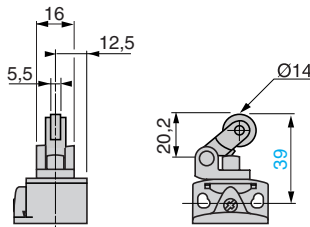

ZCE27

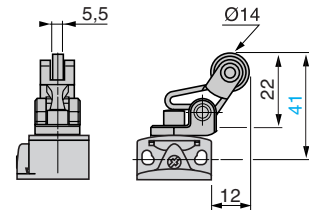

ZCE28

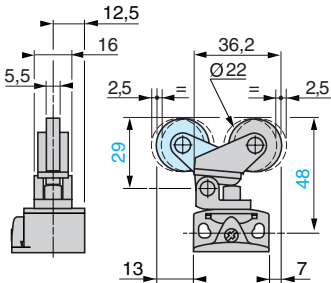

ZCEH0

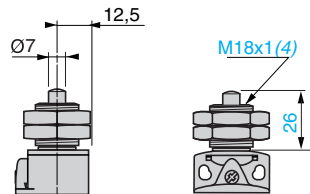

ZCEH2

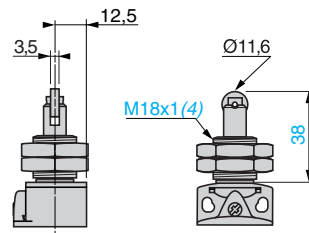

1. Tapped entry for ISO M16 x 1.5 or PG 11 conduit thread.
2. 2 elongated holes  $\text{Ø} 4.3 \times 6.3 \text{ mm}$  (0.17 x 0.25 in.) on 22 mm (0.87 in.) centers, 2 holes  $\text{Ø} 4.3 \text{ mm}$  (0.17 in.) on 20 mm (0.79 in.) centers.
3. 2 x  $\text{Ø} 3$  holes for support studs, depth 4 mm (0.16 in.).
4. Mounting nut thickness 3.5 mm (0.14 in.).

**Limit Switches**  
**Osiswitch® Compact, Metal**  
**Universal, XCKD—Complete Units with 1/2" NPT Cable Entry**

ZCE01 + ZCY18

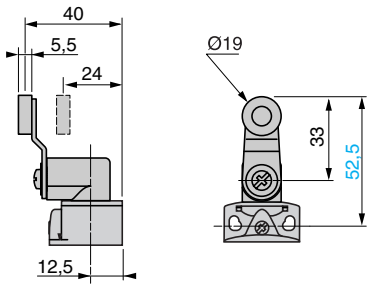

ZCE01 + ZCY45

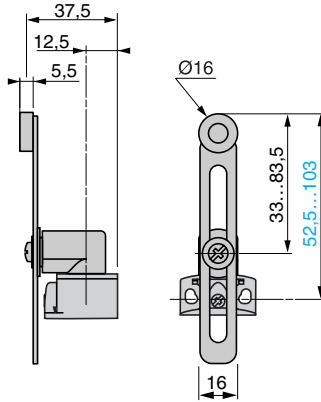

ZCE01 + ZCY39

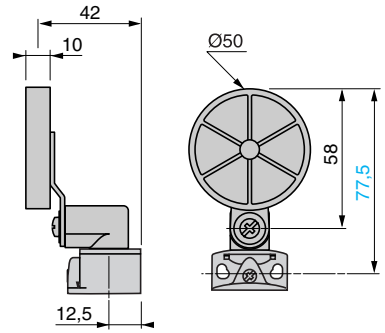

ZCE01 + ZCY49

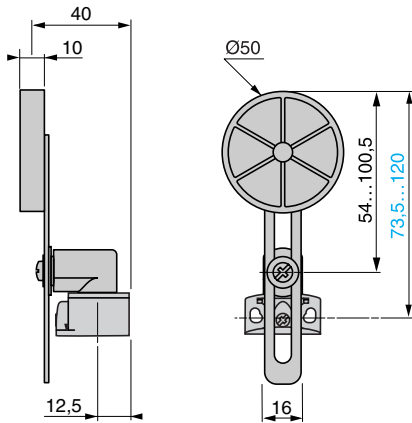

ZCE06

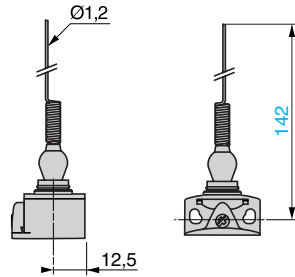

Limit Switches

# Limit Switches

## Osiswitch® Compact, Metal

### Universal, XCKD—Integral M12 Connector

Type of head	Plunger (mounting by the body)					
	Form B (1)		Form C (1)		Form E (1)	
Type of operator	Metal end plunger	Metal end plunger with elastomer boot	Steel roller plunger	Thermoplastic roller lever plunger, horizontal actuation in 1 direction	Thermoplastic roller lever plunger, vertical actuation in 1 direction	Thermoplastic roller lever plunger, horiz. or vert. actuation in 1 direction
<b>Catalog Numbers</b>						
2-pole N/C + N/O snap action (XE2S P2151)	 XCKD2110M12	 XCKD2111M12	 XCKD2102M12	 XCKD2121M12	 XCKD2127M12	 XCKD2128M12
2-pole N/C + N/C snap action (XE2S P2141)	 ZCD29M12 + ZCE10	 ZCD29M12 + ZCE11	 ZCD29M12 + ZCE02	 ZCD29M12 + ZCE21	 ZCD29M12 + ZCE27	 ZCD29M12 + ZCE28
Weight, kg (lb)	0.190 (0.419)	0.190 (0.419)	0.195 (0.430)	0.205 (0.452)	0.200 (0.441)	0.205 (0.452)
Contact operation	(A) (B) = cam displacement (P) = positive opening point					

1. Form conforming to EN 50047, see page 20.

<b>Characteristics</b>	
Switch actuation	On end  By 30° cam
Type of actuation	
Maximum actuation speed	0.5 m/s (1.64 ft/s) <span style="margin-left: 150px;">1 m/s (3.28 ft/s)</span>
Minimum force or torque	For tripping: 15 N (3.37 lb) <span style="margin-left: 150px;">12 N (2.70 lb)</span> <span style="margin-left: 150px;">6 N (1.35 lb)</span> For positive opening: 45 N (10.12 lb) <span style="margin-left: 150px;">36 N (8.09 lb)</span> <span style="margin-left: 150px;">18 N (4.05 lb)</span>
Connection	M12 5-pin connector, Ui = 60 V, Ie = 4 A maximum, Ith = 4 A

### Connections

#### Integral M12 connector

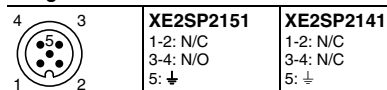

### Dimensions

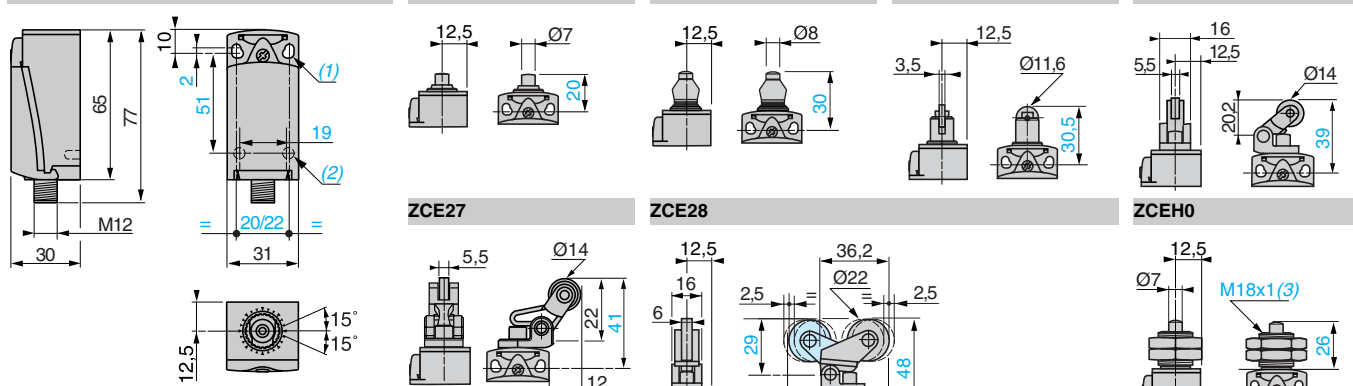

- 2 elongated holes  $\varnothing 4.3 \times 6.3$  mm (0.17 x 0.25 in.) on 22 mm (0.87 in.) centers, 2 holes  $\varnothing 4.3$  mm (0.17 in.) on 20 mm (0.79 in.) centers.
- 2 x  $\varnothing 3$  holes for support studs, depth 4 mm (0.16 in.).
- Mounting nut thickness 3.5 mm (0.14 in.).

Limit Switches

# Limit Switches

## Osiswitch® Compact, Metal

### Universal, XCKD—Integral M12 Connector

Type of head	Plunger (mounting by the head)		Rotary (mounting by the body) Form A (1)				Multi-directional
Type of operator	M18 with metal end plunger	M18 with steel roller plunger	Thermoplastic roller lever	Variable length thermoplastic roller lever	Thermoplastic roller lever, Ø 50 mm (1.97 in.)	Variable length thermoplastic roller lever, Ø 50 mm (1.97 in.)	Cat's whisker (2)
<b>Catalog Numbers</b>							
2-pole N/C + N/O snap action (XE2S P2151)	XCKD21H0M12 	XCKD21H2M12 	XCKD2118M12 	XCKD2145M12 	XCKD2139M12 	XCKD2149M12 	XCKD2106M12 
2-pole N/C + N/C snap action (XE2S P2141)	ZCD29M12 + ZCEH0 	ZCD29M12 + ZCEH2 	ZCD29M12 + ZCE01 + ZCY18 	ZCD29M12 + ZCE01 + ZCY45 	ZCD29M12 + ZCE01 + ZCY39 	ZCD29M12 + ZCE01 + ZCY49 	ZCD29M12 + ZCE06 
Weight, kg (lb)	0.235 (0.518)	0.235 (0.518)	0.220 (0.485)	0.220 (0.485)	0.220 (0.485)	0.220 (0.485)	0.185 (0.408)

**Contact operation**

contact closed (A) = cam displacement  
 contact open (P) = positive opening point

1. Form conforming to EN 50047, see page 20.  
 2. Value taken with actuation by moving part at 100 mm (3.94 in.) from the mounting.

Switch actuation		On end	By 30° cam	By any moving part	
Type of actuation					
Maximum actuation speed		0.5 m/s (1.64 ft/s)		1.5 m/s (4.92 ft/s)	
Minimum force or torque	For tripping	15 N (3.37 lb)	10 N (2.25 lb)	0.13 N•m (1.15 lb-in)	
	For positive opening	45 N (10.12 lb)	36 N (8.09 lb)	0.25 N•m (2.21 lb-in)	
Connection		M12 5-pin connector, U <sub>i</sub> = 60 V, I <sub>e</sub> = 4 A maximum, I <sub>th</sub> = 4 A			

### Dimensions

ZCE01 + ZCY18      ZCE01 + ZCY45      ZCE01 + ZCY39      ZCE01 + ZCY49      ZCE06

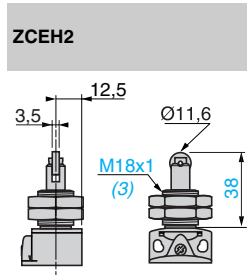
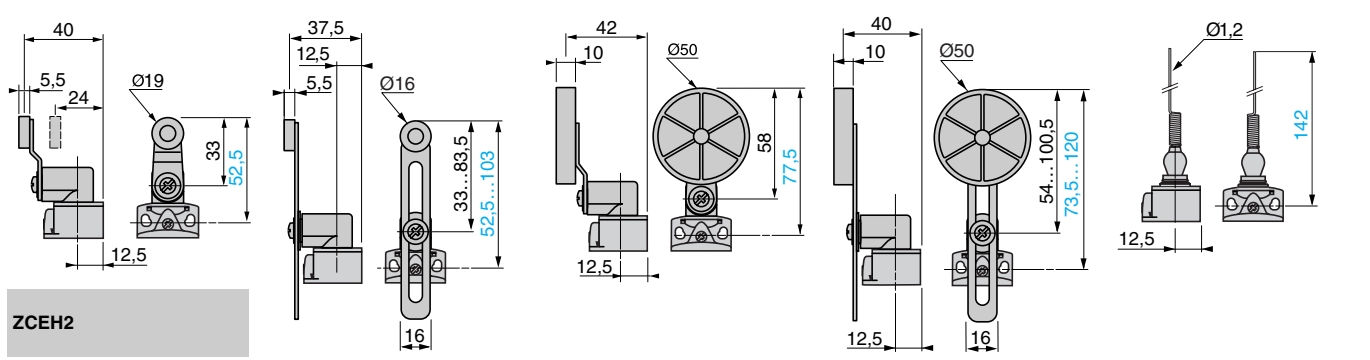

3. Mounting nut thickness 3.5 mm (0.14 in.)

Limit Switches

# Limit Switches

## Osiswitch® Compact, Plastic

### Universal, XCKP—Complete Units with 1/2" NPT Cable Entry

Type of head		Plunger (mounting by the body)					
		Form B (1)		Form C (1)		Form E (1)	
Type of operator		Metal end plunger	Metal end plunger with elastomer boot	Steel roller plunger	Thermoplastic roller lever plunger, horizontal actuation in 1 direction	Thermoplastic roller lever plunger, vertical actuation in 1 direction	Thermoplastic roller lever plunger, horiz. or vert. actuation in 1 direction
<b>Catalog Numbers (2) (3)</b>							
<p>2-pole N/C + N/O snap action (XE2S P2151)</p>	XCKP2110N12	XCKP2111N12	XCKP2102N12	XCKP2121N12	XCKP2127N12	XCKP2128N12	
<p>2-pole N/C + N/O break before make, slow break (XE2N P2151)</p>	XCKP2510N12	XCKP2511N12	XCKP2502N12	XCKP2521N12	XCKP2527N12	XCKP2528N12	
<p>2-pole N/C + N/C snap action (XE2S P2141)</p>	ZCP29 + ZCPEN12 + ZCE10	ZCP29 + ZCPEN12 + ZCE11	ZCP29 + ZCPEN12 + ZCE02	ZCP29 + ZCPEN12 + ZCE21	ZCP29 + ZCPEN12 + ZCE27	ZCP29 + ZCPEN12 + ZCE28	
<p>2-pole N/C + N/C simultaneous, slow break (XE2N P2141)</p>	ZCP27 + ZCPEN12 + ZCE10	ZCP27 + ZCPEN12 + ZCE11	ZCP27 + ZCPEN12 + ZCE02	ZCP27 + ZCPEN12 + ZCE21	ZCP27 + ZCPEN12 + ZCE27	ZCP27 + ZCPEN12 + ZCE28	
<p>3-pole N/C + N/C + N/O snap action (XE3S P2141)</p>	ZCP39 + ZCPEN12 + ZCE10	ZCP39 + ZCPEN12 + ZCE11	ZCP39 + ZCPEN12 + ZCE02	ZCP39 + ZCPEN12 + ZCE21	ZCP39 + ZCPEN12 + ZCE27	ZCP39 + ZCPEN12 + ZCE28	
<p>3-pole N/C + N/C + N/O break before make, slow break (XE3N P2141)</p>	ZCP37 + ZCPEN12 + ZCE10	ZCP37 + ZCPEN12 + ZCE11	ZCP37 + ZCPEN12 + ZCE02	ZCP37 + ZCPEN12 + ZCE21	ZCP37 + ZCPEN12 + ZCE27	ZCP37 + ZCPEN12 + ZCE28	
Weight, kg (lb)	0.090 (0.198)	0.090 (0.198)	0.095 (0.209)	0.105 (0.231)	0.100 (0.220)	0.105 (0.231)	
Contact operation			(A)(B) = cam displacement (P) = positive opening point				
<b>Characteristics</b>							
Switch actuation	On end			By 30° cam			
Type of actuation							
Maximum actuation speed	0.5 m/s (1.64 ft/s)			1 m/s (3.28 ft/s)			
Minimum force or torque	For tripping	15 N (3.37 lb)		12 N (2.70 lb)	6 N (1.35 lb)		
	For positive opening	45 N (10.12 lb)		36 N (8.09 lb)	18 N (4.05 lb)		
Cable entry (3)	1 entry tapped M16 x 1.5 mm for ISO cable entry, clamping capacity 4 to 8 mm (0.16 to 0.31 in.)						

- Form conforming to EN 50047, see page 20.
  - Switches with gold contacts or ring type connections: please consult your local sales office.
  - For an entry tapped for a PG 11 conduit thread, replace N12 in the catalog number with **G11**. Examples: XCKP2110N12 becomes **XCKP2110G11**, ZCPEN12 becomes **ZCPEN12G11**.
- Note:** For more information, consult pages 63, 68–69.



# Limit Switches

## Osiswitch® Compact, Plastic

### Universal, XCKP—Complete Units with 1/2" NPT Cable Entry

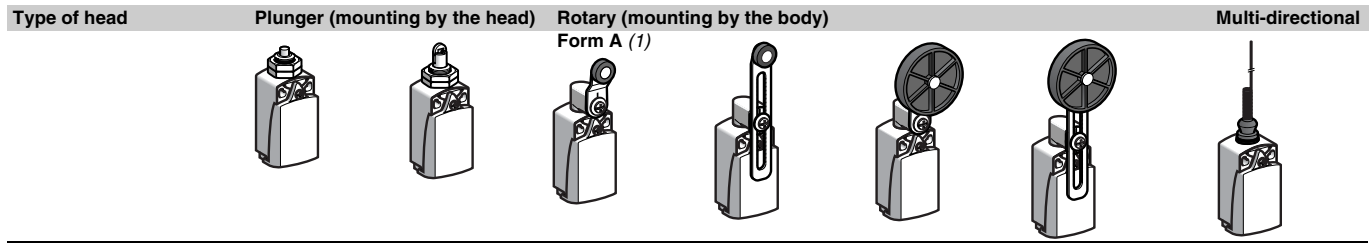

Type of operator	M18 with metal end plunger	M18 with steel roller plunger	Thermoplastic roller lever	Variable length thermoplastic roller lever	Thermoplastic roller lever, Ø 50 mm (1.97 in.)	Variable length thermoplastic roller lever, Ø 50 mm (1.97 in.)	Cat's whisker (4)
------------------	----------------------------	-------------------------------	----------------------------	--	--	--	-------------------

#### Catalog Numbers (2)

	XCKP21H0N12	XCKP21H2N12	XCKP2118N12	XCKP2145N12	XCKP2139N12	XCKP2149N12	XCKP2106N12
<p>2-pole N/C + N/O snap action (XE2S P2151)</p>	<p>1,8 4,6(P) 0,9 5mm</p>	<p>3,1(A) 7,8(P) 1,5 mm</p>	<p>25° 70°(P) 12° 90°</p>	<p>25° 70°(P) 12° 90°</p>	<p>25° 70°(P) 12° 90°</p>	<p>25° 70°(P) 12° 90°</p>	<p>20° 15°</p>
<p>2-pole N/C + N/O break before make, slow break (XE2NP2151)</p>	<p>1,8 3,2(P) 0 3 5mm</p>	<p>3,1(A) 5,6(P) 0 5,2 mm</p>	<p>25° 46°(P) 0 42° 90°</p>	<p>25° 46°(P) 0 42° 90°</p>	<p>25° 46°(P) 0 42° 90°</p>	<p>25° 46°(P) 0 42° 90°</p>	<p>20° 0 45°</p>
<p>2-pole N/C + N/C snap action (XE2SP2141)</p>	<p>1,8 4,6(P) 0,9 5mm</p>	<p>3,1(A) 7,8(P) 1,5 mm</p>	<p>25° 70°(P) 12° 90°</p>	<p>25° 70°(P) 12° 90°</p>	<p>25° 70°(P) 12° 90°</p>	<p>25° 70°(P) 12° 90°</p>	<p>20° 15°</p>
<p>2-pole N/C + N/C simultaneous, slow break (XE2NP2141)</p>	<p>1,8 3,2(P) 0 3 5mm</p>	<p>3,1 5,6(P) 0 5,2 mm</p>	<p>25° 46°(P) 0 42° 90°</p>	<p>25° 46°(P) 0 42° 90°</p>	<p>25° 46°(P) 0 42° 90°</p>	<p>25° 46°(P) 0 42° 90°</p>	<p>20° 0 45°</p>
<p>3-pole N/C + N/C + N/O snap action (XE3SP2141)</p>	<p>1,8 4,6(P) 0,9 5mm</p>	<p>3,1(A) 7,8(P) 1,5 mm</p>	<p>25° 70°(P) 12° 90°</p>	<p>25° 70°(P) 12° 90°</p>	<p>25° 70°(P) 12° 90°</p>	<p>25° 70°(P) 12° 90°</p>	<p>20° 15°</p>
<p>3-pole N/C + N/C + N/O break before make, slow break (XE3NP2141)</p>	<p>1,8 3,2(P) 0 3 5mm</p>	<p>3,1(A) 5,6(P) 0 5,2 mm</p>	<p>25° 46°(P) 0 42° 90°</p>	<p>25° 46°(P) 0 42° 90°</p>	<p>25° 46°(P) 0 42° 90°</p>	<p>25° 46°(P) 0 42° 90°</p>	<p>20° 0 45°</p>
Weight, kg (lb)	0.130 (0.287)	0.130 (0.287)	0.135 (0.298)	0.145 (0.320)	0.145 (0.320)	0.155 (0.342)	0.085 (0.187)

<b>Contact operation</b> 	(A) = cam displacement (P) = positive opening point	☉ N/C contact with positive opening operation, when properly mounted and using a conforming operator
------------------------------	--	--

#### Characteristics

Switch actuation	On end	By 30° cam			By any moving part
Type of actuation					
Maximum actuation speed	0.5 m/s (1.64 ft/s)	1.5 m/s (4.92 ft/s)			1 m/s (3.28 ft/s), any direction
Minimum force or torque	For tripping: 15 N (3.37 lb) For positive opening: 45 N (10.12 lb)	10 N (2.25 lb)	0.1 N•m (0.89 lb-in)		0.13 N•m (1.15 lb-in)
Cable entry (3)	1 entry tapped M16 x 1.5 mm for ISO cable entry, clamping capacity 4 to 8 mm (0.16 to 0.31 in.)				

1. Form conforming to EN 50047, see page 20.  
 2. Switches with gold contacts or ring type connections: please consult your local sales office.  
 3. For an entry tapped for a PG 11 conduit thread, replace N12 in the catalog number with G11. Examples: XCKP21H0N12 becomes XCKP21H0G11, ZCPEN12 becomes ZCPEG11.  
 4. Value taken with actuation by moving part at 100 mm (3.94 in.) from the mountings.  
 NOTE: For more information, consult pages 63, 68–69.

# Limit Switches

## Osiswitch® Compact, Plastic

### Universal, XCKP—Complete Units with 1/2" NPT Cable Entry

ZCP2• + ZCPEN12 / ZCP3• + ZCPEN12

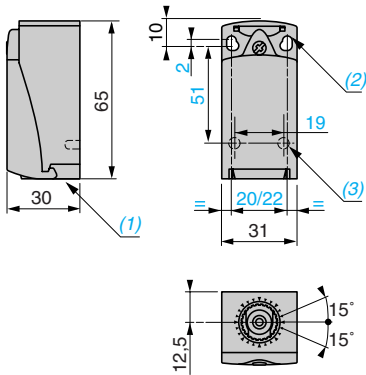

ZCE10

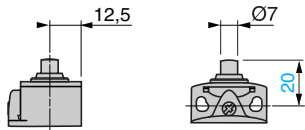

ZCE11

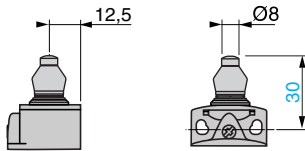

ZCE28

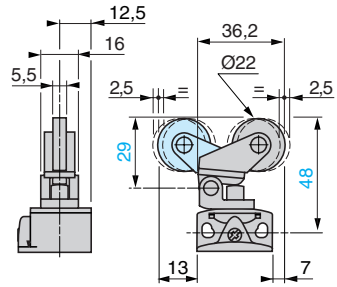

ZCE02

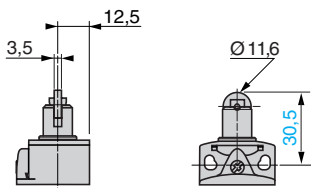

ZCE21

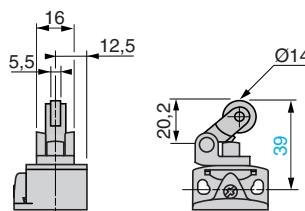

ZCE27

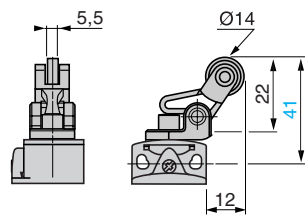

ZCE06

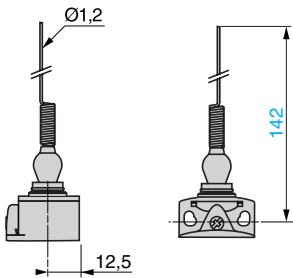

ZCEH0

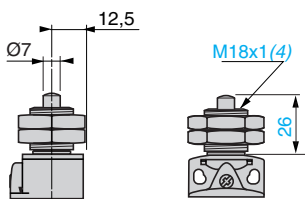

ZCE01 + ZCY18

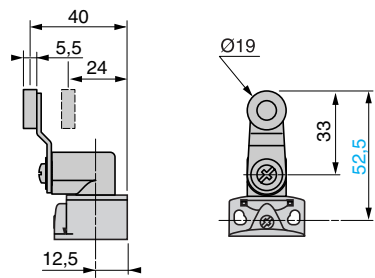

ZCEH2

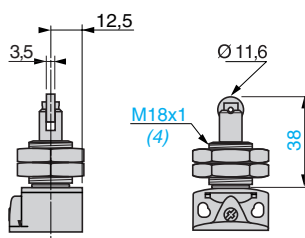

ZCE01 + ZCY45

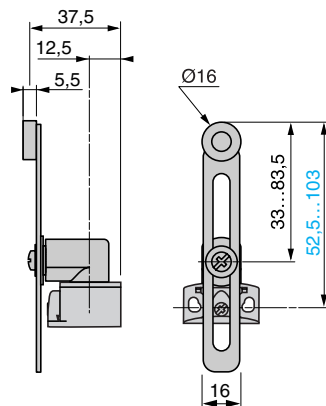

ZCE01 + ZCY49

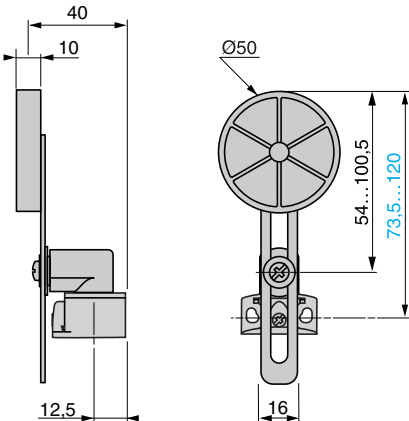

ZCE01 + ZCY39

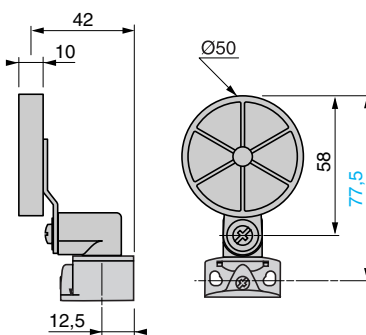

1. Tapped entry for ISO M16 x 1.5 or PG 11 conduit thread.
2. 2 elongated holes Ø 4.3 x 6.3 mm (0.17 x 0.25 in.) on 22 mm (0.87 in.) centers, 2 holes Ø 4.3 mm (0.17 in.) on 20 mm (0.79 in.) centers.

3. 2 x Ø 3 holes for support studs, depth 4 mm (0.16 in.).
4. Mounting nut thickness 3.5 mm (0.14 in.).

# Limit Switches

## Osiswitch® Compact, Metal and Plastic Universal, XCKD, XCKP, and XCKT

### Catalog Number Interpretation

For Interpretation of the Catalog Number Only

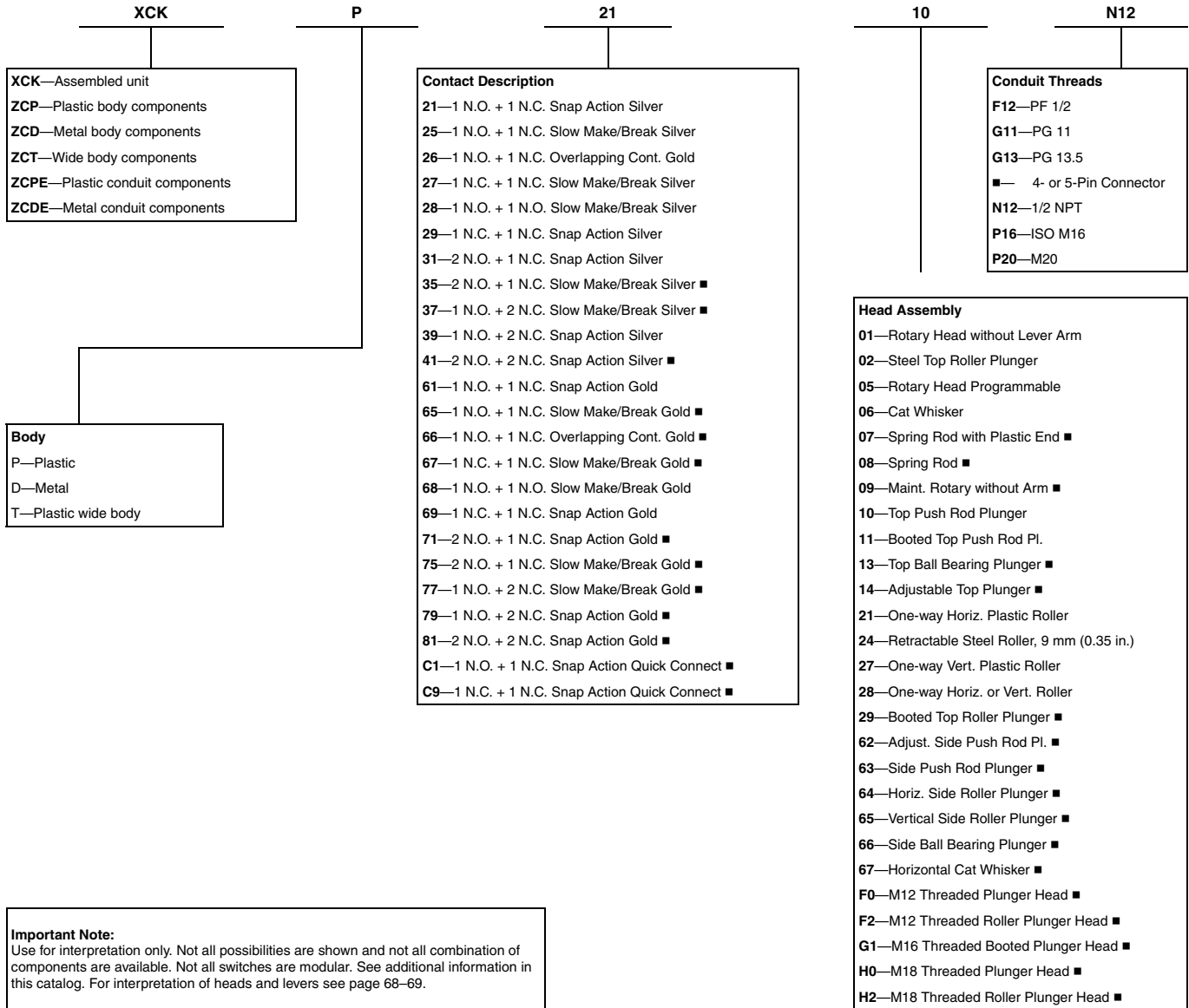

■ Call your local field sales office for availability.

Limit Switches

# Limit Switches

## Osiswitch® Compact, Plastic

### Universal, XCKP—Integral M12 Connector

Type of head	Plunger (mounting by the body)					
	Form B (1)		Form C (1)	Form E (1)		
Type of operator	Metal end plunger	Metal end plunger with elastomer boot	Steel roller plunger	Thermoplastic roller lever plunger, horizontal actuation in 1 direction	Thermoplastic roller lever plunger, vertical actuation in 1 direction	Thermoplastic roller lever plunger, horiz. or vert. actuation in 1 direction
<b>Catalog Numbers</b>						
2-pole N/C + N/O snap action (XE2S P2151)	XCKP2110M12 	XCKP2111M12 	XCKP2102M12 	XCKP2121M12 	XCKP2127M12 	XCKP2128M12 
2-pole N/C + N/C snap action (XE2S P2141)	ZCP29M12 + ZCE10 	ZCP29M12 + ZCE11 	ZCP29M12 + ZCE02 	ZCP29M12 + ZCE21 	ZCP29M12 + ZCE27 	ZCP29M12 + ZCE28 
Weight, kg (lb)	0.100 (0.220)	0.100 (0.220)	0.100 (0.220)	0.110 (0.243)	0.110 (0.243)	0.110 (0.243)
Contact operation			(A)(B) = cam displacement (P) = positive opening point			

1. Form conforming to EN 50047, see page 20.

Characteristics	
Switch actuation	On end   By 30° cam
Type of actuation	
Maximum actuation speed	0.5 m/s (1.64 ft/s)   1 m/s (3.28 ft/s)
Minimum force or torque	For tripping: 15 N (3.37 lb)   12 N (2.70 lb)   6 N (1.35 lb)
	For positive opening: 45 N (10.12 lb)   36 N (8.09 lb)   18 N (4.05 lb)
Connection	M12 4-pin connector, Ui = 250 V, Ie = 3 A maximum, Ith = 3 A

### Connections

#### Integral M12 connector

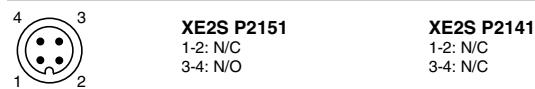

### Dimensions

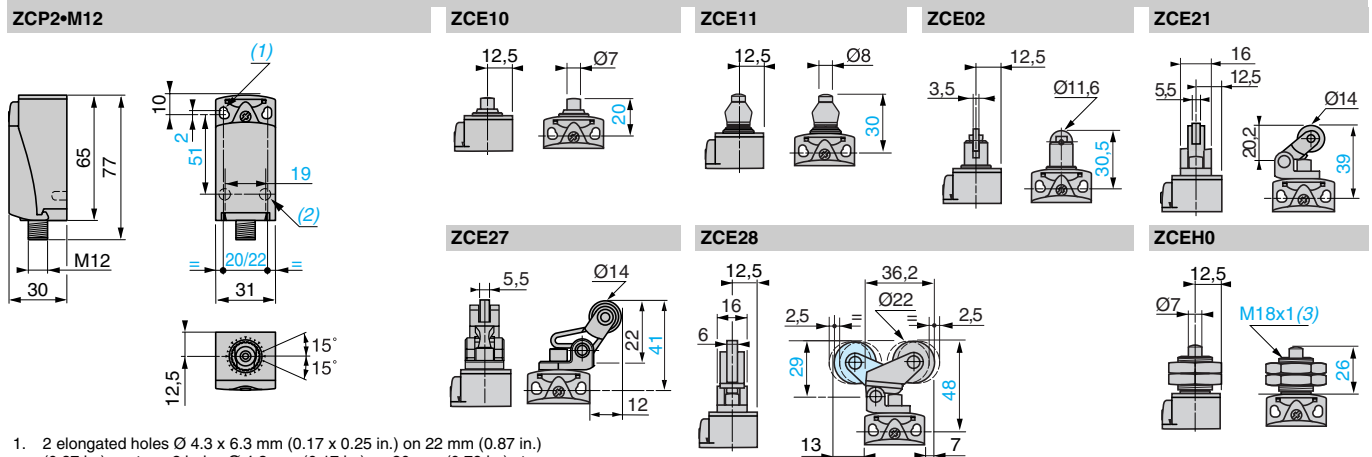

- 2 elongated holes  $\varnothing 4.3 \times 6.3$  mm (0.17 x 0.25 in.) on 22 mm (0.87 in.) centers, 2 holes  $\varnothing 4.3$  mm (0.17 in.) on 20 mm (0.79 in.) ctrs.
- 2 x  $\varnothing 3$  mm (0.12 in.) holes for support studs, depth 4 mm (0.16 in.).
- Mounting nut thickness 3.5 mm (0.14 in.).

# Limit Switches

## Osiswitch® Compact, Plastic

### Universal, XCKP—Integral M12 Connector

Type of head	Plunger (mounting by the head)		Rotary (mounting by the body)				Multi-directional
			Form A (1)				
Type of operator	M18 with metal end plunger	M18 with steel roller plunger	Thermoplastic roller lever	Variable length thermoplastic roller lever	Thermoplastic roller lever, Ø 50 mm (1.97 in.)	Variable length thermoplastic roller lever, Ø 50 mm (1.97 in.)	Cat's whisker (2)

Catalog Numbers							
2-pole N/C + N/O snap action (XE2SP2151)	XCKP21H0M12	XCKP21H2M12	XCKP2118M126	XCKP2145M12	XCKP2139M12	XCKP2149M12	XCKP2106M126
2-pole N/C + N/C snap action (XE2S P2141)	ZCP29M12 + ZCEH0	ZCP29M12 + ZCEH2	ZCP29M12 + ZCE01 + ZCY18	ZCP29M12 + ZCE01 + ZCY45	ZCP29M12 + ZCE01 + ZCY39	ZCP29M12 + ZCE01 + ZCY49	ZCP29M12 + ZCE06
Weight, kg (lb)	0.140 (0.309)	0.140 (0.309)	0.140 (0.309)	0.150 (0.331)	0.155 (0.342)	0.160 (0.353)	0.090 (0.198)

**Contact operation** contact closed (A) = cam displacement N/C contact with positive opening operation, when properly mounted and using a conforming operator  
 contact open (P) = positive opening point

- Form conforming to EN 50047, see page 20.
- Value taken with actuation by moving part at 100 mm (3.94 in.) from the mountings.

Characteristics				
Switch actuation	On end	By 30° cam		By any moving part
Type of actuation				
Maximum actuation speed	0.5 m/s (1.64 ft/s)		1.5 m/s (4.92 ft/s)	
Minimum force or torque	For tripping	15 N (3.37 lb)	10 N (2.25 lb)	0.1 N•m (0.89 lb-in)
	For positive opening	45 N (10.12 lb)	36 N (8.09 lb)	0.25 N•m (2.21 lb-in)
Connection	M12 4-pin connector, U <sub>i</sub> = 250 V, I <sub>e</sub> = 3 A maximum, I <sub>th</sub> = 3 A			

### Dimensions

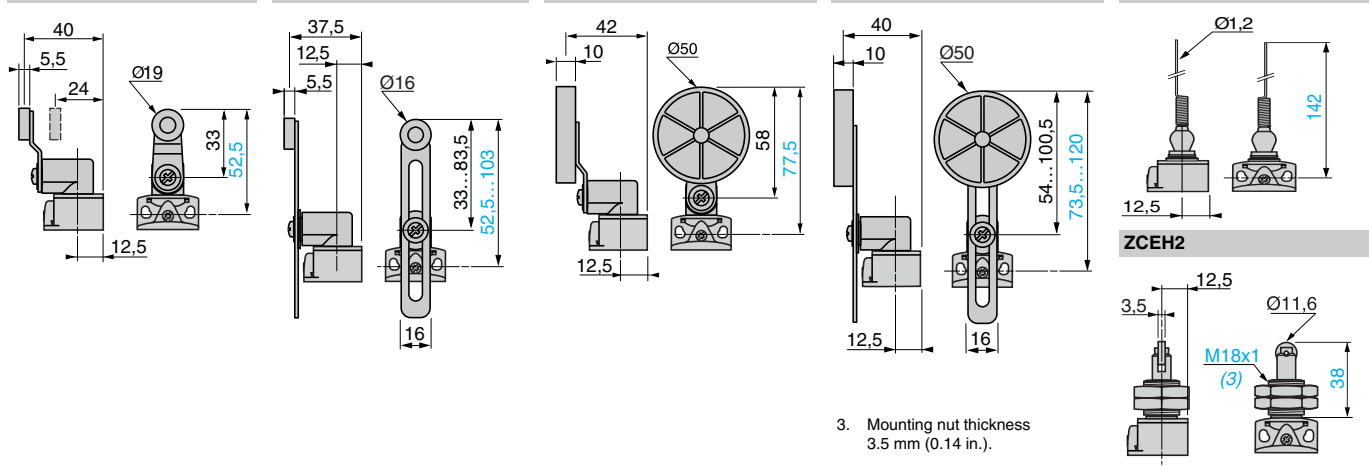









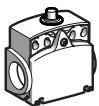

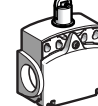

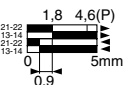
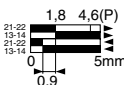
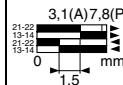
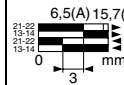

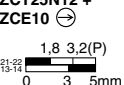
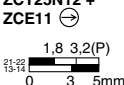
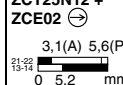
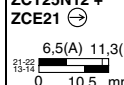

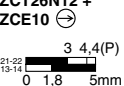
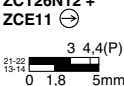
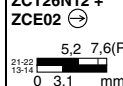
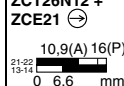
Limit Switches

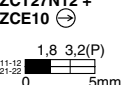
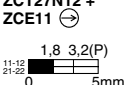
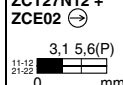
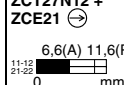
# Limit Switches

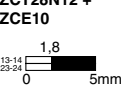
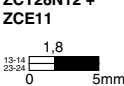
## Osiswitch® Compact, Plastic

### Universal, XCKT—Complete Units with Two Cable Entries and 1/2" NPT Adapter

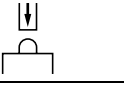
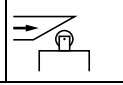
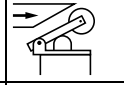
Type of head	Plunger (mounting by the body)			Multi-directional
	Form B (1)	Form C (1)	Form E (1)	
				
Type of operator	Metal end plunger	Metal end plunger with elastomer boot	Steel roller plunger	Thermoplastic roller lever plunger, horizontal actuation in 1 direction
<b>Catalog Numbers (2) (3)</b>				
 2-pole N/C + N/O snap action (XE2SP3151)	XCKT2110N12 ⊖ 	XCKT2111N12 ⊖ 	XCKT2102N12 ⊖ 	XCKT2121N12 ⊖ 
 2-pole N/C + N/O break before make, slow break (XE2NP3151)	ZCT25N12 + ZCE10 ⊖ 	ZCT25N12 + ZCE11 ⊖ 	ZCT25N12 + ZCE02 ⊖ 	ZCT25N12 + ZCE21 ⊖ 
 2-pole N/C + N/O make before break, slow break (XE2N P3161)	ZCT26N12 + ZCE10 ⊖ 	ZCT26N12 + ZCE11 ⊖ 	ZCT26N12 + ZCE02 ⊖ 	ZCT26N12 + ZCE21 ⊖ 
 2-pole N/C + N/C simultaneous, slow break (XE2N P3141)	ZCT27N12 + ZCE10 ⊖ 	ZCT27N12 + ZCE11 ⊖ 	ZCT27N12 + ZCE02 ⊖ 	ZCT27N12 + ZCE21 ⊖ 
 2-pole N/O + N/O simultaneous, slow break (XE2NP3131)	ZCT28N12 + ZCE10 ⊖ 	ZCT28N12 + ZCE11 ⊖ 	ZCT28N12 + ZCE02 ⊖ 	ZCT28N12 + ZCE21 ⊖ 
Weight, kg (lb)	0.100 (0.220)	0.100 (0.220)	0.105 (0.231)	0.115 (0.254)
Contact operation	 contact closed  contact open	(A) = cam displacement (P) = positive opening point		⊖ N/C contact with positive opening operation, when properly mounted and using a conforming operator
<b>Characteristics</b>				
Switch actuation	On end	By 30° cam		By any moving part
Type of actuation				
Maximum actuation speed	0.5 m/s (1.64 ft/s)		1 m/s (3.28 ft/s)	1 m/s (3.28 ft/s), any direction
Minimum force or torque	For tripping For positive opening	15 N (3.37 lb) 45 N (10.12 lb)	12 N (2.70 lb) 36 N (8.09 lb)	6 N (1.35 lb) 18 N (4.05 lb)
Cable entry (3)	2 entries tapped M16 x 1.5 for ISO cable entry. Clamping capacity 4 to 8 mm (0.16 to 0.31 in.) (1 entry fitted with blanking plug).			

- Form conforming to EN 50047, see page 20.
- Switches with gold contacts or ring connections: please consult your local sales office.
- For cable entries tapped for a PG 11 conduit thread, replace N12 in the catalog number with G11. Example: XCKT2110N12 becomes XCKT2110G11.
- Value taken with actuation by moving part at 100 mm (3.94 in.) from the mountings.

### Dimensions

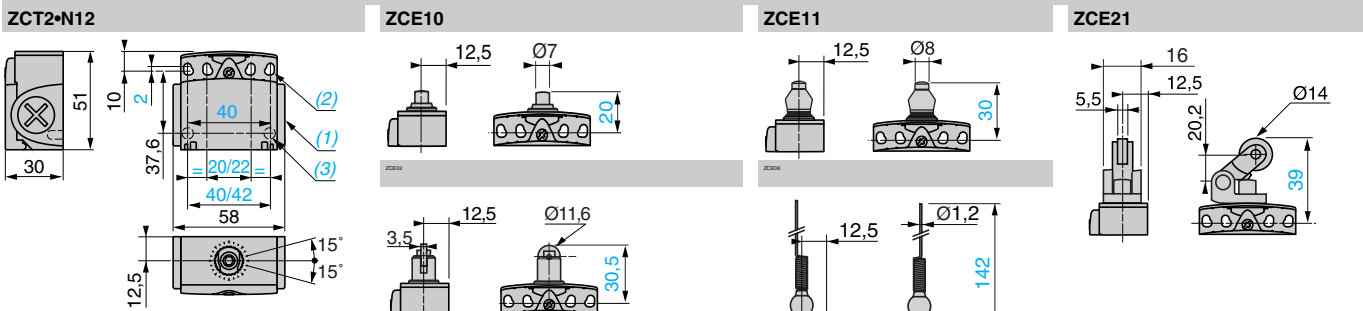









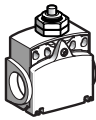
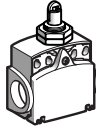

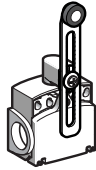
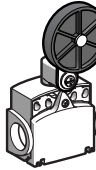
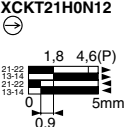
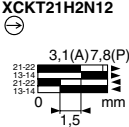
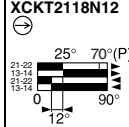
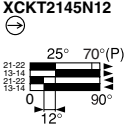
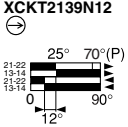
- 2 tapped entries for ISO M16 x 1.5 or PG 11 conduit thread.
- 4 elongated holes Ø 4.3 x 6.3 mm (0.17 x 0.25 in.) on 22/42 mm (0.87/1.65 in.) ctrs., 4 holes Ø 4.3 mm (0.17 in.) on 20/40 mm (0.79/1.57 in.) ctrs.
- 2 x Ø 3 holes for support studs, depth 4 mm (0.16 in.).

# Limit Switches

## Osiswitch® Compact, Plastic

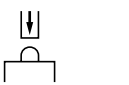
### Universal, XCKT—Complete Units with Two Cable Entries and 1/2" NPT Adapter

Type of head	Plunger (mounting by the head)		Rotary (mounting by the body) Form A (1)		
					
Type of operator	M18 with metal end plunger	M18 with steel roller plunger	Thermoplastic roller lever	Variable length thermoplastic roller lever	Thermoplastic roller lever, Ø 50 mm (1.97 in.)
Catalog Numbers (2) (3)	<b>XCKT21H0N12</b> 	<b>XCKT21H2N12</b> 	<b>XCKT2118N12</b> 	<b>XCKT2145N12</b> 	<b>XCKT2139N12</b> 
	2-pole N/C + N/O snap action (XE2S P3151)				
	2-pole N/C + N/O break before make, slow break (XE2N P3151)				
	2-pole N/O + N/C make before break, slow break (XE2N P3161)				
	2-pole N/C + N/C simultaneous, slow break (XE2N P3141)				
	2-pole N/O + N/O simultaneous, slow break (XE2NP3131)				
Weight, kg (lb)	0.145 (0.320)	0.145 (0.320)	0.145 (0.320)	0.155 (0.342)	0.160 (0.353)
Contact operation	■ contact closed (A) = cam displacement □ contact open (P) = positive opening point		⊕ N/C contact with positive opening operation, when properly mounted and using a conforming operator		
Characteristics					
Switch actuation	On end	By 30° cam			
Type of actuation					
Maximum actuation speed	0.5 m/s (1.64 ft/s)		1.5 m/s (4.92 ft/s)		
Minimum force or torque	For tripping	15 N (3.37 lb)	10 N (2.25 lb)	0.1 N•m (0.89 lb-in)	
	For positive opening	45 N (10.12 lb)	36 N (8.09 lb)	0.25 N•m (2.21 lb-in)	
Cable entry (3)	2 entries tapped M16 x 1.5 for ISO cable entry. Clamping capacity 4 to 8 mm (0.16 to 0.31 in.) (1 entry fitted with blanking plug).				

- Form conforming to EN 50047, see page 20.
- Switches with gold contacts or ring type connections: please consult your local sales office.
- For cable entries tapped for a PG 11 conduit thread, replace N12 in the catalog number with **G11**. Example: XCKT21H0N12 becomes **XCKT21H0G11**.

### Dimensions

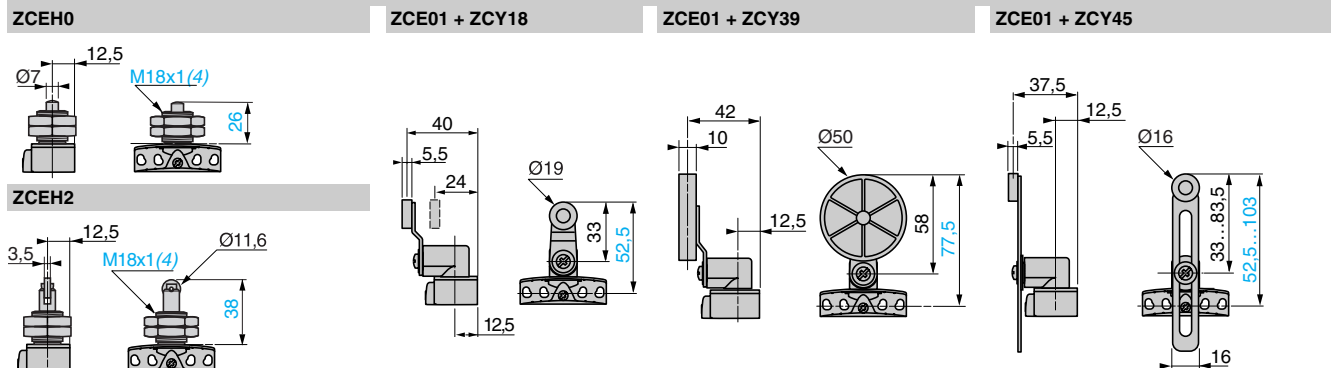

- Mounting nut thickness 3.5 mm (0.14 in.)



# Limit Switches

## Osiswitch® Compact, Metal and Plastic

### Universal, XCKD, XCKP, and XCKT—Modular

Limit Switches

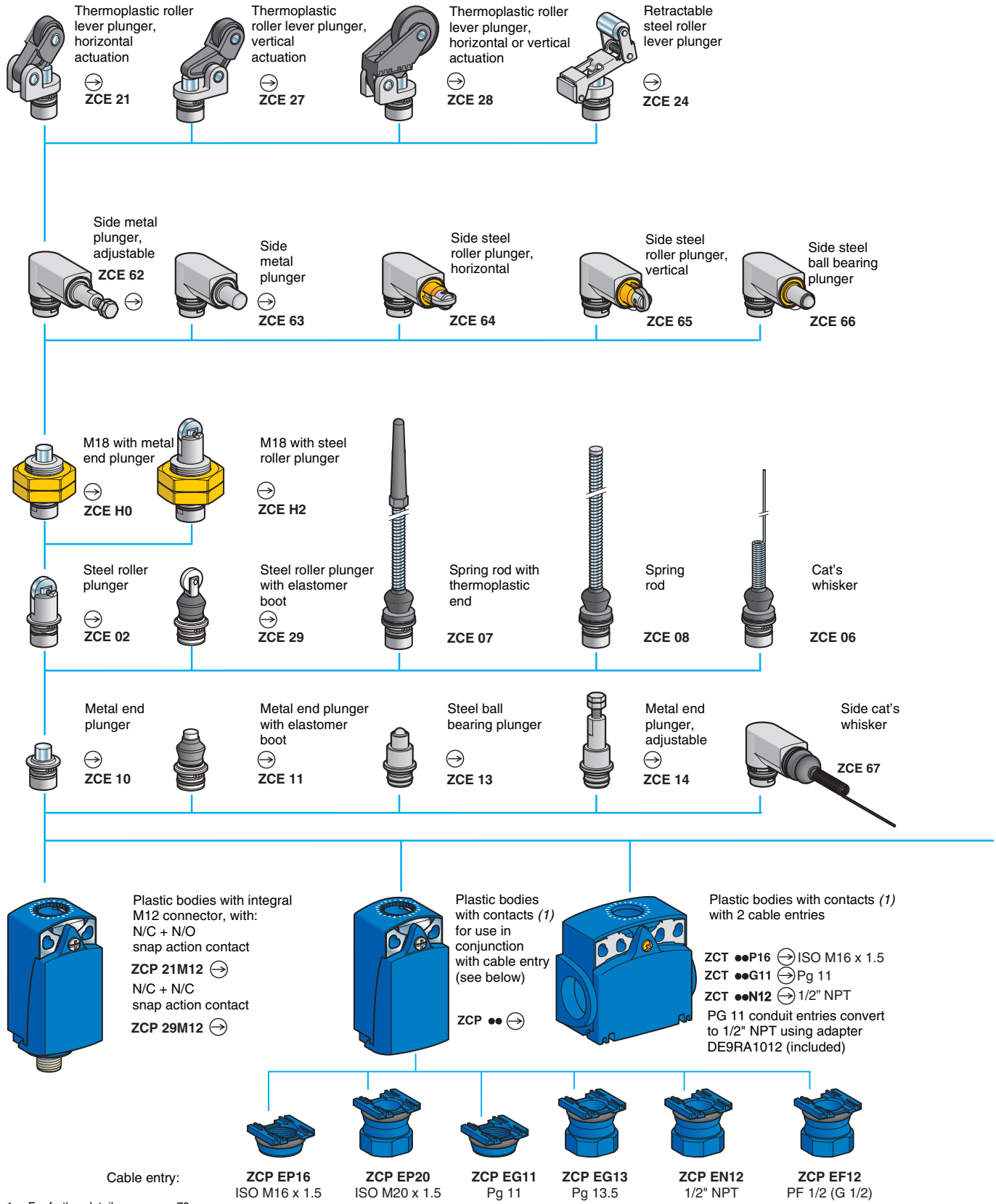

1. For further details, see page 70.  
2. Cannot be used on bodies: ZCD21, ZCP21, ZCT21, ZCD29, ZCP29, ZCD31, ZCP31, ZCD39, ZCP39, ZCD2•M12, ZCP2•M12.



# Limit Switches

## Osiswitch® Compact, Metal and Plastic

### Universal, XCKD, XCKP, and XCKT—Modular

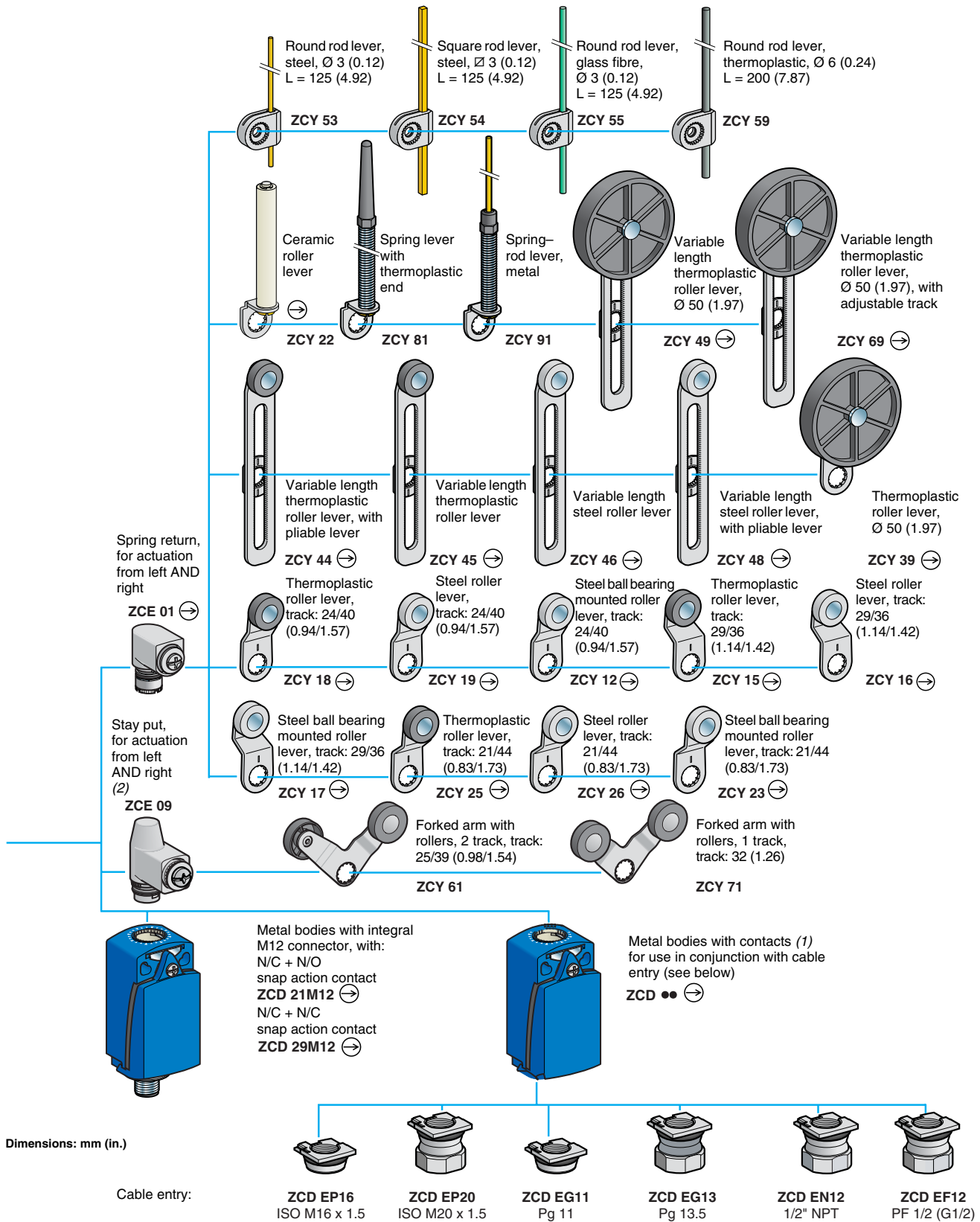

# Limit Switches

## Osiswitch® Compact, Metal and Plastic

### Universal, XCKD, XCKP, and XCKT—Modular

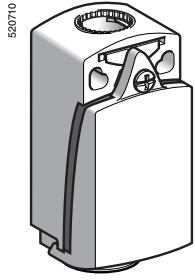

ZCD \*\*

Limit Switches

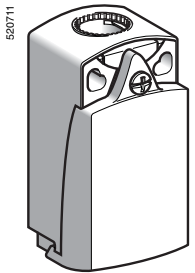

ZCP\*\*

#### Bodies with contacts, types XCK D and XCK P<sup>(1)</sup>

Type of contact	Positive operation (2)	Function diagram	Body material	Catalog Number	Weight kg (lb)
<b>2-pole</b>					
N/C + N/O snap action (XE2SP2151)	⊖		Metal	ZCD 21	0.140 (0.309)
			Plastic	ZCP 21	0.070 (0.154)
N/C + N/C snap action (XE2SP2141)	⊖		Metal	ZCD 29	0.140 (0.309)
			Plastic	ZCP 29	0.070 (0.154)
N/C + N/O break before make, slow break (XE2NP2151)	⊖		Metal	ZCD 25	0.140 (0.309)
			Plastic	ZCP 25	0.070 (0.154)
N/O + N/C make before break, slow break (XE2NP2161)	⊖		Metal	ZCD 26	0.140 (0.309)
			Plastic	ZCP 26	0.070 (0.154)
N/C + N/C simultaneous, slow break (XE2NP2141)	⊖		Metal	ZCD 27	0.140 (0.309)
			Plastic	ZCP 27	0.070 (0.154)
N/O + N/O simultaneous, slow break (XE2NP2131)	-		Metal	ZCD 28	0.140 (0.309)
			Plastic	ZCP 28	0.070 (0.154)
<b>3-pole</b>					
N/C + N/O + N/O snap action (XE3SP2151)	⊖		Metal	ZCD 31	0.140 (0.309)
			Plastic	ZCP 31	0.070 (0.154)
N/C + N/C + N/O snap action (XE3SP2141)	⊖		Metal	ZCD 39	0.140 (0.309)
			Plastic	ZCP 39	0.070 (0.154)
N/C + N/C + N/O break before make, slow break (XE3NP2141)	⊖		Metal	ZCD 37	0.140 (0.309)
			Plastic	ZCP 37	0.070 (0.154)
N/C + N/O + N/O break before make, slow break (XE3NP2151)	⊖		Metal	ZCD 35	0.140 (0.309)
			Plastic	ZCP 35	0.070 (0.154)

1. Bodies with gold contacts or eyelet type connections: please consult your local sales office.  
 2. ⊖ : bodies with contacts assuring positive opening operation, when properly mounted and using a conforming operator.

# Limit Switches

## Osiswitch® Compact, Metal and Plastic

### Universal, XCKD, XCKP, and XCKT—Modular

561390

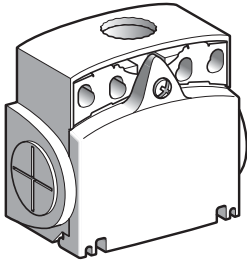

ZCT\*\*\*

561397

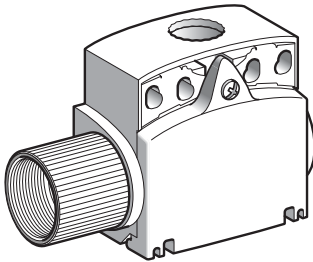

ZCT\*\*N12

#### Bodies with contacts, type XCKT plastic, 2 cable entries

Type of contact	Positive operation (1)	Function diagram	Cable entries	Catalog Number	Weight kg (lb)
<b>2-pole</b>					
N/C + N/O snap action (XE2SP3151)	⊕		ISO M16 x 1.5	ZCT 21P16	0.085 (0.187)
			PG 11	ZCT 21G11	0.085 (0.187)
N/C + N/O break before make, slow break (XE2NP3151)	⊕		ISO M16 x 1.5	ZCT 25P16	0.085 (0.187)
			PG 11	ZCT 25G11	0.085 (0.187)
N/C + N/C simultaneous, slow break (XE2NP3141)	⊕		ISO M16 x 1.5	ZCT 27P16	0.085 (0.187)
			PG 11	ZCT 27G11	0.085 (0.187)
N/O + N/O simultaneous, slow break (XE2NP3131)	—		ISO M16 x 1.5	ZCT 28P16	0.085 (0.187)
			PG 11	ZCT 28G11	0.085 (0.187)
N/O + N/C make before break, slow break (XE2NP3161)	⊕		ISO M16 x 1.5	ZCT 26P16	0.085 (0.187)
			PG 11	ZCT 26G11	0.085 (0.187)

#### Bodies with contacts, type XCKT, plastic, 2 cable entries with 1/2" NPT adapter

Type of contact	Positive operation (1)	Function diagram	Catalog Number	Weight kg (lb)
<b>2-pole</b>				
N/C + N/O snap action (XE2SP3151)	⊕		ZCT 21N12	0.130 (0.287)
N/C + N/O break before make, slow break (XE2NP3151)	⊕		ZCT 25N12	0.130 (0.287)
N/C + N/C simultaneous, slow break (XE2N P3141)	⊕		ZCT 27N12	0.130 (0.287)
N/O + N/O simultaneous, slow break (XE2NP3131)	—		ZCT 28N12	0.130 (0.287)
N/O + N/C make before break, slow break (XE2NP3161)	⊕		ZCT 26N12	0.130 (0.287)

1. ⊕ : bodies with contact assuring positive opening operation, when properly mounted and using a conforming operator.

# Limit Switches

## Osswitch<sup>®</sup> Compact, Metal and Plastic

### Universal, XCKD, XCKP, and XCKT—Modular

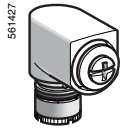

ZCE05



DE9RA1012

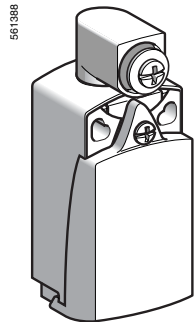

XCK\*2\*01\*\*

Limit Switches

Accessories					
Description	Suitable levers for use with head	Unit catalog number		Weight kg (oz)	
Rotary head, without lever, spring return, for actuation from left AND right or left OR right (1)	ZCY12, ZCY15, ZCY16, ZCY17, ZCY18, ZCY19, ZCY22, ZCY23, ZCY25, ZCY26, ZCY39, ZCY53, ZCY54, ZCY55, ZCY81	ZCE05		0.045 (1.59)	
Tap-off terminal (for XCKT)	Sold in lots of 10	XALZ09		0.010 (0.35)	
Spacer for angular positioning of heads with adjustable levers, for values other than -90°, 0° and 90°	—	XCMZ07		0.002 (0.07)	
Adapter for 1/2" NPT conduit Converts PG 11 conduit entries to 1/2" NPT	Sold in lots of 10	DE9RA1012		0.050 (1.76)	
Bodies with contacts, type XCKP plastic, with rotary head (without operating lever)					
Type of contact	Function diagram	Positive operation (2)	Cable entry	Catalog Number	Weight kg (lb)
<b>2-pole</b>					
N/C + N/O snap action (XE2SP2151)		⊖	1/2" NPT	XCKP2101N12	0.115 (0.254)
		⊕	PG 11	XCKP2101G11	0.115 (0.254)
		⊕	M12 connector	XCKP2101M12	0.125 (0.276)
N/C + N/O break before make, slow break (XE2NP2151)		⊖	1/2" NPT	XCKP2501N12	0.115 (0.254)
		⊕	PG 11	XCKP2501G11	0.115 (0.254)
Bodies with contacts, type XCKD metal, with rotary head (without operating lever)					
Type of contact	Function diagram	Positive operation (2)	Cable entry	Catalog Number	Weight kg (lb)
<b>2-pole</b>					
N/C + N/O snap action (XE2SP2151)		⊖	1/2" NPT	XCKD2101N12	0.185 (0.408)
		⊕	PG 11	XCKD2101G11	0.185 (0.408)
		⊕	M12 connector	XCKD2101M12	0.195 (0.430)
N/C + N/O break before make, slow break (XE2NP2151)		⊖	1/2" NPT	XCKD2501N12	0.185 (0.408)
		⊕	PG 11	XCKD2501G11	0.185 (0.408)

# Limit Switches

## Osiswitch® Compact, Metal and Plastic

### Universal, XCKD, XCKP, and XCKT—Modular

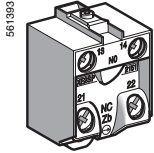

XE2\*\*21\*\*

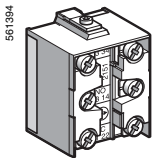

XE3\*\*21\*\*





Contact blocks with screw clamp terminals for XCKD and XCKP				
Type of contact	Positive operation (1)	Function diagram	Catalog number for standard contacts	Weight kg (lb)
<b>2-pole</b>				
N/C + N/O snap action	⊕		XE2SP2151	0.020 (0.044)
N/C + N/C simultaneous, snap action	⊕		XE2SP2141	0.020 (0.044)
N/C + N/O break before make, slow break	⊕		XE2NP2151	0.020 (0.044)
N/O + N/C make before break, slow break	⊕		XE2NP2161	0.020 (0.044)
N/C + N/C simultaneous, slow break	⊕		XE2NP2141	0.020 (0.044)
N/O + N/O simultaneous, slow break	—		XE2NP2131	0.020 (0.044)
<b>3-pole</b>				
N/C + N/O + N/O snap action	⊕		XE3SP2151	0.035 (0.077)
N/C + N/C + N/O snap action	⊕		XE3SP2141	0.035 (0.077)
N/C + N/C + N/O break before make, slow break	⊕		XE3NP2141	0.035 (0.077)
N/C + N/O + N/O break before make, slow break	⊕		XE3NP2151	0.035 (0.077)
<b>Contact blocks with screw clamp terminals for XCKT</b>				
Type of contact	Positive operation (1)	Function diagram	Catalog number for standard contacts	Weight kg (lb)
<b>2-pole</b>				
N/C + N/O snap action	⊕		XE2SP3151	0.015 (0.033)
N/C + N/O break before make, slow break	⊕		XE2NP3151	0.015 (0.033)
N/O + N/C make before break, slow break	⊕		XE2NP3161	0.015 (0.033)
N/C + N/C simultaneous, slow break	⊕		XE2NP3141	0.015 (0.033)
N/O + N/O simultaneous, slow break	—		XE2NP3131	0.015 (0.033)

1. ⊕: contact blocks assuring positive opening operation, when properly mounted and using a conforming operator.

# Limit Switches

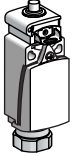
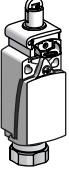
## Osiswitch® Compact with Manual Reset

Application, XCDR—Complete Switches, Metal, with One Cable Entry, 1/2" NPT



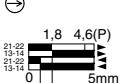
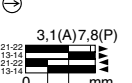
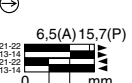
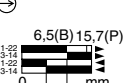
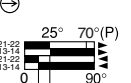
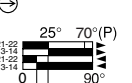
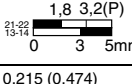
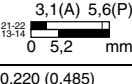
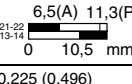
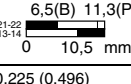
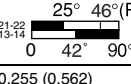
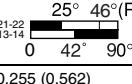



Type of head	Plunger (mounting by the body)				Rotary (mounting by the body)	
						
Type of operator	Metal end plunger	Steel roller plunger	Thermoplastic roller lever plunger, horizontal actuation in 1 direction	Thermoplastic roller lever plunger, vertical actuation in 1 direction	Thermoplastic roller lever	Steel roller lever

Catalog numbers of complete switches with one 1/2" NPT cable entry						
 <p>2-pole N/C + N/O snap action (XE2SP2151)</p>	XCDR2110N12 	XCDR2102N12 	XCDR2121N12 	XCDR2127N12 	XCDR2118N12 	XCDR2119N12 
	XCDR2510N12 	XCDR2502N12 	XCDR2521N12 	XCDR2527N12 	XCDR2518N12 	XCDR2519N12 
Weight, kg (lb)	0.215 (0.474)	0.220 (0.485)	0.225 (0.496)	0.225 (0.496)	0.255 (0.562)	0.255 (0.562)

Catalog numbers of complete switches with one PG 13.5 cable entry						
For complete switches with 1 PG 13.5 cable entry, replace N12 with G13. Example: XCDR 2110P20 becomes XCDR 2110G13.						

Catalog numbers of complete switches with one P20 cable entry						
For complete switches with 1 ISO M20 x 1.5 cable entry, replace N12 with P20. Example: XCDR 2110N12 becomes XCDR 2110P20.						

<b>Contact operation</b>	 contact closed	(A) (B) = cam displacement	 N/C contact with positive opening operation, when properly mounted and using a conforming operator
	 contact open	(P) = positive opening point	

Characteristics						
<b>Switch actuation</b>	On end	By 30° cam				
<b>Type of actuation</b>						
<b>Maximum actuation speed</b>	0.5 m/s (1.64 ft/s)		1 m/s (3.28 ft/s)		1.5 m/s (4.92 ft/s)	
<b>Minimum force or torque</b>	For tripping	15 N (3.37 lb)	12 N (2.70 lb)	6 N (1.35 lb)	0.1 N•m (0.89 lb-in)	
	For positive opening	45 N (10.12 lb)	36 N (8.09 lb)	18 N (4.05 lb)	0.25 N•m (2.21 lb-in)	
<b>Cable entry</b>	1 entry tapped M20 x 1.5 mm for ISO cable entry, clamping capacity 7 to 13 mm (0.28 to 0.51 in.), or 1 entry tapped PG 13.5, clamping capacity 9 to 12 mm (0.35 to 0.47 in.), or 1 entry tapped for 1/2" NPT (USAS B2-1) conduit					

# Limit Switches

## Osiswitch® Compact with Manual Reset

Application, XCDR—Complete Switches, Metal, with One Cable Entry, 1/2" NPT

### Dimensions

XCDR2•10\*\*\*

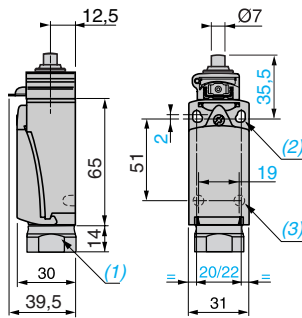

XCDR2•02\*\*\*

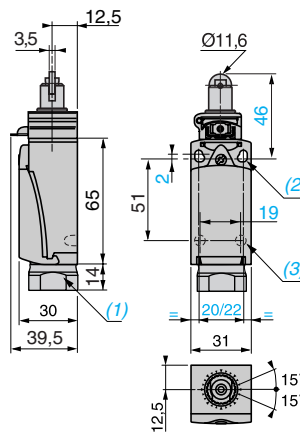

XCDR2•21\*\*\*

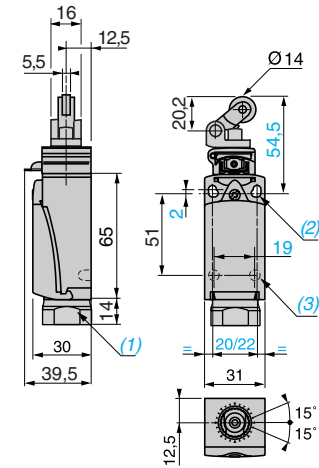

1. Tapped entry for ISO M20 x 1.5 or PG 13.5 conduit thread or 1/2" NPT conduit
2. 2 elongated holes  $\varnothing 4.3 \times 6.3$  mm (0.17 x 0.25 in.) on 22 mm (0.87 in.) centers, 2 holes  $\varnothing 4.3$  mm (0.17 in.) on 20 mm (0.79 in.) centers
3. 2 x  $\varnothing 3$  holes for support studs, depth 4 mm (0.16 in.)

### Dimensions

XCDR2•27\*\*\*

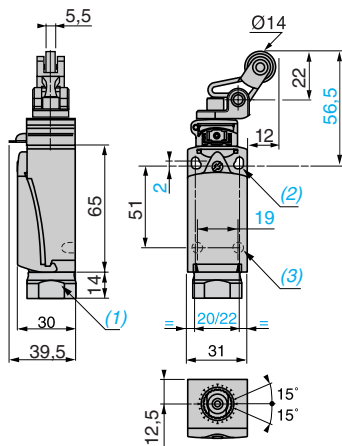

XCDR2•18\*\*\*, XCDR2•19\*\*\*

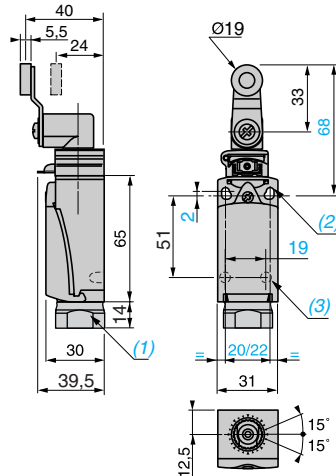

1. Tapped entry for ISO M20 x 1.5 or PG 13.5 conduit thread or 1/2" NPT conduit.
2. 2 elongated holes  $\varnothing 4.3 \times 6.3$  mm (0.17 x 0.25 in.) on 22 mm (0.87 in.) centers, 2 holes  $\varnothing 4.3$  mm (0.17 in.) on 20 mm (0.79 in.) centers.
3. 2 x  $\varnothing 3$  holes for support studs, depth 4 mm (0.16 in.).

# Limit Switches

## Osiswitch® Compact with Manual Reset

Application, XCPR—Complete Switches, Plastic, with One Cable Entry, 1/2" NPT

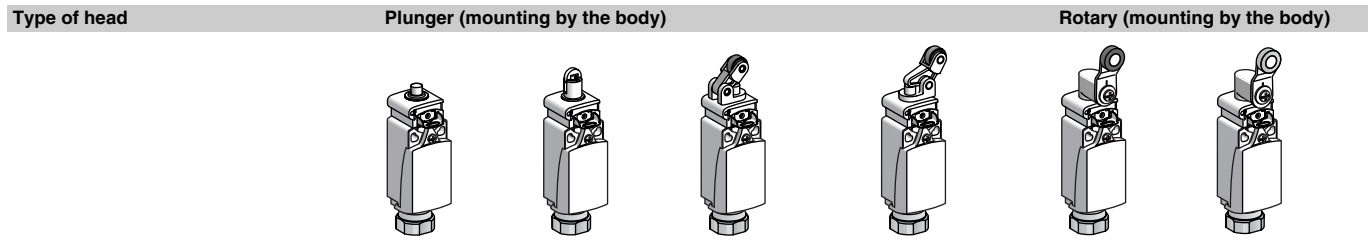

Type of head	Plunger (mounting by the body)			Rotary (mounting by the body)		
Type of operator	Metal end plunger	Steel roller plunger	Thermoplastic roller lever plunger, horizontal actuation in 1 direction	Thermoplastic roller lever plunger, vertical actuation in 1 direction	Thermoplastic roller lever	Steel roller lever

### Catalog numbers of complete switches with one 1/2" NPT cable entry

<p>2-pole N/C + N/O snap action (XE2SP2151)</p>	<p><b>XCPR2110N12</b></p>	<p><b>XCPR2102N12</b></p>	<p><b>XCPR2121N12</b></p>	<p><b>XCPR2127N12</b></p>	<p><b>XCPR2118N12</b></p>	<p><b>XCPR2119N12</b></p>
<p>2-pole N/C + N/O break before make, slow break (XE2NP2151)</p>	<p><b>XCPR2510N12</b></p>	<p><b>XCPR2502N12</b></p>	<p><b>XCPR2521N12</b></p>	<p><b>XCPR2527N12</b></p>	<p><b>XCPR2518N12</b></p>	<p><b>XCPR2519N12</b></p>
<p>2-pole N/C + N/C snap action (XE2S P2141)</p>	<p><b>XCPR2910N12</b></p>	<p><b>XCPR2902N12</b></p>	<p><b>XCPR2921N12</b></p>	<p><b>XCPR2927N12</b></p>	<p><b>XCPR2918N12</b></p>	—
Weight, kg (lb)	0.115 (0.254)	0.115 (0.254)	0.125 (0.276)	0.120 (0.265)	0.155 (0.342)	—

### Catalog numbers of complete switches with one PG 13.5 cable entry

For complete switches with one PG 13.5 cable entry, replace N12 with G13.  
Example: XCPR 2110P20 becomes **XCPR 2110G13**.

### Catalog numbers of complete switches with one P20 cable entry

For complete switches with one ISO M20 x 1.5 cable entry, replace N12 with P20.  
Example: XCPR 2110N12 becomes **XCPR 2110P20**.

<b>Contact operation</b> 		(A) (B) = cam displacement (P) = positive opening point	
------------------------------	--	--	--

### Characteristics

Switch actuation	On end	By 30° cam			
Type of actuation					
Maximum actuation speed	0.5 m/s (1.64 ft/s)	1 m/s (3.28 ft/s)			1.5 m/s (4.92 ft/s)
Minimum force or torque	For tripping	15 N (3.37 lb)	12 N (2.70 lb)	6 N (1.35 lb)	0.1 N•m (0.89 lb-in)
	For positive opening	45 N (10.12 lb)	36 N (8.09 lb)	18 N (4.05 lb)	0.25 N•m (2.21 lb-in)
Cable entry	1 entry tapped M20 x 1.5 mm for ISO cable entry, clamping capacity 7 to 13 mm (0.28 to 0.51 in.), or 1 entry tapped PG 13.5, clamping capacity 9 to 12 mm (0.35 to 0.47 in.), or 1 entry tapped for 1/2" NPT (USAS B2-1) conduit				

### Other versions

Complete switches with cable entries other than those listed above.  
Consult your local sales office.



# Limit Switches

## Osiswitch® Compact with Manual Reset

Application, XCPR—Complete Switches, Plastic, with One Cable Entry, 1/2" NPT

### Dimensions

XCPR2•10\*\*\*

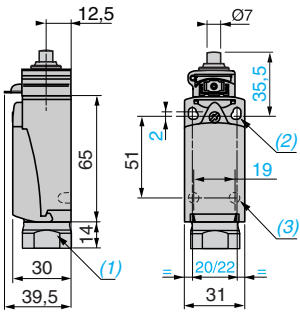

XCPR2•02\*\*\*

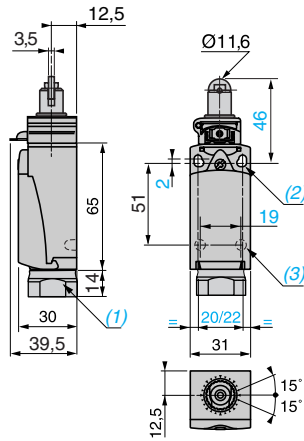

XCPR2•21\*\*\*

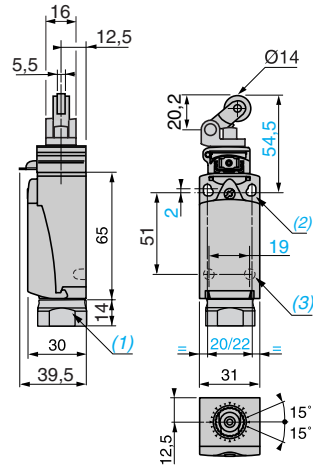

1. Tapped entry for ISO M20 x 1.5 or PG 13.5 conduit thread or 1/2" NPT conduit.
2. 2 elongated holes  $\varnothing 4.3 \times 6.3$  mm (0.17 x 0.25 in.) on 22 mm (0.87 in.) centers, 2 holes  $\varnothing 4.3$  mm (0.17 in.) on 20 mm (0.79 in.) centers.
3. 2 x  $\varnothing 3$  holes for support studs, depth 4 mm (0.16 in.).

### Dimensions

XCPR2•27\*\*\*

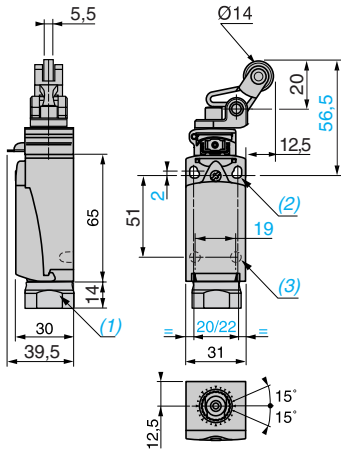

XCPR2•18\*\*\*, XCPR2•19\*\*\*

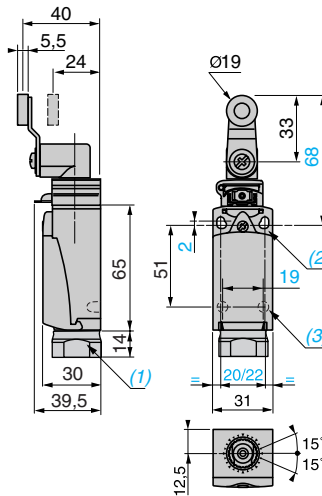

1. Tapped entry for ISO M20 x 1.5 or PG 13.5 conduit thread or 1/2" NPT conduit.
2. 2 elongated holes  $\varnothing 4.3 \times 6.3$  mm (0.17 x 0.25 in.) on 22 mm (0.87 in.) centers, 2 holes  $\varnothing 4.3$  mm (0.17 in.) on 20 mm (0.79 in.) centers.
3. 2 x  $\varnothing 3$  holes for support studs, depth 4 mm (0.16 in.).

# Limit Switches

## Osiswitch® Compact with Manual Reset

### Application, XCTR—Complete Switches, Plastic, with Two Cable Entries, 1/2" NPT

Type of head Plunger (mounting by the body)

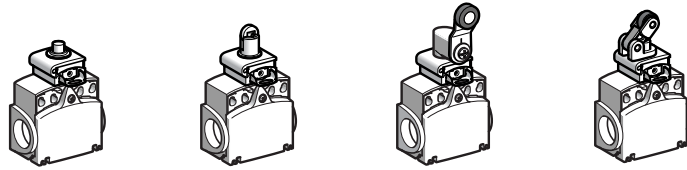

Type of operator	Metal end plunger	Steel roller plunger	Thermoplastic roller lever plunger	Thermoplastic roller lever plunger, horizontal actuation in 1 direction
------------------	-------------------	----------------------	------------------------------------	---

#### Catalog numbers of complete switches with two cable entries, 1/2" NPT (1)

<p>2-pole N/C + N/O snap action (XE2SP3151)</p>	<b>XCTR2110N12</b> ⊕ 	<b>XCTR2102N12</b> ⊕ 	<b>XCTR2118N12</b> ⊕ 	<b>XCTR2121N12</b> ⊕ 
	<b>XCTR2510N12</b> ⊕ 	<b>XCTR2502N12</b> ⊕ 	<b>XCTR2518N12</b> ⊕ 	<b>XCTR2521N12</b> ⊕ 
<p>2-pole N/C + N/O break before make, slow break (XE2NP3151)</p>	<b>XCTR2110N12</b> ⊕ 	<b>XCTR2102N12</b> ⊕ 	<b>XCTR2118N12</b> ⊕ 	<b>XCTR2121N12</b> ⊕ 
<b>Weight, kg (lb)</b>	0.120 (0.265)	0.125 (0.276)	0.165 (0.364)	0.135 (0.298)

1. One PG 11 to 1/2" NPT adapter and one plug included.

#### Catalog numbers of complete switches with two PG 11 cable entries

For complete switches with two PG 11 cable entries, replace N12 with G11.  
 Example: XCTR 2110N12 becomes **XCTR 2110G11**.

#### Catalog numbers of complete switches with two ISO M16 x 1.5 cable entries

For complete switches with two ISO M16 x 1.5 cable entries, replace N12 with P16.  
 Example: XCTR 2110N12 becomes **XCTR 2110P16**.

<b>Weight, kg (lb)</b>	0.120 (0.265)	0.125 (0.276)	0.165 (0.364)	0.135 (0.298)
<b>Contact operation</b>	<p>(A) = cam displacement                  (P) = positive opening point                  ⊕ N/C contact with positive opening operation, when properly mounted and using a conforming operator</p>			

#### Characteristics

<b>Switch actuation</b>	On end	By 30° cam		
<b>Type of actuation</b>				
<b>Maximum actuation speed</b>	0.5 m/s (1.64 ft/s)		1.5 m/s (4.92 ft/s)	1 m/s (3.28 ft/s)
<b>Minimum force or torque</b>	For tripping	15 N (3.37 lb)	12 N (2.70 lb)	0.1 N•m (0.89 lb-in)
	For positive opening	45 N (10.12 lb)	36 N (8.09 lb)	0.25 N•m (2.21 lb-in)
<b>Cable entry (1 entry fitted with blanking plug)</b>	2 entries tapped M16 x 1.5 mm for ISO cable entry, clamping capacity 4 to 8 mm (0.16 to 0.31 in.), or 2 entries tapped PG 11, clamping capacity 7 to 10 mm (0.28 to 0.39 in.), or 2 entries tapped for 1/2" NPT (USAS B2-1) conduit using PG 11 to 1/2" NPT adapter DE9RA1012 (1 entry fitted with adapter)			

Limit Switches

# Limit Switches

## Osiswitch® Compact, Metal with Manual Reset

Application, XCDR—Complete Switches with Two Cable Entries, 1/2" NPT

### Dimensions

#### XCTR 2•18\*\*\*

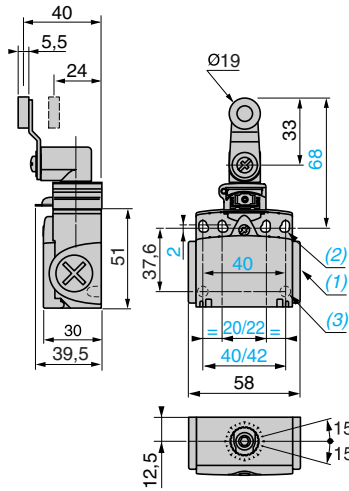

#### XCTR 2•21\*\*\*

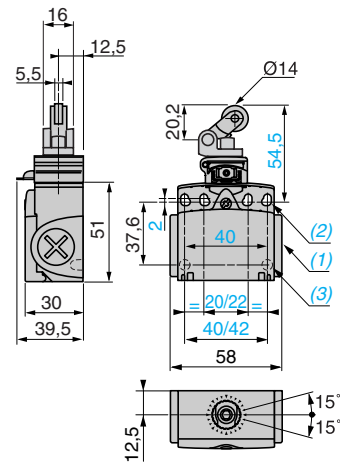

1. Tapped entry for ISO M16 x 1.5 or PG 11 conduit thread. 1/2" NPT adapter included.
2. 4 elongated holes  $\varnothing$  4.3 x 6.3 mm (0.17 x 0.25 in.) on 22/42 mm (0.87/1.65 in.) centers, 4 holes  $\varnothing$  4.3 mm (0.17 in.) on 20/40 mm (0.79/1.57 in.) centers.
3. 2 x  $\varnothing$  3 holes for support studs, depth 4 mm (0.16 in.).

#### XCTR 2•10\*\*\*

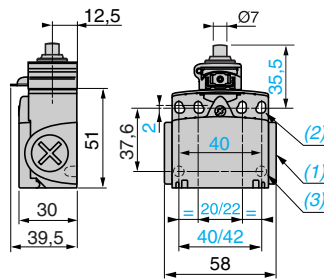

#### XCTR 2•02\*\*\*

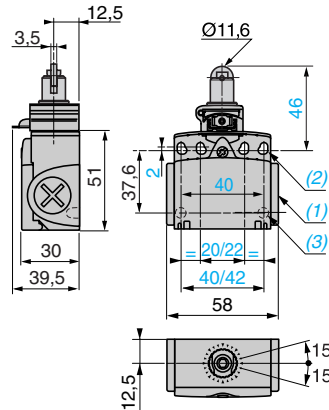

#### DE9RA1012

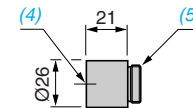

1. Tapped entry for ISO M16 x 1.5 or PG 11 conduit thread. 1/2" NPT adapter included.
2. 4 elongated holes  $\varnothing$  4.3 x 6.3 mm (0.17 x 0.25 in.) on 22/42 mm (0.87/1.65 in.) centers, 4 holes  $\varnothing$  4.3 mm (0.17 in.) on 20/40 mm (0.79/1.57 in.) centers.
3. 2 x  $\varnothing$  3 holes for support studs, depth 4 mm (0.16 in.).
4. Tapped entry for 1/2" NPT conduit.
5. PG 11 threaded sleeve.

# Limit Switches

## Osiswitch® Classic, Metal

### XCKM, XCKL, and XCKML

■ **XCKM**  
with 3 cable entries

□ With plunger head

561643

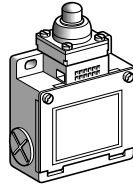

561644

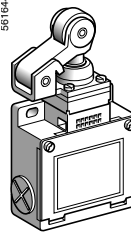

□ With rotary or multi-directional head

808148

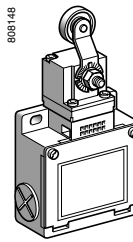

561645

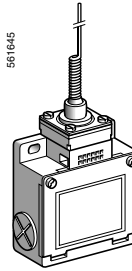

Page 82

■ **XCKL**  
with 1 cable entry

□ With plunger head

808140

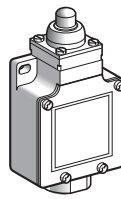

808145

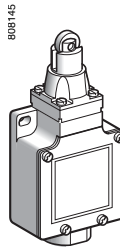

□ With rotary or multi-directional head

808141

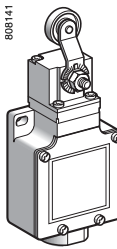

808147

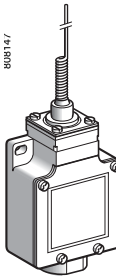

Page 84

■ **XCKML**  
with 3 cable entries and two 2-pole contacts

□ With plunger head

561639

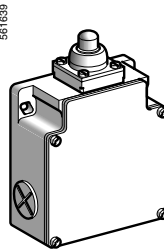

561640

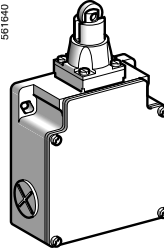

□ With rotary or multi-directional head

561641

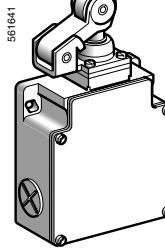

561642

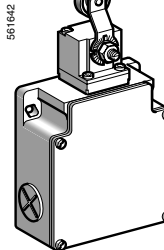

Page 94

### Environment characteristics

<b>Conforming to standards</b>	Products	IEC 60947-5-1, EN 60947-5-1, UL 508, CSA C22-2 n° 14
	Machine assemblies	IEC 60204-1, EN 60204-1
<b>Product certifications</b>		UL, CSA, CCC (for XCKM)
<b>Protective treatment</b>	Version	Standard "TC". Special "TH"
<b>Ambient air temperature</b>	For operation	- 25...+70 °C (-13...+158 °F)
	For storage	- 40...+70 °C (-40...+158 °F)
<b>Vibration resistance</b>	Conforming to IEC 60068-2-6	25 gn (10...500 Hz)
<b>Shock resistance</b>	Conforming to IEC 60068-2-27	50 gn (11 ms)
<b>Electric shock protection</b>		Class I conforming to IEC 61140 and NF C 20-030
<b>Degree of protection</b>		IP 66 conforming to IEC 60529; IK 05 conforming to EN 50102
<b>Repeat accuracy</b>		XCKML 0.1 mm; XCKM and XCKL 0.05 mm on the tripping points, with 1 million operating cycles for head with end plunger
<b>Cable entry or integral connector</b>	Depending on model	XCKM: 3 tapped entries, PG 11 conduit thread (1/2" NPT adapter available), or tapped M20 XCKL: 1 tapped entry incorporating 1/2" NPT adapter XCKML: 3 tapped entries, PG 13 conduit thread (1/2" NPT adapter included), or tapped M20
<b>Materials</b>		Bodies: Zamak® zinc alloy Rotary heads: Zamak® zinc alloy or plastic depending on model; other heads: plastic

# Limit Switches

## Osiswitch® Classic, Metal

### XCKM, XCKL, and XCKML

#### Contact block characteristics

Rated operational characteristics	XE2•P	$\sim$ AC-15; A300 ( $U_e = 240$ V, $I_e = 3$ A); $I_{the} = 10$ A $\equiv$ DC-13; Q300 ( $U_e = 250$ V, $I_e = 0,27$ A), conforming to IEC 60947-5-1 Appendix A, EN 60947-5-1
	XE3•P	$\sim$ AC-15; B300 ( $U_e = 240$ V, $I_e = 1,5$ A); $I_{the} = 6$ A $\equiv$ DC-13; R300 ( $U_e = 250$ V, $I_e = 0,1$ A), conforming to IEC 60947-5-1 Appendix A, EN 60947-5-1
Rated insulation voltage	XE2•P	$U_i = 500$ V degree of pollution 3 conforming to IEC 60947-1 $U_i = 300$ V conforming to UL 508, CSA C22-2 n° 14
	XE3•P	$U_i = 400$ V degree of pollution 3 conforming to IEC 60947-1 $U_i = 300$ V conforming to UL 508, CSA C22-2 n° 14
Rated impulse withstand voltage	XE2•P	$U_{imp} = 6$ kV conforming to IEC 60947-1, IEC 60664
	XE3•P	$U_{imp} = 4$ kV conforming to IEC 60947-1, IEC 60664
Positive operation (depending on model)		N/C contacts with positive opening operation conforming to IEC 947-5-1 Section 3, EN 60 947-5-1
Resistance across terminals		$\leq 25$ m $\Omega$ conforming to IEC 60255-7 category 3
Short-circuit protection	XE2•P	10 A cartridge fuse type gG (gl)
	XE3•P	6 A cartridge fuse type gG (gl)
Cabling (screw and captive cable clamp terminals)	XE2SP21•1	Clamping capacity, min: $1 \times 0,34$ mm <sup>2</sup> , max: $2 \times 1,5$ mm <sup>2</sup>
	XE2NP21•1	Clamping capacity, min: $1 \times 0,5$ mm <sup>2</sup> , max: $2 \times 2,5$ mm <sup>2</sup>
	XESP2151L and XENP2151L	Clamping capacity, min: $1 \times 0,34$ mm <sup>2</sup> , max: $2 \times 1,5$ mm <sup>2</sup> or $1 \times 2,5$ mm <sup>2</sup>
	XE3NP et XE3SP	Clamping capacity, min: $1 \times 0,34$ mm <sup>2</sup> , max: $1 \times 1$ mm <sup>2</sup> or $2 \times 0,75$ mm <sup>2</sup>
Minimum actuation speed		<b>XE2SP21•1, XESP2151L and XE3SP:</b> 0.01 m/minute (0.03 ft/minute) <b>XE2NP21•1, XENP2151L and XE3NP:</b> 6 m/minute (19.68 ft/minute)
Electrical durability		<ul style="list-style-type: none"> <li>Conforming to IEC 60947-5-1 appendix C</li> <li>Utilization categories AC-15 and DC-13</li> <li>Maximum operating rate: 3600 operating cycles/hour</li> <li>Load factor: 0,5</li> </ul>

#### XE2SP21•1, XE2SP2141, XESP2151L

#### XE2NP21•1, XENP2151L

a.c. supply  
 $\sim$  50/60 Hz  
 $\square$  inductive circuit

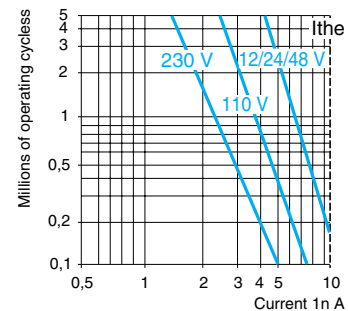
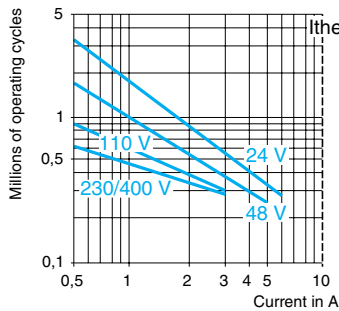

d.c. supply  $\equiv$

#### Power switched in W for 5 million operating cycles

Voltage	V	24	48	120
$\square$	W	10	7	4

For XE2SP•151 on  $\sim$  or  $\equiv$ , the "N/C" and "N/O" contacts are simultaneously loaded to the values shown with reverse polarity.

#### Power switched in W for 5 million operating cycles

Voltage	V	24	48	120
$\square$	W	13	9	7

#### XE3SP••••

#### XE3NP••••

a.c. supply  
 $\sim$  50/60 Hz  
 $\square$  inductive circuit

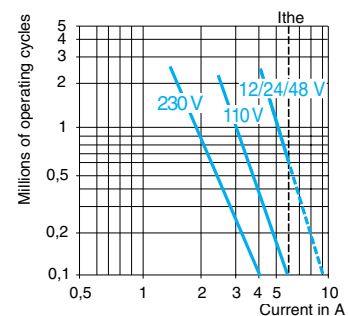
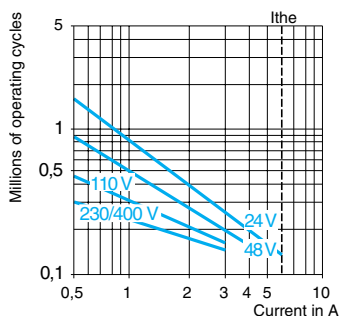

d.c. supply  $\equiv$

#### Power switched in W for 5 million operating cycles

Voltage	V	24	48	120
$\square$	W	3	2	1











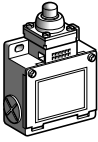
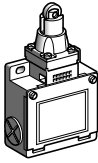
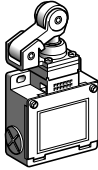
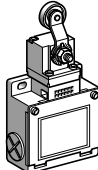
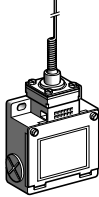
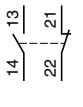
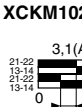
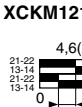
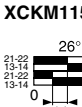
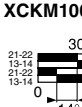
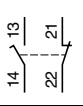
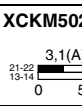
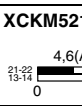
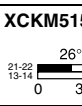
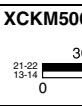
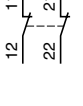
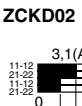

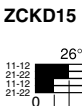
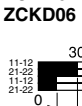
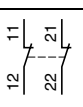
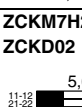
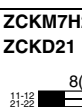
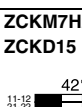

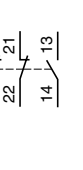

#### Power switched in W for 5 million operating cycles

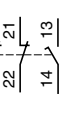
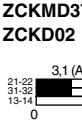
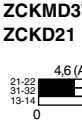
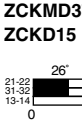
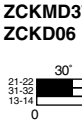
Voltage	V	24	48	120
$\square$	W	4	3	2

# Limit Switches

## Osiswitch® Classic, Metal

### XCKM—Complete Switches w/ 3 ISO M20x1.5 Cable Entries, Including One 1/2" NPT Adapter

Type of head	Plunger (mounting by the body)			Rotary (mounting by the body)	Multi-directional (mounting by the body)
					
Type of operator	Metal end plunger	Steel roller plunger	Thermoplastic roller lever plunger, horizontal actuation in 1 direction	Thermoplastic roller lever (1)	Cat's whisker (4)
<b>Catalog numbers (2) (3)</b>					
2-pole N/C + N/O snap action (XE2SP2151)					
2-pole N/C + N/O break before make, slow break (XE2NP2151)					
2-pole N/C + N/C snap action (XE2SP2141)					
2-pole N/C + N/C simultaneous, slow break (XE2NP2141)					
3-pole N/C + N/C + N/O snap action (XE3SP2141)					
3-pole N/C + N/C + N/O break before make, slow break (XE3NP2141)					
Weight, kg (lb)	0.250 (0.551)	0.255 (0.562)	0.300 (0.661)	0.280 (0.617)	0.250 (0.551)
Contact operation	 contact closed  contact open	(A) = cam displacement (P) = positive opening point	 N/C contact with positive opening operation, when properly mounted and using a conforming operator		
<b>Characteristics</b>					
Switch actuation	On end	By 30° cam			By any moving part
Type of actuation					
Maximum actuation speed	0.5 m/s (1.64 ft/s)		1.5 m/s (4.92 ft/s)		1 m/s (3.28 ft/s), any direction
Minimum force or torque	For tripping	15 N (3.37 lb)	12 N (2.70 lb)	8 N (1.80 lb)	0.1 N•m (0.89 lb-in)
	For positive opening	45 N (10.12 lb)	36 N (8.09 lb)	24 N (5.40 lb)	0.25 N•m (2.21 lb-in)
Cable entry (3)	3 entries tapped M20 x 1.5 mm for ISO cable entry, clamping capacity 7 to 13 mm (0.28 to 0.51 in.)				

- Adjustable throughout 360° in 5° steps, or in 90° steps by reversing the notched washer.
  - Switches with gold contacts or eyelet type connections: please consult your local sales office.
  - For an entry tapped for a PG 11 conduit thread, delete H29 from the end of the catalog number. Example: XCKM110H29 becomes XCKM110.
  - Value taken with actuation by moving part at 100 mm (3.94 in.) from the mounting.
- Note: To convert XCKM110 from PG 11 to 1/2" NPT, use adapter DE9RA1012, included.

# Limit Switches

## Osiswitch® Classic, Metal

### XCKM—Complete Switches w/ 3 ISO M20x1.5 Cable Entries, Including One 1/2" NPT Adapter

**XCKM•10**  
ZCKMD3• + ZCKD10

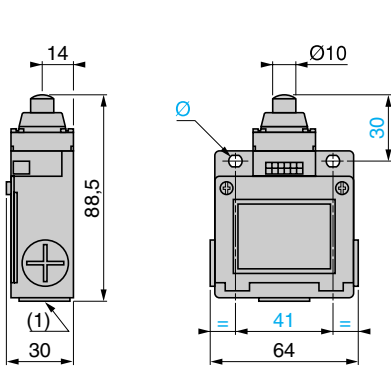

**XCKM•02**  
ZCKMD3• + ZCKD02

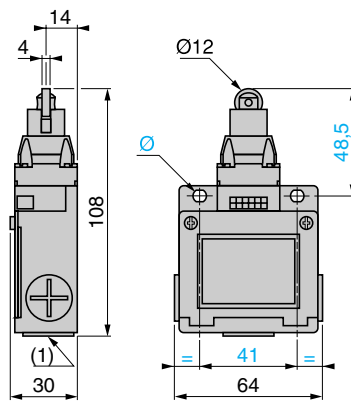

**XCKM•21**  
ZCKMD3• + ZCKD21

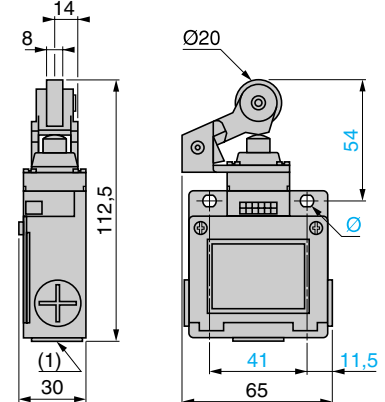

**XCKM•15**  
ZCKMD3• + ZCKD15

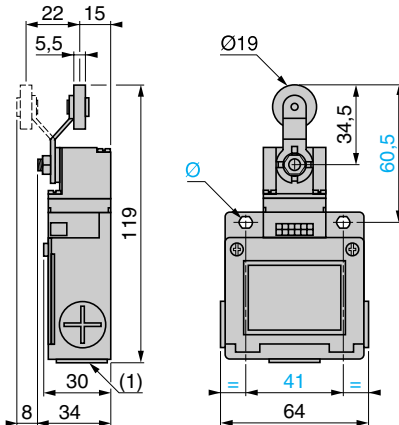

**XCKM•06**  
ZCKMD3• + ZCKD06

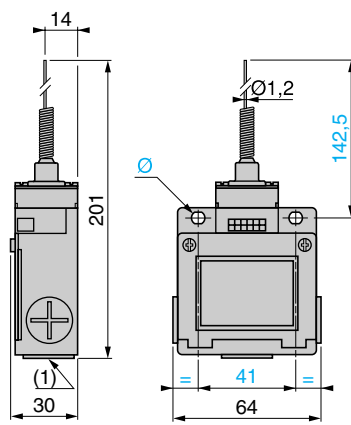

**Rear view**  
XCKM•••, ZCKM•, ZCKMD3•

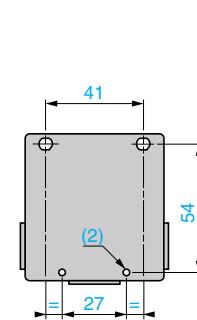

1. 3 tapped entries for ISO M20 x 1.5 or PG 11 conduit thread. Includes 1/2" NPT conduit adapter DE9RA1012.
2. 2 x Ø 4 H 11, depth 10.
- Ø: 2 elongated holes Ø 5.2 x 6.2.

**Adapter for 1/2" NPT conduit**  
DE9RA1012

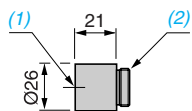











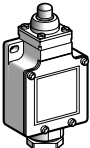
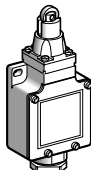
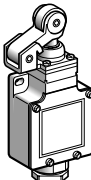
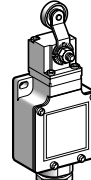
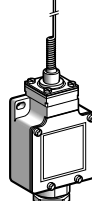









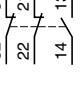
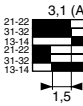
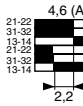
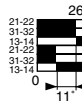
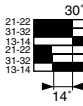







1. Tapped entry for 1/2" NPT conduit.
2. PG 11 threaded sleeve.

Limit Switches

# Limit Switches

## Osiswitch® Classic, Metal

### XCKL—Complete Switches Incorporating Adapter for 1/2" NPT

Type of head	Plunger (mounting by the body)			Rotary (mounting by the body)	Multi-directional (mounting by the body)
					
Type of operator	Metal end plunger	Steel roller plunger	Thermoplastic roller lever plunger, horizontal actuation in 1 direction	Thermoplastic roller lever (1)	Cat's whisker (2)
<b>Catalog numbers (3)</b>					
2-pole N/C + N/O snap action (XE2SP2151)	 XCKL110 ⊖ 1.8 4,5(P) 0,9 5,5mm	 XCKL102 ⊖ 3,1(A) 7,8(P) 1,5 mm	 XCKL121 ⊖ 4,6(A) 11,1(P) 2,2 mm	 XCKL115 ⊖ 26° 58°(P) 11° 70°	 XCKL106 30° 14°
2-pole N/C + N/O break before make, slow break (XE2NP2151)	 XCKL510 ⊕ 1.8 3,2(P) 0 3 5,5mm	 XCKL502 ⊕ 3,1(A) 5,6(P) 0 5,2 mm	 XCKL521 ⊕ 4,6(A) 8(P) 0 7,6 mm	 XCKL515 ⊕ 26° 42°(P) 0 36° 70°	 XCKL506 30° 0 40°
3-pole N/C + N/C + N/O snap action (XE3SP2141)	 ZCKLD39 + ZCKD10 ⊖ 1.8 4,5 (P) mm 0,9 5,5	 ZCKLD39 + ZCKD02 ⊖ 3,1 (A) 7,8 (P) mm 1,5	 ZCKLD39 + ZCKD21 ⊖ 4,6 (A) 11,1 (P) mm 2,2	 ZCKLD39 + ZCKD15 ⊖ 26° 58° (P) 11° 70°	 ZCKLD39 + ZCKD06 30° 14°
2-pole N/C + N/C simultaneous, slow break (XE2NP2141)	 ZCKL7 + ZCKD10 ⊖ 3,2(P) 1,8 5,5mm	 ZCKL7 + ZCKD02 ⊖ 5,6(P) 3,1(A) 9mm	 ZCKL7 + ZCKD21 ⊖ 8(P) 4,6(A) mm	 ZCKL7 + ZCKD15 ⊖ 42°(P) 23° 70°	 ZCKL7 + ZCKD06 30°
3-pole N/C + N/C + N/O break before make, slow break (XE3NP2141)	 ZCKLD37 + ZCKD10 ⊕ 1.8 3,2 (P) mm 0 3 5,5	 ZCKLD37 + ZCKD02 ⊕ 3,1 (A) 3,2 (P) mm 0 5,2 5,5	 ZCKLD37 + ZCKD21 ⊕ 4,6 (A) 8 (P) mm 0 7,6	 ZCKLD37 + ZCKD15 ⊕ 26° 42° (P) 0 36° 70°	 ZCKLD37 + ZCKD06 30° 0 40°
Weight, kg (lb)	0.255 (0.562)	0.260 (0.573)	0.305 (0.672)	0.285 (0.628)	0.255 (0.562)
Contact operation	 contact closed  contact open	(A) = cam displacement (P) = positive opening point		⊕ N/C contact with positive opening operation, when properly mounted and using a conforming operator	
<b>Characteristics</b>					
Switch actuation	On end	By 30° cam			By any moving part
Type of actuation					
Maximum actuation speed	0.5 m/s (1.64 ft/s)		1.5 m/s (4.92 ft/s)		1 m/s (3.28 ft/s), any direction
Minimum force or torque	For tripping For positive opening	15 N (3.37 lb) 45 N (10.12 lb)	12 N (2.70 lb) 36 N (8.09 lb)	8 N (1.80 lb) 24 N (5.40 lb)	0.1 N•m (0.89 lb-in) 0.13 N•m (1.15 lb-in)
Cable entry	1 entry incorporating metal cable entry. Clamping capacity 6 to 13.5 mm (0.24 to 0.53 in.).				

- Adjustable throughout 360° in 5° steps, or in 90° steps by reversing the notched washer.
- Value taken with actuation by moving part at 100 mm (3.94 in.) from the mounting.
- Switches with gold contacts or eyelet type connections: please consult your local sales office.



# Limit Switches

## Osiswitch® Classic, Metal

### XCKL—Complete Switches Incorporating Adapter for 1/2" NPT

**XCKL•10**  
ZCKL• + ZCKD10  
ZCKLD3• + ZCKD10

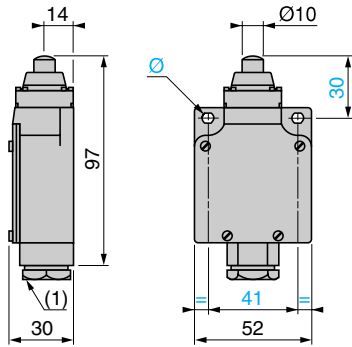

**XCKL•02**  
ZCKL3• + ZCKD02  
ZCKLD3• + ZCKD02

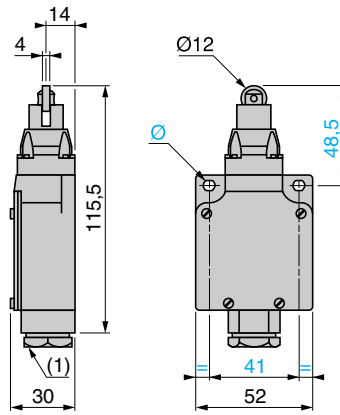

**XCKL•21**  
ZCKL• + ZCKD21  
ZCKLD3• + ZCKD21

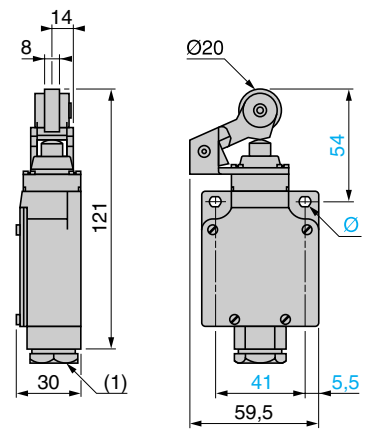

**XCKL•15**  
ZCKL• + ZCKD15  
ZCKLD3• + ZCKD15

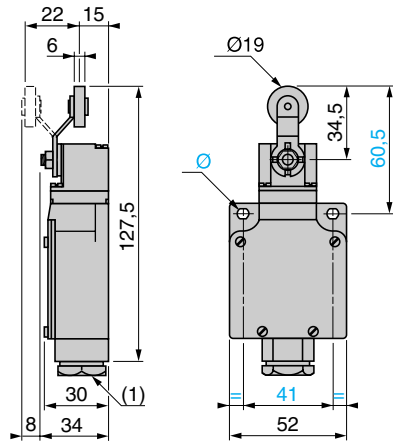

**XCKL•06**  
ZCKL• + ZCKD06  
ZCKLD3• + ZCKD06

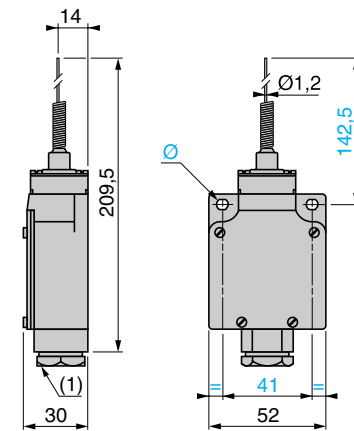

**Body mountings**

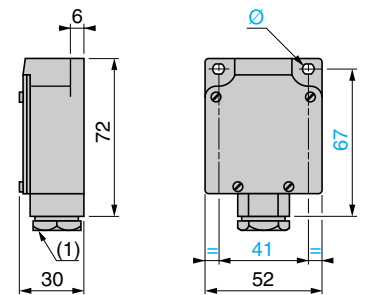

1. Incorporated cable entry.  
Ø: 2 elongated holes Ø 5.2 x 6.2.

Limit Switches

# Limit Switches

## Osiswitch® Classic, Metal

### XCKM and XCKL—Modular

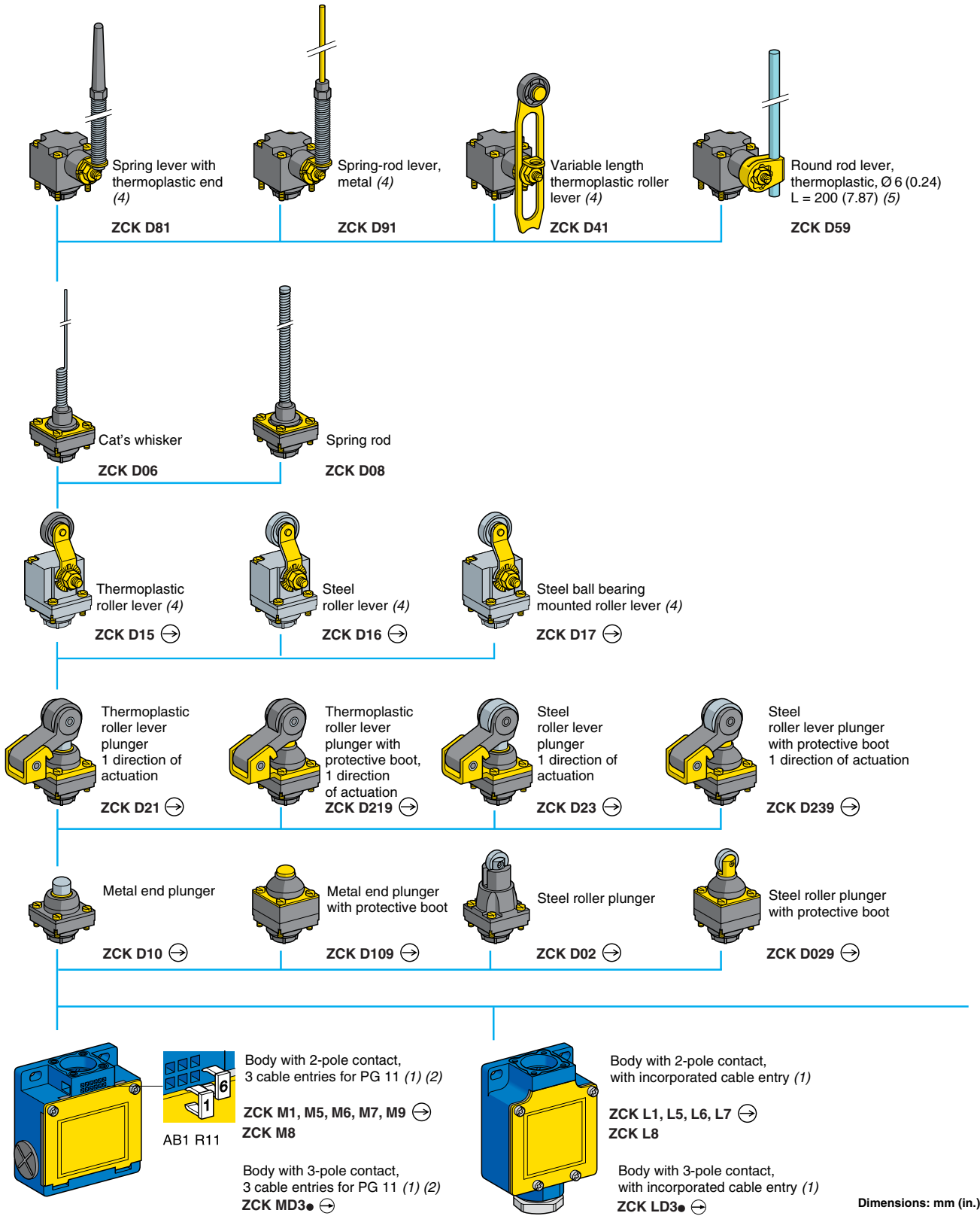

1. For further details, see page 88.  
 2. For 3 cable entries tapped ISO M20 x 1.5, add **H29** to the catalog number. Example: ZCKM1 becomes **ZCKM1H29**.

# Limit Switches

## Osiswitch® Classic, Metal

### XCKM and XCKL—Modular

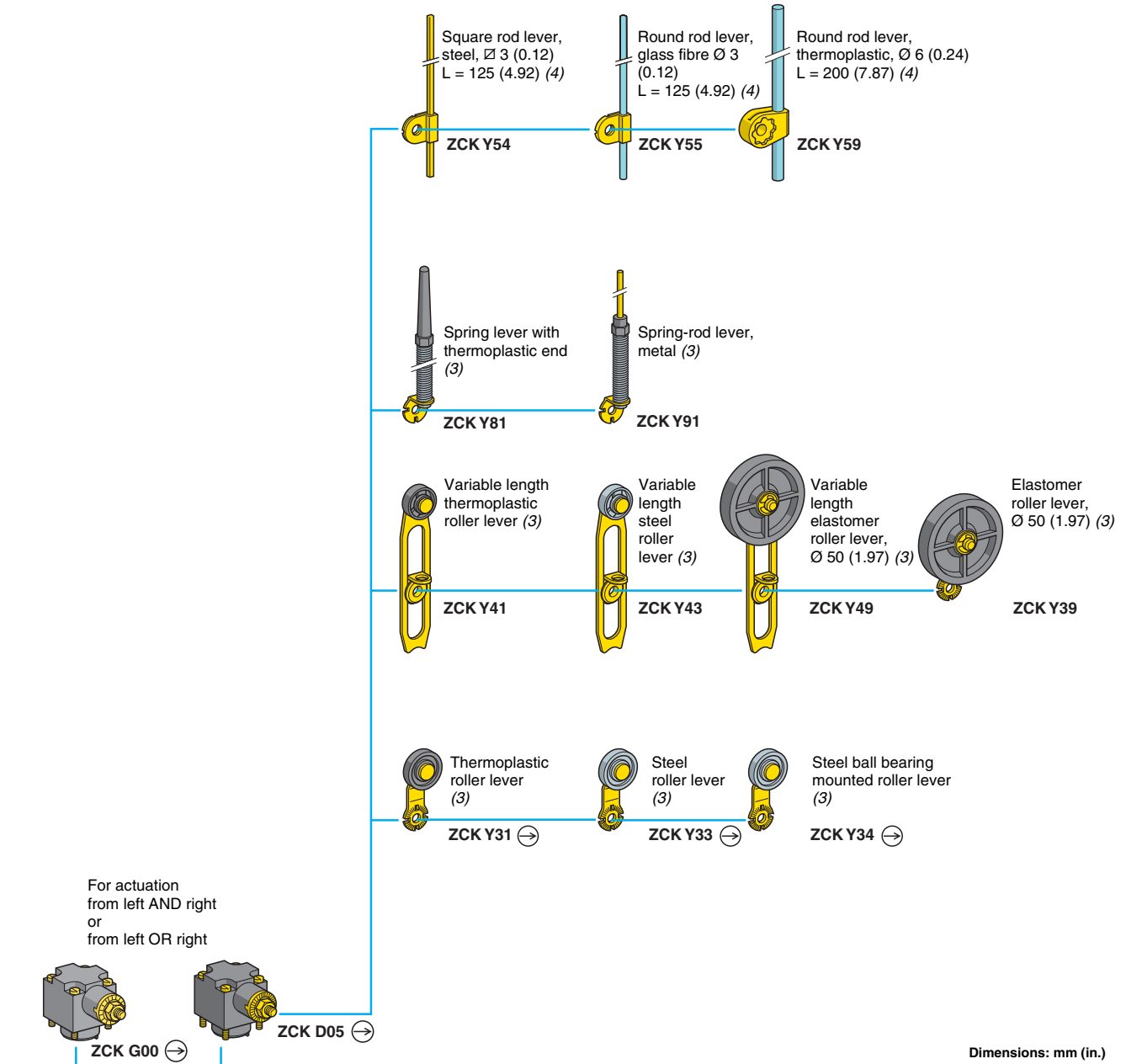

↻ head assuring positive opening operation, when properly mounted and using a conforming operator.

- 3. Adjustable throughout 360° in 5° steps, or in 90° steps by reversing the notched washer.
- 4. Adjustable throughout 360° in 5° steps, or in 45° steps by reversing the lever mounting.

# Limit Switches

## Osiswitch® Classic, Metal

### XCKM and XCKL—Modular

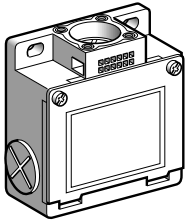

Limit Switches

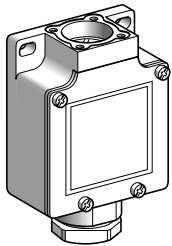

Bodies with 2-pole contact					
With contact block	Function diagram	Positive operation (1)	Cable entry	Catalog number	Weight kg (lb)
<b>For limit switches type XCKM</b>					
N/C + N/O snap action (XE2S P2151)			1/2" NPT (2)	ZCKM1	0.210 (0.463)
			ISO M20 x 1.5	ZCKM1H29	0.210 (0.463)
N/C + N/O break before make, slow break (XE2N P2151)			1/2" NPT (2)	ZCKM5	0.210 (0.463)
			ISO M20 x 1.5	ZCKM5H29	0.210 (0.463)
N/O + N/C make before make, slow break (XE2N P2161)			1/2" NPT (2)	ZCKM6	0.210 (0.463)
			ISO M20 x 1.5	ZCKM6H29	0.210 (0.463)
N/C + N/C simultaneous, slow break (XE2N P2141)			1/2" NPT (2)	ZCKM7	0.210 (0.463)
			ISO M20 x 1.5	ZCKM7H29	0.210 (0.463)
N/O + N/O simultaneous, slow break (XE2N P2131)		—	1/2" NPT (2)	ZCKM8	0.210 (0.463)
			ISO M20 x 1.5	ZCKM8H29	0.210 (0.463)
N/C + N/C snap action (XE2S P2141)			ISO M20 x 1.5	ZCKM9H29	0.210 (0.463)
<b>For limit switches type XCK L</b>					
N/C + N/O snap action (XE2S P2151)			1/2" NPT	ZCKL1	0.210 (0.463)
N/C + N/O break before make, slow break (XE2N P2151)			1/2" NPT	ZCKL5	0.210 (0.463)
N/O + N/C make before make, slow break (XE2N P2161)			1/2" NPT	ZCKL6	0.210 (0.463)
N/C + N/C simultaneous, slow break (XE2N P2141)			1/2" NPT	ZCKL7	0.210 (0.463)
N/O + N/O simultaneous, slow break (XE2N P2131)		—	1/2" NPT	ZCKL8	0.210 (0.463)

- : N/C contact with positive opening operation, when properly mounted and using a conforming operator.
- 3 PG 11 tapped entries, one with metal adapter for 1/2" NPT (USASB2-1) conduit (PG 8).

# Limit Switches

## Osiswitch® Classic, Metal

### XCKM and XCKL—Modular

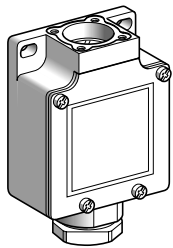
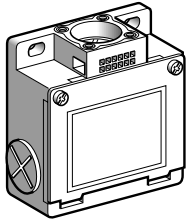

Bodies with 3-pole contact					
With contact block	Function diagram	Positive operation (1)	Cable entry	Catalog number	Weight kg (lb)
<b>For limit switches type XCKM</b>					
N/C + N/O + N/O snap action (XE3S P2151)			1/2" NPT (2)	ZCKMD31	0.210 (0.463)
			ISO M20 x 1.5	ZCKMD31H29	0.210 (0.463)
N/C + N/C + N/O snap action (XE3S P2141)			1/2" NPT (2)	ZCKMD39	0.210 (0.463)
			ISO M20 x 1.5	ZCKMD39H29	0.210 (0.463)
N/C + N/C + N/O break before make, slow break (XE3N P2141)			1/2" NPT (2)	ZCKMD37	0.210 (0.463)
			ISO M20 x 1.5	ZCKMD37H29	0.210 (0.463)
N/C + N/O + N/O break before make, slow break (XE3N P2151)			1/2" NPT (2)	ZCKMD35	0.210 (0.463)
			ISO M20 x 1.5	ZCKMD35H29	0.210 (0.463)
<b>For limit switches type XCK L</b>					
N/C + N/O + N/O snap action (XE3S P2151)			1/2" NPT	ZCKLD31	0.210 (0.463)
N/C + N/C + N/O snap action (XE3S P2141)			1/2" NPT	ZCKLD39	0.210 (0.463)
N/C + N/C + N/O break before make, slow break (XE3N P2141)			1/2" NPT	ZCKLD37	0.210 (0.463)
N/C + N/O + N/O break before make, slow break (XE3N P2151)			1/2" NPT	ZCKLD35	0.210 (0.463)

1. : N/C contact with positive opening operation, when properly mounted and using a conforming operator.
2. 3 PG 11 tapped entries, one with metal adapter for 1/2" NPT (USASB2-1) conduit (PG 8).

# Limit Switches

## Osiswitch® Classic, Metal

### XCKM and XCKL—Modular

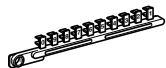
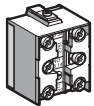
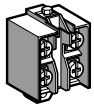
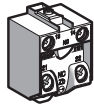

#### Contact blocks

Type of contact	Function diagram	For bodies	Positive operation (1)	Catalog number	Weight kg (lb)
<b>2-pole contact</b>					
N/C + N/O snap action		ZCKM1 ZCKL1	⊖	XE2S P2151	0.020 (0.044)
N/C + N/O break before make, slow break		ZCKM5 ZCKL5	⊖	XE2N P2151	0.020 (0.044)
N/O + N/C make before break, slow break		ZCKM6 ZCKL6	⊖	XE2N P2161	0.020 (0.044)
N/C + N/C simultaneous, slow break		ZCKM7 ZCKL7	⊖	XE2N P2141	0.020 (0.044)
N/O + N/O simultaneous, slow break		ZCKM8 ZCKL8	—	XE2N P2131	0.020 (0.044)
N/C + N/C snap action		ZCKM9	⊖	XE2S P2141	0.020 (0.044)
<b>3-pole contact</b>					
N/C + N/O + N/O snap action		ZCKMD31 ZCKLD31	⊖	XE3S P2151	0.035 (0.077)
N/C + N/C + N/O snap action		ZCKMD39 ZCKLD39	⊖	XE3S P2141	0.035 (0.077)
N/C + N/C + N/O break before make, slow break		ZCKMD37 ZCKLD37	⊖	XE3N P2141	0.035 (0.077)
N/C + N/O + N/O break before make, slow break		ZCKMD35 ZCKLD35	⊖	XE3N P2151	0.035 (0.077)

1. ⊖: N/C contact with positive opening operation or sub-assembly assuring positive opening operation when properly mounted and using a conforming operator.

#### Accessories for limit switches type XCKM

Description	Sold in lots of	Unit catalog number	Weight kg (lb)
Tap-off terminal for cabling continuity	1	XCK Z09	0.010 (0.022)
Clip-in markers (strips of 10 numbers: 0 to 9) Other markers, please consult your local sales office.	25	AB1 R11	0.002 (0.004)

**Other versions** Gold flashed contacts.  
Please consult your local sales office.

# Limit Switches

## Osiswitch® Classic, Metal

### XCKM and XCKL—Modular

Heads ZCKD10, D109 with body	<b>ZCKM1, L1</b> 	<b>ZCKM5, L5</b> 	<b>ZCKM6, L6</b> 	<b>ZCKM7, L7</b> 	<b>ZCKM8, L8</b> 
	<b>ZCKM9</b> 	<b>ZCKMD39, LD39</b> 	<b>ZCKMD37, LD37</b> 	<b>ZCKMD31, LD31</b> 	<b>ZCKMD35, LD35</b> 
Heads ZCKD02, D029 with body	<b>ZCKM1, L1</b> 	<b>ZCKM5, L5</b> 	<b>ZCKM6, L6</b> 	<b>ZCKM7, L7</b> 	<b>ZCKM8, L8</b> 
	<b>ZCKM9</b> 	<b>ZCKMD39, LD39</b> 	<b>ZCKMD37, LD37</b> 	<b>ZCKMD31, LD31</b> 	<b>ZCKMD35, LD35</b> 
Heads ZCKD21, D23, D219, D239 with body	<b>ZCKM1, L1</b> 	<b>ZCKM5, L5</b> 	<b>ZCKM6, L6</b> 	<b>ZCKM7, L7</b> 	<b>ZCKM8, L8</b> 
	<b>ZCKM9</b> 	<b>ZCKMD39, LD39</b> 	<b>ZCKMD37, LD37</b> 	<b>ZCKMD31, LD31</b> 	<b>ZCKMD35, LD35</b> 
Heads ZCKD15, D16, D17 with body	<b>ZCKM1, L1</b> 	<b>ZCKM5, L5</b> 	<b>ZCKM6, L6</b> 	<b>ZCKM7, L7</b> 	<b>ZCKM8, L8</b> 
	<b>ZCKM9</b> 	<b>ZCKMD39, LD39</b> 	<b>ZCKMD37, LD37</b> 	<b>ZCKMD31, LD31</b> 	<b>ZCKMD35, LD35</b> 
Heads ZCKD41, D59, D81, D91 with body	<b>ZCKM1, L1</b> 	<b>ZCKM5, L5</b> 	<b>ZCKM6, L6</b> 	<b>ZCKM7, L7</b> 	<b>ZCKM8, L8</b> 
	<b>ZCKM9</b> 	<b>ZCKMD39, LD39</b> 	<b>ZCKMD37, LD37</b> 	<b>ZCKMD31, LD31</b> 	<b>ZCKMD35, LD35</b> 
Heads ZCKD06, D08 with body	<b>ZCKM1, L1</b> 	<b>ZCKM5, L5</b> 	<b>ZCKM6, L6</b> 	<b>ZCKM7, L7</b> 	<b>ZCKM8, L8</b> 
	<b>ZCKM9</b> 	<b>ZCKMD39, LD39</b> 	<b>ZCKMD37, LD37</b> 	<b>ZCKMD31, LD31</b> 	<b>ZCKMD35, LD35</b> 

Contact operation

■ contact closed  
□ contact open

(A) = cam displacement  
(P) = positive opening point

# Limit Switches

## Osiswitch® Classic, Metal

### XCKM and XCKL—Modular

#### Bodies with contacts

ZCKM1, M5, M6, M7, M8,  
ZCKM1H29, M5H29, M6H29, M7H29, M8H29, M9H29

ZCKL1, L5, L6, L7, L8, LD3• (5)

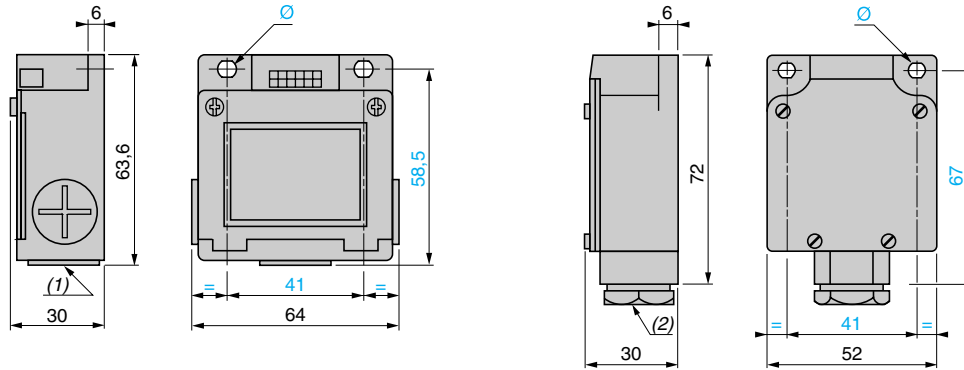

#### Adapter for 1/2" NPT conduit

DE9RA1012

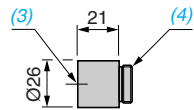

1. 3 tapped entries for ISO M20 x 1.5 or PG 11 conduit thread.
2. Incorporated cable entry.
- Ø: 2 elongated holes Ø 5.2 x 6.2.
3. Tapped entry for 1/2" NPT conduit.
4. Threaded sleeve, PG 11.
5. XCKL provided with 1/2" NPT adapter shown above, DE9RA1012.

### Complete Switches

For interpreting the complete switch catalog number only

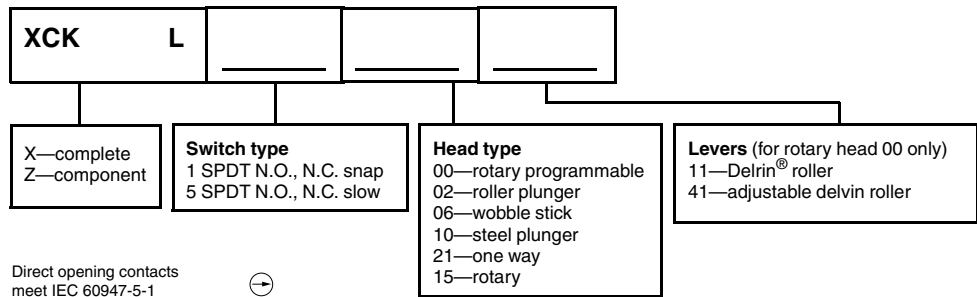

NOTE: Some combinations are not available. Use this information to interpret catalog numbers, not to create them.



# Limit Switches

## Osiswitch® Classic, Metal

### XCKM and XCKL—Modular

#### Plunger heads

##### ZCKD10

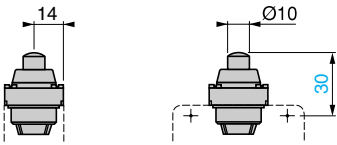

##### ZCKD109

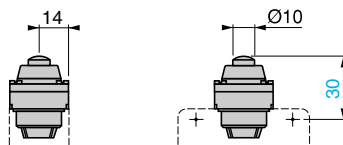

##### ZCKD02

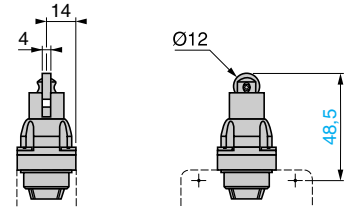

##### ZCKD029

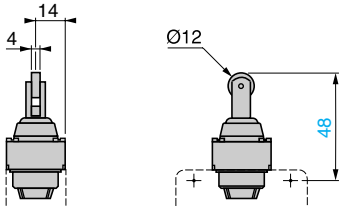

##### ZCKD21, D23

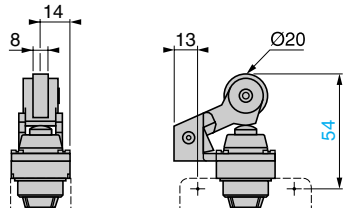

##### ZCKD219, D239

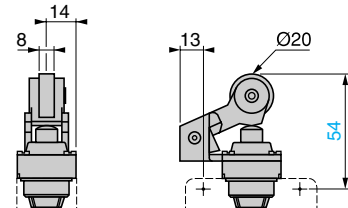

#### Rotary heads

##### ZCKD15, D16, D17

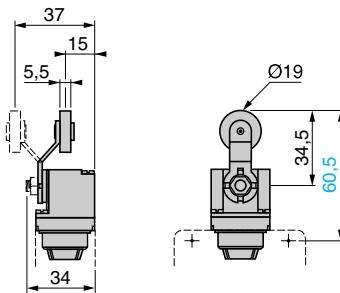

##### ZCKD41

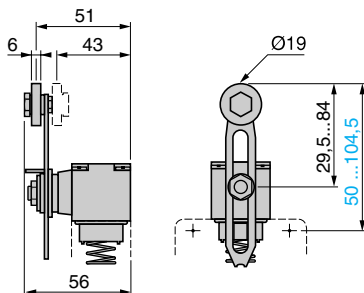

##### ZCKD59

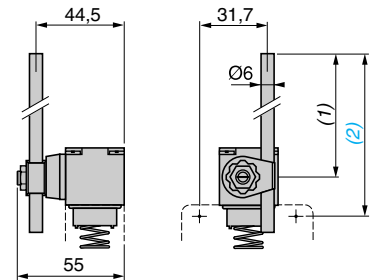

##### ZCKD81

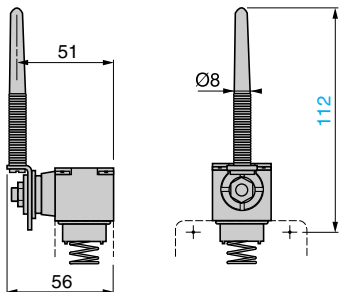

##### ZCKD91

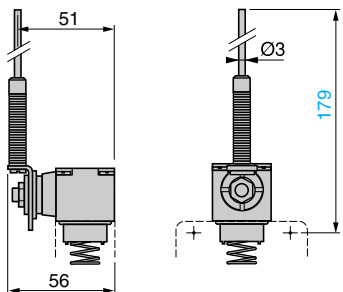

##### ZCKG00

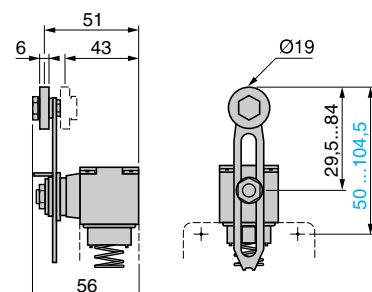

#### Multi-directional heads

##### ZCKD06

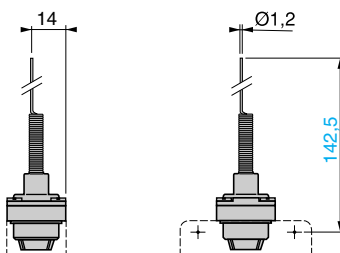

##### ZCKD08

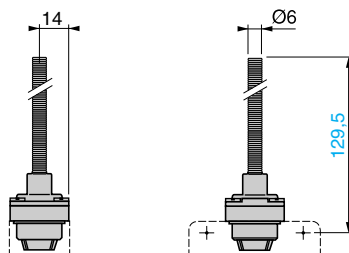

1. 190 max.
2. 215.5 max.

NOTE: operating lever spindle threaded M6.

Limit Switches

# Limit Switches

## Osiswitch® Classic, Metal

### XCKML, 2 x 2-Pole Contacts—Complete Switches

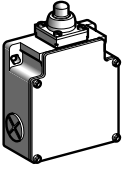
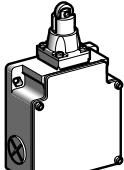
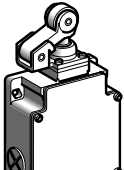
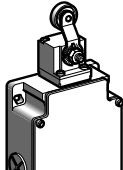
Type of head	Plunger (mounting by the body)			Rotary (mounting by the body)
				

Type of operator	Metal end plunger	Steel roller plunger	Thermoplastic roller lever plunger, horizontal actuation in 1 direction	Thermoplastic roller lever (1)
------------------	-------------------	----------------------	---	--------------------------------

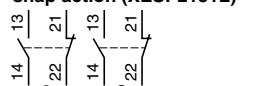
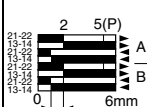
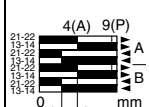
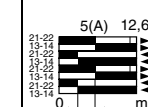
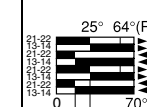
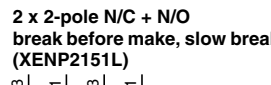
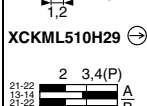
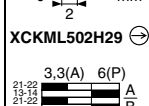
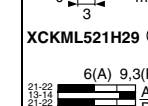

#### Catalog numbers (2)

#### Switches with 3 entries tapped ISO M20 x 1.5



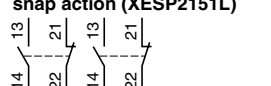
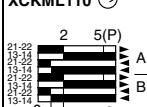
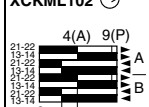
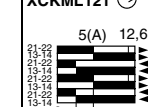
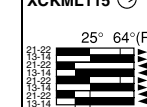
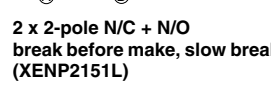
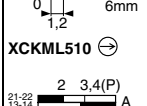
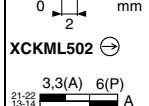
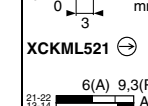

<b>2 x 2-pole N/C + N/O snap action (XESP2151L)</b> 	<b>XCKML110H29</b> ☞ 	<b>XCKML102H29</b> ☞ 	<b>XCKML121H29</b> ☞ 	<b>XCKML115H29</b> ☞ 
	<b>2 x 2-pole N/C + N/O break before make, slow break (XENP2151L)</b> 	<b>XCKML510H29</b> ☞ 	<b>XCKML502H29</b> ☞ 	<b>XCKML521H29</b> ☞ 

#### Switches with 3 entries tapped for PG 13 conduit thread, plus adapter for 1/2" NPT

<b>2 x 2-pole N/C + N/O snap action (XESP2151L)</b> 	<b>XCKML110</b> ☞ 	<b>XCKML102</b> ☞ 	<b>XCKML121</b> ☞ 	<b>XCKML115</b> ☞ 
	<b>2 x 2-pole N/C + N/O break before make, slow break (XENP2151L)</b> 	<b>XCKML510</b> ☞ 	<b>XCKML502</b> ☞ 	<b>XCKML521</b> ☞ 
<b>Weight, kg (lb)</b>	0.400 (0.882)	0.405 (0.893)	0.450 (0.992)	0.430 (0.948)

<b>Contact operation</b>	 contact closed  contact open	(A) = cam displacement (P) = positive opening point	☞ N/C contact with positive opening operation, when properly mounted and using a conforming operator
--------------------------	--	--	--

#### Characteristics

<b>Switch actuation</b>	On end	By 30° cam		
<b>Type of actuation</b>				
<b>Maximum actuation speed</b>	0.5 m/s (1.64 ft/s)		1.5 m/s (4.92 ft/s)	
<b>Minimum force</b>	For tripping	15 N (3.37 lb)	12 N (2.70 lb)	8 N (1.80 lb)
	For positive opening	60 N (13.49 lb)	50 N (11.24 lb)	50 N (11.24 lb)
<b>Cable entry</b>	3 entries tapped ISO M20 x 1.5, clamping capacity 7 to 13 mm (0.28 to 0.51 in.); or 3 entries tapped for PG 13 conduit thread conforming to NF C 68-300 (DIN PG 13.5), clamping capacity 9 to 12 mm (0.35 to 0.47 in.) (0.35 to 0.47 in.), plus adapter for 1/2" NPT			

- Adjustable throughout 360° in 5° steps, or in 90° steps by reversing the notched washer.
- Switches available with other 2-pole slow break contact blocks: N/O + N/C make before break, N/C + N/C simultaneous (with positive opening operation, when properly mounted and using a conforming operator), N/C + N/C simultaneous, please consult your local sales office.

**Note: replacement parts**  
 The heads of limit switches type XCKML are the same as those for types XCKM and XCKL (see heads ZCKD10, ZCKD02, ZCKD21 and ZCKD15 on page 86).

Limit Switches

# Limit Switches

## Osiswitch® Classic, Metal

### XCKML, 2 x 2-Pole Contacts—Complete Switches

XCKML110H29, XCKML510H29, XCKML110, XCKML510

XCKML102H29, XCKML502H29, XCKML102, XCKML502

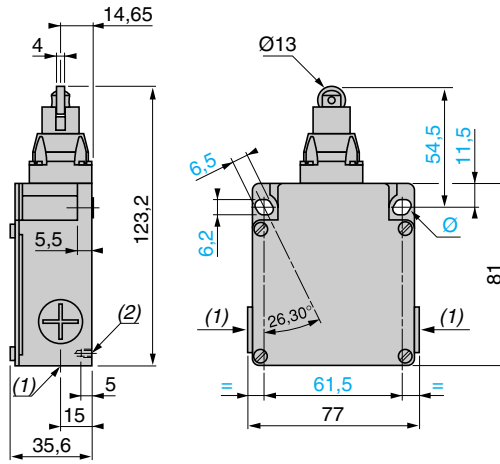
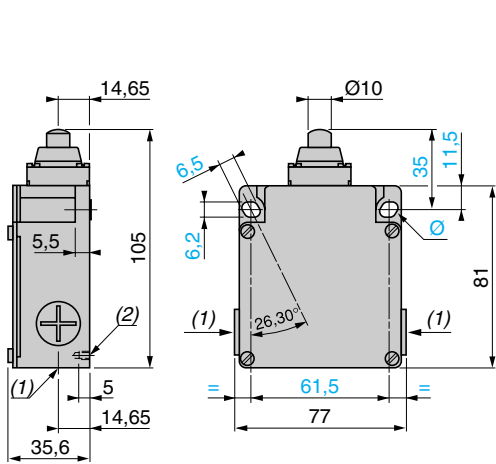

XCKML121H29, XCKML521H29, XCKML121, XCKML521

XCKML115H29, XCKML515H29, XCKML115, XCKML515

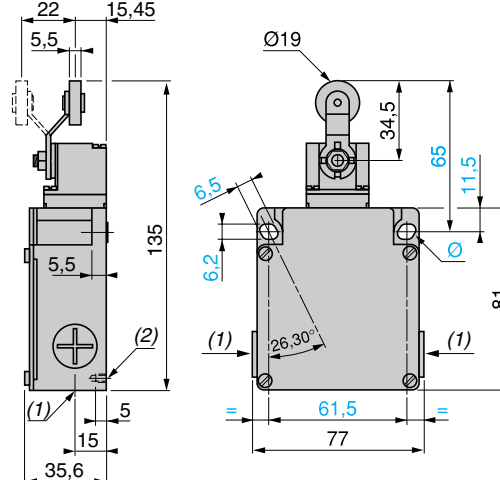
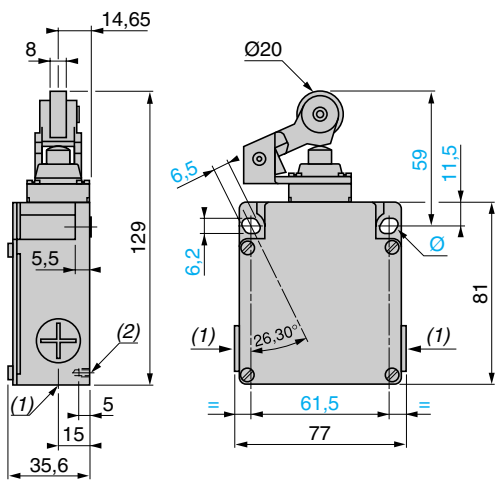

1. XCKML\*\*\*H29: 3 entries tapped M20 x 1.5. XCKML\*\*\*: 3 entries tapped for PG 13 conduit thread (adapter DE9RA1212 for 1/2" NPT available).
  2. 2 centering holes  $\varnothing 3.9 \pm 0.2$ , cover mounting holes axis.
- Ø: 2 elongated holes 6.2 x 6.5, inclined at 26°30' to the vertical axis, for M5 screws.

#### DE9RA1212 (PG 13 to 1/2" NPT adapter)

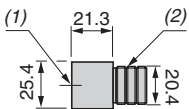

1. Tapped entry for 1/2" NPT conduit
2. PG 13 threaded sleeve

# Limit Switches

## Osiswitch® Classic, Metal, Conforming to CENELEC EN 50041

### XCKJ

■ XCKJ  
fixed, non-plug-in body with 1 cable entry

□ With head for linear movement (plunger)

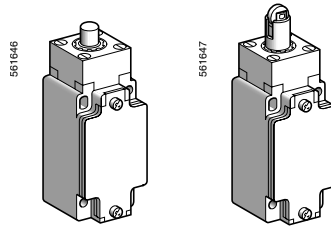

Page 98

□ With head for rotary movement (lever) or multi-directional

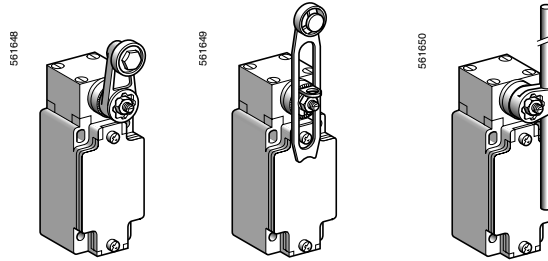

Page 98

■ XCKJ  
plug-in body with 1 cable entry

□ With head for linear movement (plunger)

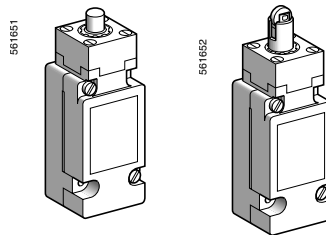

Page 100

□ With head for rotary movement (lever)

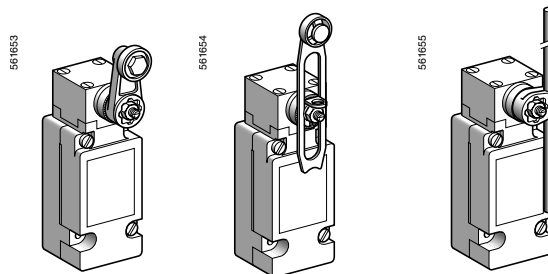

Page 100

#### Environment characteristics

<b>Conforming to standards</b>	Products	IEC 60947-5-1, EN 60947-5-1, UL 508, CSA C22-2 n° 14
	Machine assemblies	IEC 60204-1, EN 60204-1
<b>Product certifications</b>		UL, CSA, CCC
<b>Protective treatment</b>	Version	Standard "TC", special "TH"
<b>Ambient air temperature</b>	Operation	- 25...+70 °C (-13...+158 °F), special sub-assemblies available for extreme temperatures: -40 °C (-40 °F) or +120 °C (248 °F)
	Storage	- 40...+70 °C (-40...+158 °F)
<b>Vibration resistance</b>	Conforming to IEC 60068-2-6	25 gn (10...500 Hz)
<b>Shock resistance</b>	Conforming to IEC 60068-2-27	50 gn (11 ms)
<b>Electric shock protection</b>		Class I conforming to IEC 61140 and NF C 20-030
<b>Degree of protection</b>		NEMA Types 1, 2, 4, 12; IP 66 conforming to IEC 60529; IK 07 conforming to EN 50 102
<b>Repeat accuracy</b>		0.01 mm on the tripping points, with 1 million operating cycles for head with end plunger
<b>Cable entry or integral connector</b>	Depending on model	Tapped entry for PG 13 conduit thread, or tapped ISO M20 x 1.5 or 1/2" NPT, or M12 connector
<b>Materials</b>		Bodies and heads in Zamak® zinc alloy

# Limit Switches

## Osiswitch® Classic, Metal, Conforming to CENELEC EN 50041

### XCKJ

Contact block characteristics		
Rated operational characteristics	XE2•P	~ AC-15; A300 (Ue = 240 V, Ie = 3 A); Ithe = 10 A = DC-13; Q300 (Ue = 250 V, Ie = 0.27 A), conforming to IEC 60947-5-1 appendix A, EN 60947-5-1
	XE3•P	~ AC-15; B300 (Ue = 240 V, Ie = 1.5 A); Ithe = 6 A = DC-13; R300 (Ue = 250 V, Ie = 0.1 A), conforming to IEC 60947-5-1 appendix A, EN 60947-5-1
Rated insulation voltage	XE2•P	Ui = 500 V degree of pollution 3 conforming to IEC 60947-1 Ui = 300 V conforming to UL 508, CSA C22-2 n° 14
	XE3•P	Ui = 400 V degree of pollution 3 conforming to IEC 60947-1 Ui = 300 V conforming to UL 508, CSA C22-2 n° 14
Rated impulse withstand voltage	XE2•P	U imp = 6 kV conforming to IEC 60947-1, IEC 60664
	XE3•P	U imp = 4 kV conforming to IEC 60947-1, IEC 60664
Positive operation (depending on model)		N/C contacts with positive opening operation conforming to IEC 60947-5-1 Appendix K, EN 60947-5-1
Resistance across terminals		≤ 25 mΩ conforming to IEC 60255-7 category 3
Short-circuit protection	XE2•P	10 A cartridge fuse type gG (gl)
	XE3•P	6 A cartridge fuse type gG (gl)
Cabling (screw clamp terminals)	XE2SP21•1	Clamping capacity, min: 1 x 0.34 mm <sup>2</sup> , max: 2 x 1.5 mm <sup>2</sup>
	XE2NP21•1	Clamping capacity, min: 1 x 0.5 mm <sup>2</sup> , max: 2 x 2.5 mm <sup>2</sup>
	XCKJ plug-in and XESP20•1	Clamping capacity, min: 1 x 0.75 mm <sup>2</sup> , max: 2 x 1.5 mm <sup>2</sup>
	XE3NP and XE3SP	Clamping capacity, min: 1 x 0.34 mm <sup>2</sup> , max: 1 x 1 mm <sup>2</sup> or 2 x 0.75 mm <sup>2</sup>
Minimum actuation speed	XE2SP21•1 and XE3SP	0.01 m/minute (0.03 ft/minute)
	XE2NP21•1 and XE3NP	6 m/minute (19.68 ft/minute)

- Electrical durability**
- Conforming to IEC 60947-5-1 Appendix C
  - Utilization categories AC-15 and DC-13
  - Maximum operating rate: 3600 operating cycles/hour
  - Load factor: 0.5

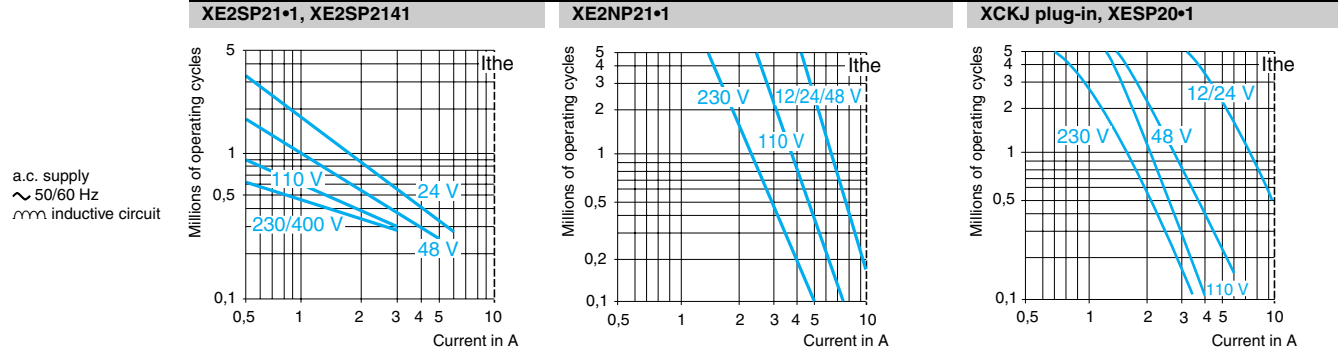

d.c. supply =

Power switched in W for 5 million operating cycles.				
Voltage	V	24	48	120
∞	W	10	7	4

Power switched in W for 5 million operating cycles.				
Voltage	V	24	48	120
∞	W	13	9	7

Power switched in W for 5 million operating cycles.				
Voltage	V	24	48	120
∞	W	10	7	4



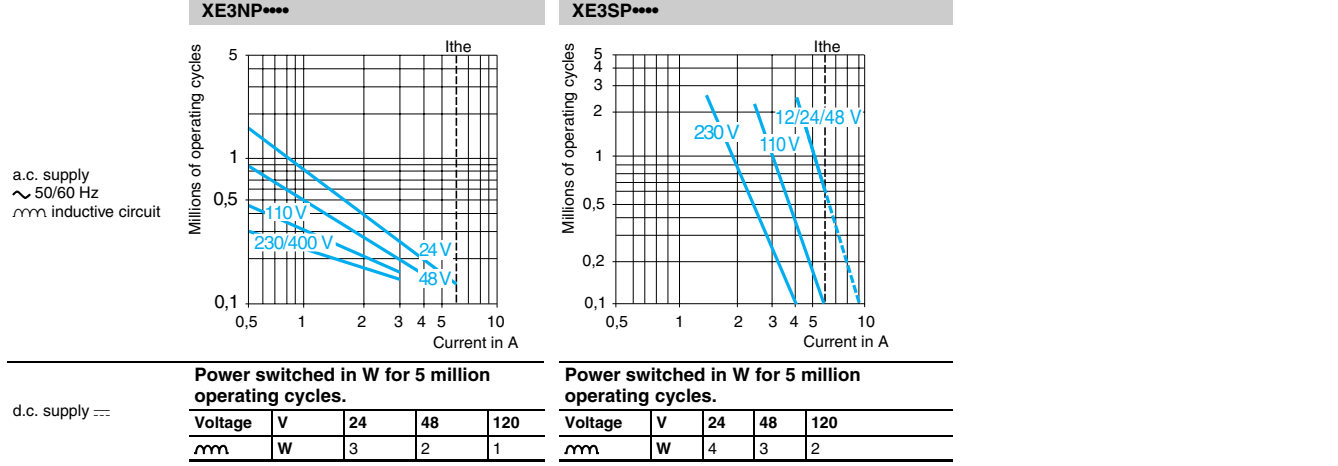







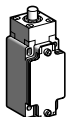
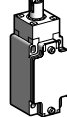
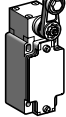
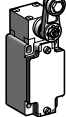
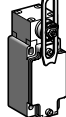





For XE2SP•151 on ~ or =, N/C and N/O contacts simultaneously loaded to the values shown with reverse polarity.



Limit Switches

# Limit Switches

## Osiswitch® Classic, Metal, Conforming to CENELEC EN 50041 XCKJ—Complete Switches, Fixed Non-plug-in Body, 1/2" NPT Cable Entry

Type of head	Plunger (mounting by the body)		Rotary (mounting by the body) (switches supplied for actuation from left AND right)				
	Form B (1)	Form C (1)	Form A (1)			Form D (1)	
							
Type of operator	Metal end plunger	Steel roller plunger	Thermoplastic roller lever (3)	Steel roller lever (3)	Variable length thermoplastic roller lever (3)	Round thermoplastic rod lever, Ø 6 mm (0.24 in.) (3) (4)	
<b>Catalog numbers (2)</b>							
	2-pole N/C + N/O snap action (XE2S P2151)	XCKJ161	XCKJ167	XCKJ10511	XCKJ10513	XCKJ10541	XCKJ10559
	2-pole N/C + N/O break before make, slow break (XE2N P2151)	XCKJ561	XCKJ567	XCKJ50511	XCKJ50513	XCKJ50541	XCKJ50559
	2-pole N/C + N/C snap action (XE2S P2141)	ZCKJ9 + ZCKE61	ZCKJ9 + ZCKE67	ZCKJ9 + ZCKE05 + ZCKY11	ZCKJ9 + ZCKE05 + ZCKY13	ZCKJ9 + ZCKE05 + ZCKY41	ZCKJ9 + ZCKE05 + ZCKY59
	2-pole N/C + N/C simultaneous, slow break (XE2N P2141)	ZCKJ7 + ZCKE61	ZCKJ7 + ZCKE67	ZCKJ7 + ZCKE05 + ZCKY11	ZCKJ7 + ZCKE05 + ZCKY13	ZCKJ7 + ZCKE05 + ZCKY41	ZCKJ7 + ZCKE05 + ZCKY59
	3-pole N/C + N/C + N/O snap action (XE3S P2141)	ZCKJD39 + ZCKE61	ZCKJD39 + ZCKE67	ZCKJD39 + ZCKE05 + ZCKY11	ZCKJD39 + ZCKE05 + ZCKY13	ZCKJD39 + ZCKE05 + ZCKY41	ZCKJD39 + ZCKE05 + ZCKY59
	3-pole N/C + N/C + N/O break before make, slow break (XE3N P2141)	ZCKJD37 + ZCKE61	ZCKJD37 + ZCKE67	ZCKJD37 + ZCKE05 + ZCKY11	ZCKJD37 + ZCKE05 + ZCKY13	ZCKJD37 + ZCKE05 + ZCKY41	ZCKJD37 + ZCKE05 + ZCKY59
Weight, kg (lb)	0.430 (0.948)	0.455 (1.003)	0.480 (1.058)	0.490 (1.080)	0.485 (1.069)	0.485 (1.069)	
Contact operation	 contact closed  contact open		(A) = cam displacement (P) = positive opening point		 N/C contact with positive opening operation, when properly mounted and using a conforming operator		
<b>Characteristics</b>							
Switch actuation	On end	By 30° cam				By any moving part	
Type of actuation							
Maximum actuation speed	0.5 m/s (1.64 ft/s)	1 m/s (3.28 ft/s)	1.5 m/s (4.92 ft/s)		—		
Minimum force or torque	For tripping: 20 N (4.50 lb) For positive opening: 50 N (11.24 lb)	16 N (3.60 lb) 40 N (8.99 lb)	0.25 N•m (2.21 lb-in) 0.50 N•m (4.43 lb-in)		—		
Cable entry	1 entry tapped 1/2" NPT for ISO cable entry, clamping capacity 9 to 12 mm (0.35 to 0.47 in.)						

- Form conforming to EN 50041, see page 21.
- Switches with gold contacts or eyelet type connections: please consult your local sales office.
- Adjustable throughout 360° in 5° steps, or in 45° steps by reversing the lever or its mounting.
- Value taken with actuation by moving part at 100 mm (3.94 in.) from the mounting.

# Limit Switches

## Osiswitch® Classic, Metal, Conforming to CENELEC EN 50041

### XCKJ—Complete Switches, Fixed Non-plug-in Body, 1/2" NPT Cable Entry

**XCKJ•61**  
ZCKJ•+ ZCKE61

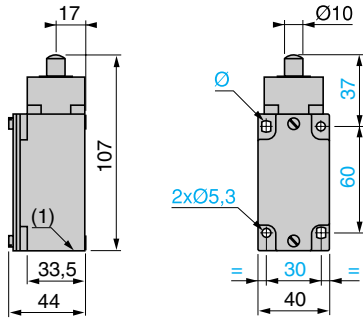

**XCKJ•67**  
ZCKJ•+ ZCKE67

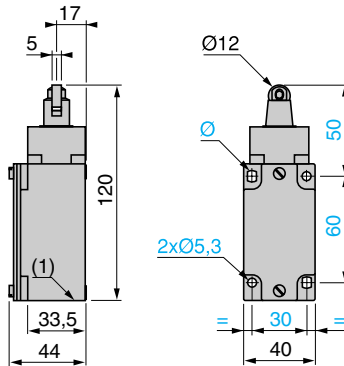

**XCKJ•051•**  
ZCKJ•+ ZCKE05 + ZCKY11 or Y13

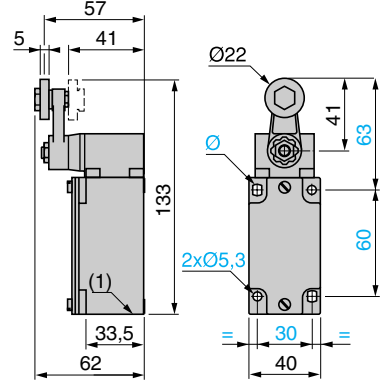

**XCKJ•0541**  
ZCKJ•+ ZCKE05 + ZCKY41

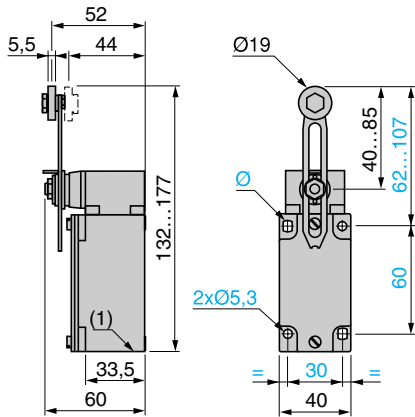

**XCKJ•0559**  
ZCKJ•+ ZCKE05 + ZCKY59

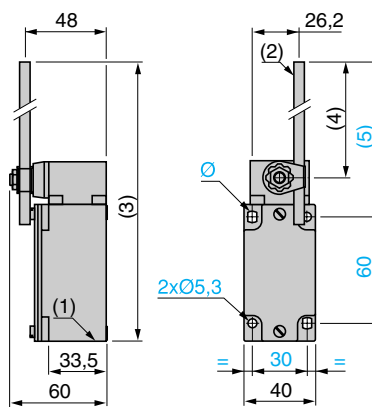

1. 1 tapped entry for 1/2" NPT.
  2. Rod Ø 6 mm (0.24 in.), length 200 mm (7.87 in.).
  3. 282 max.
  4. 190 max.
  5. 212 max.
- Ø: 2 elongated holes Ø 5.3 x 7.3.

Limit Switches

### For Interpretation of the Complete Switch Catalog Number Only



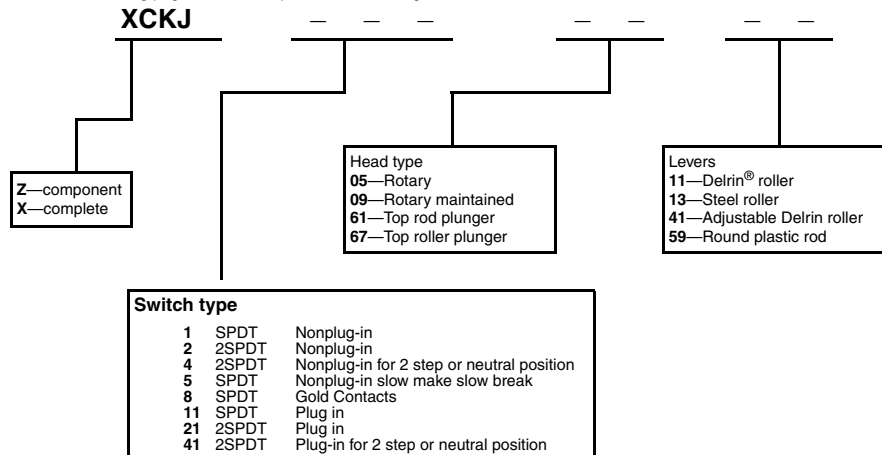







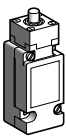
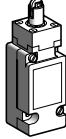

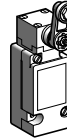
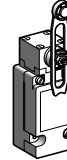
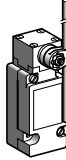

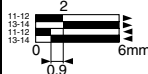
Note: See following pages for the complete switch offering

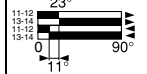
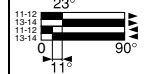
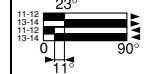
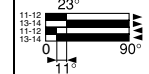

# Limit Switches

## Osiswitch® Classic, Metal, Conforming to CENELEC EN 50041

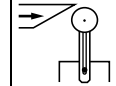
### XCKJ—Complete Switches, Plug-in Body, 1/2" NPT Cable Entry

Type of head	Plunger (mounting by the body)		Rotary (mounting by the body) (switches supplied for actuation from left AND right)			
	Form B (1)	Form C (1)	Form A (1)		Form D (1)	
						
Type of operator	Metal end plunger	Steel roller plunger	Thermoplastic roller lever (3)	Steel roller lever (3)	Variable length thermoplastic roller lever (3)	Round thermoplastic rod lever, Ø 6 mm (0.24 in.) (3) (4)
<b>Catalog numbers (2)</b>						
 Single-pole C/O snap action	<b>XCKJ1161</b>	<b>XCKJ1167</b>	<b>XCKJ110511</b>	<b>XCKJ110513</b>	<b>XCKJ110541</b>	<b>XCKJ110559</b>
						
Weight, kg (lb)	0.430 (0.948)	0.455 (1.003)	0.480 (1.058)	0.490 (1.080)	0.485 (1.069)	0.485 (1.069)
Contact operation	 contact closed  contact open		(A) = cam displacement			
<b>Characteristics</b>						
Switch actuation	On end	By 30° cam			By any moving part	
Type of actuation						
Maximum actuation speed	0.5 m/s (1.64 ft/s)	1 m/s (3.28 ft/s)	1.5 m/s (4.92 ft/s)			
Minimum force or torque for tripping	20 N (4.50 lb)	16 N (3.60 lb)	0.25 N•m (2.21 lb-in)			
Cable entry	1 entry tapped for 1/2" NPT cable entry. Clamping capacity 7 to 13 mm (0.28 to 0.51 in.)					

- Form conforming to EN 50041, see page 21.
- Switches with gold contacts: please consult your local sales office.
- Adjustable throughout 360° in 5° steps, or in 45° steps by reversing the lever mounting or clamp.
- Value taken with actuator operating at 100 mm (3.94 in.) from the mounting.



# Limit Switches

Osiswitch® Classic, Metal, Conforming to CENELEC EN 50041

XCKJ—Complete Switches, Plug-in Body, 1/2" NPT Cable Entry

XCKJ1611

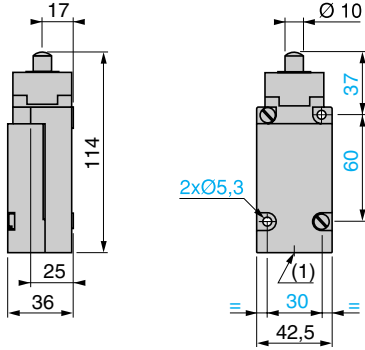

XCKJ1167

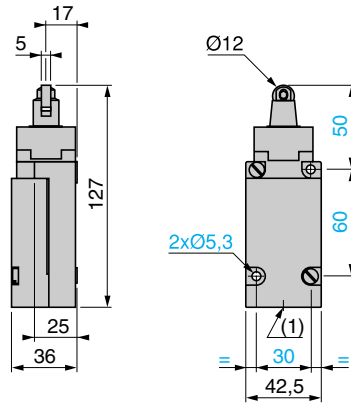

XCKJ110511, XCKJ110513

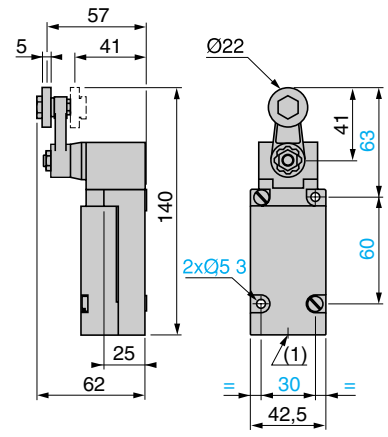

XCKJ110541

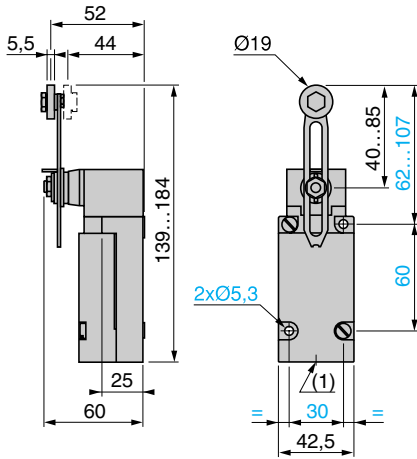

XCKJ110559

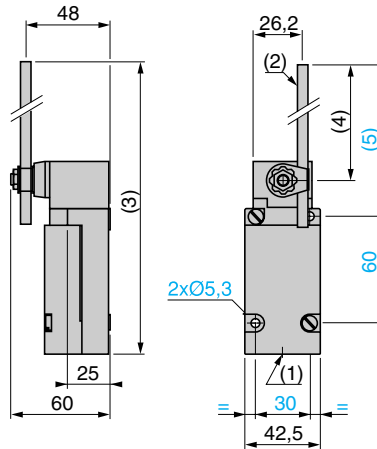



1. Tapped entry for 1/2" NPT conduit.
2. Rod Ø 6 mm (0.24 in.), length 200 mm (7.87 in.).
3. 289 max.
4. 190 max.
5. 212 max.

Limit Switches

# Limit Switches

## Osiswitch® Classic, Metal, Conforming to CENELEC EN 50041

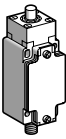
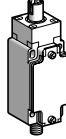
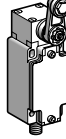
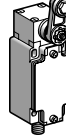

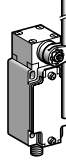
### XCKJ—Complete Switches, Fixed Non-plug-in Body, Integral M12 Connector

Type of head	Plunger (mounting by the body)		Rotary (mounting by the body) (switches supplied for actuation from left AND right)			
	Form B (1)	Form C (1)	Form A (1)			Form D (1)
						



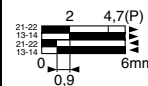
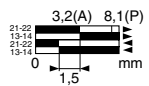
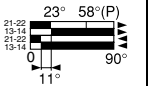
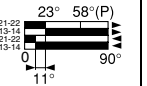
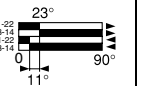

Type of operator	Metal end plunger	Steel roller plunger	Thermoplastic roller lever (2)	Steel roller lever (2)	Variable length thermoplastic roller lever (2)	Round thermoplastic rod lever, Ø 6 mm (0.24 in.) (2) (3)
------------------	-------------------	----------------------	--------------------------------	------------------------	--	--

#### Catalog numbers (4)

2-pole N/C + N/O snap action (XE2SP2151)	XCKJ161D	XCKJ167D	XCKJ10511D	XCKJ10513D	XCKJ10541D	XCKJ10559D
						
Weight, kg (lb)	0.430 (0.948)	0.455 (1.003)	0.480 (1.058)	0.490 (1.080)	0.485 (1.069)	0.485 (1.069)

**Contact operation**  
 contact closed  
 contact open  
 (A) = cam displacement  
 (P) = positive opening point

#### Characteristics

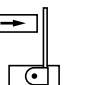
Switch actuation	On end	By 30° cam	By any moving part		
Type of actuation					
Maximum actuation speed	0.5 m/s (1.64 ft/s)	1 m/s (3.28 ft/s)	1.5 m/s (4.92 ft/s)		
Minimum force or torque	For tripping	20 N (4.50 lb)	16 N (3.60 lb)	0.25 N•m (2.21 lb-in)	
	For positive opening	50 N (11.24 lb)	40 N (8.99 lb)	0.50 N•m (4.43 lb-in)	
Connection	M12 5-pin connector, Ui = 60 V, Ie = 4 A (see suitable pre-wired female connectors below).				

- Form conforming to EN 50041, see page 21.
- Adjustable throughout 360° in 5° steps, or in 45° steps by reversing the lever or its mounting.
- Value taken with actuation by moving part at 100 mm (3.94 in.) from the mounting.
- Switches with gold contacts: please consult your local sales office.

#### Catalog numbers of suitable pre-wired female connectors

Type of connector	Length (L)	M12 straight, 5-pin, 4 A/24 V max.	M12 elbowed, 5-pin, 4 A/24 V max.
With cable, Ø 5.8 mm (0.23 in.) (4 x 0.34 mm <sup>2</sup> + 1 x 0.5 mm <sup>2</sup> )	2 m (6.56 ft)	XZCP1164L2	XZCP1264L2
	5 m (16.40 ft)	XZCP1164L5	XZCP1264L5
	10 m (32.8 ft)	XZCP1164L10	XZCP1264L10
Weight, kg (lb)	2 m (6.56 ft)	0.115 (0.254)	
	5 m (16.40 ft)	0.270 (0.595)	
	10 m (32.8 ft)	0.520 (1.146)	

Limit Switches

# Limit Switches

Osiswitch® Classic, Metal, Conforming to CENELEC EN 50041

XCKJ—Complete Switches, Fixed Non-plug-in Body, Integral M12 Connector

## Dimensions

XCKJ161D

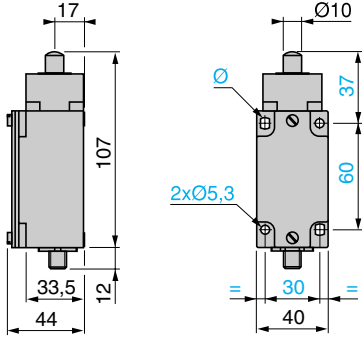

XCKJ167D

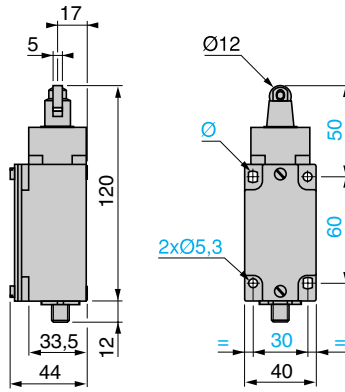

XCKJ1051•D

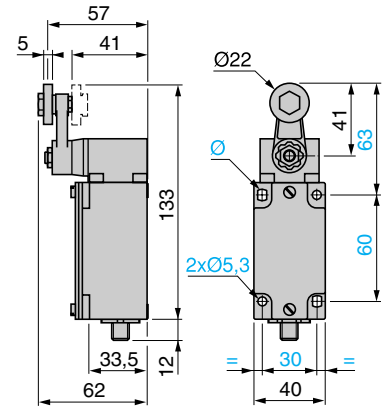

XCKJ10541D

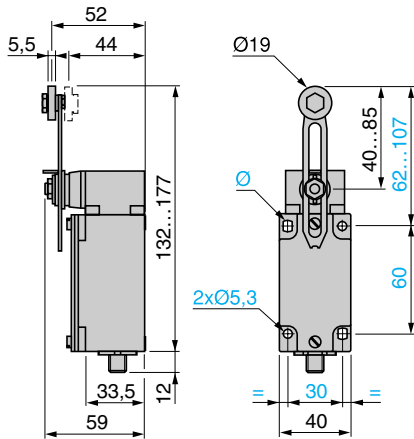

XCKJ10559D

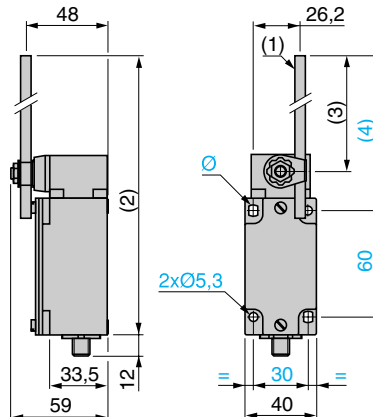

XZCP1164L•

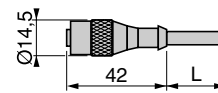

XZCP1264L•

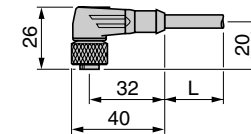

- 1. Rod Ø 6 mm (0.24 in.), length 200 mm (7.87 in.)
- 2. 282 max.
- 3. 190 max.
- 4. 212 max.
- Ø: 2 elongated holes Ø 5.3 x 7.3
- L: Cable length 2, 5, or 10 m (6.6, 16.4, or 32.8 ft)

## Connections

Limit switch XCKJ••••D

Pre-wired female connector XZCP1•64L•

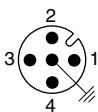

- 1-2 = N/C
- 3-4 = N/O
- 5 =  $\perp$
- 4 A / 24 V max.

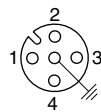











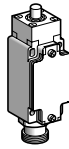
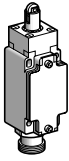
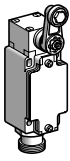
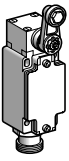
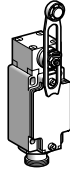
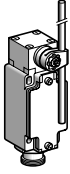

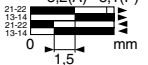
- 1 = brown
- 2 = white
- 3 = blue
- 4 = black
- 5 =  $\perp$  yellow/green

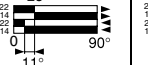
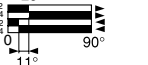
Limit Switches

# Limit Switches

## Osiswitch® Classic, Metal, Conforming to CENELEC EN 50041

### XCKJ—Complete Switches, Fixed Non-plug-in Body, Integral 7/8" 16UN connector

Type of head	Plunger (mounting by the body)		Rotary (mounting by the body) (switches supplied for actuation from left AND right)			
	Form B (1)	Form C (1)	Form A (1)		Form D (1)	
						
Type of operator	Metal end plunger	Steel roller plunger	Thermoplastic roller lever (2)	Steel roller lever (2)	Variable length thermoplastic roller lever (2)	Round thermoplastic rod lever, Ø 6 mm (0.24 in.) (2) (3)
<b>Catalog numbers (4)</b>						
 2-pole N/C + N/O snap action (XE2SP2151)	<b>XCKJ161A</b> 	<b>XCKJ167A</b> 	<b>XCKJ10511A</b> 	<b>XCKJ10513A</b> 	<b>XCKJ10541A</b> 	<b>XCKJ10559A</b> 
	Weight, kg (lb)	0.430 (0.948)	0.455 (1.003)	0.480 (1.058)	0.490 (1.080)	0.485 (1.069)
Contact operation	 contact closed  contact open		(A) = cam displacement (P) = positive opening point	 N/C contact with positive opening operation, when properly mounted and using a conforming operator		
<b>Characteristics</b>						
Switch actuation	On end	By 30° cam				By any moving part
Type of actuation						
Maximum actuation speed	0.5 m/s (1.64 ft/s)	1 m/s (3.28 ft/s)	1.5 m/s (4.92 ft/s)			
Minimum force or torque	For tripping	20 N (4.50 lb)	16 N (3.60 lb)	0.25 N•m (2.21 lb-in)		
	For positive opening	50 N (11.24 lb)	40 N (8.99 lb)	0.50 N•m (4.43 lb-in)		
Connection	7/8" 16UN 5-pin connector, U <sub>i</sub> = 250 V; I <sub>e</sub> = 6 A (see suitable pre-wired female connectors below).					

1. Form conforming to EN 50041, see page 21.
2. Adjustable throughout 360° in 5° steps, or in 45° steps by reversing the lever mounting or clamp.
3. Value taken with actuator operating at 100 mm (3.94 in.) from the mounting.
4. Switches with gold contacts: please consult your local sales office.

#### Catalog numbers of suitable pre-wired female connectors

Type of connector	Length (L)	7/8" 16UN straight, 5-pin, 6 A/250 V max.
With cable, Ø 6.7 mm (5 x 0.5 mm <sup>2</sup> )	2 m (6.56 ft)	<b>XZCP1771L2</b>
	5 m (16.40 ft)	<b>XZCP1771L5</b>
	10 m (32.8 ft)	<b>XZCP1771L10</b>
Weight, kg (lb)	2 m (6.56 ft)	0.190 (0.419)
	5 m (16.40 ft)	0.475 (1.047)
	10 m (32.8 ft)	0.950 (2.094)

# Limit Switches

Osiswitch® Classic, Metal, Conforming to CENELEC EN 50041

XCKJ—Complete Switches, Fixed Non-plug-in Body, Integral 7/8" 16UN connector

## Dimensions

XCKJ161A

XCKJ167A

XCKJ1051•A

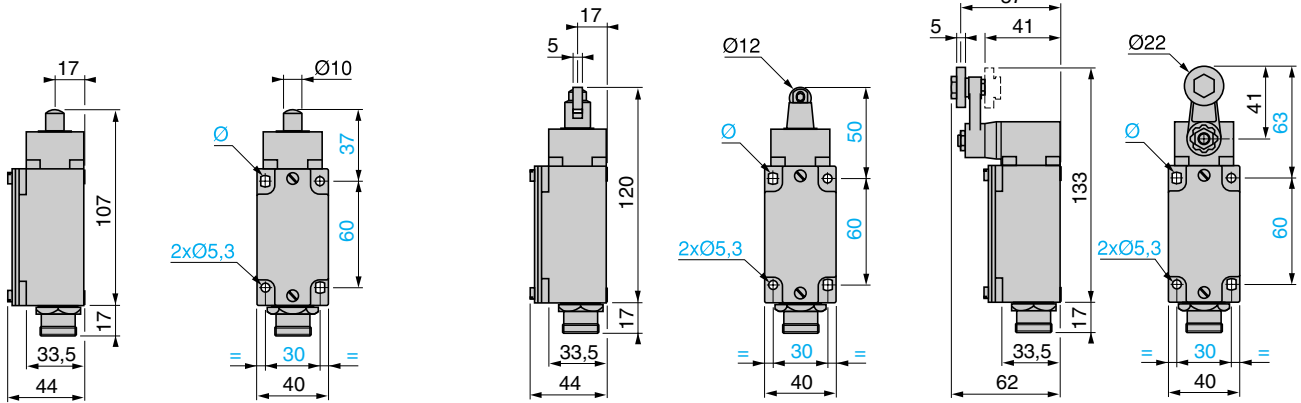

XCKJ10541A

XCKJ10559A

XZCP1771L•

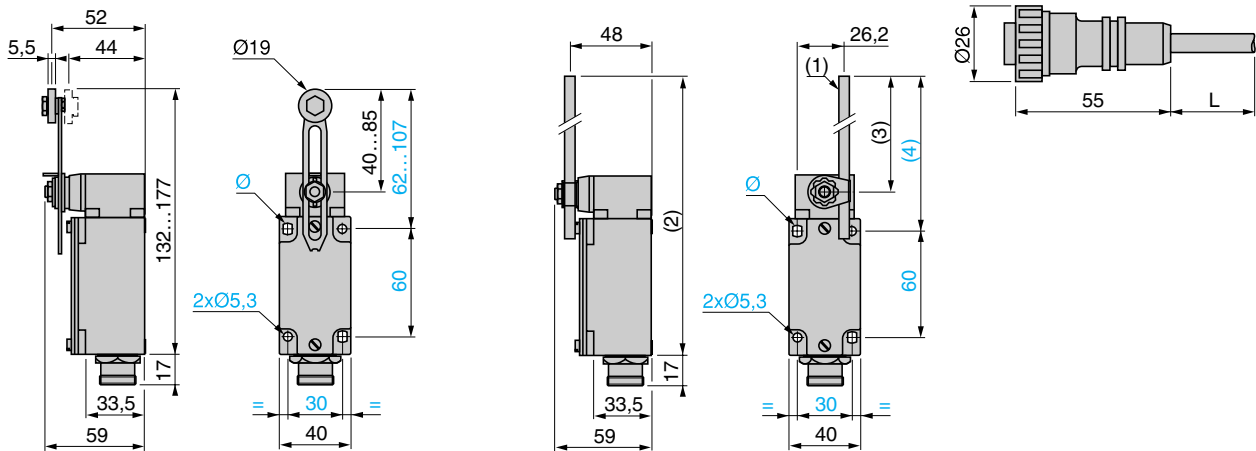

- 1. Rod  $\varnothing$  6 mm (0.24 in.), length 200 mm (7.87 in.)
- 2. 282 max.
- 3. 190 max.
- 4. 212 max.
- $\varnothing$ : 2 elongated holes  $\varnothing$  5.3 x 7.3
- L: cable length: 2, 5, or 10 m (6.6, 16.4, or 32.8 ft)

## Connections

Limit switch XCKJ\*\*\*A

Pre-wired female connector XZCP1771L•

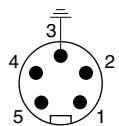

- 1 = 21
- 2 = 22
- 3 = 1
- 4 = 14
- 5 = 13

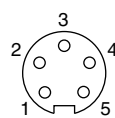

- 1 = black
- 2 = blue
- 3 = yellow/green  $\perp$
- 4 = brown
- 5 = white

# Limit Switches

## Osiswitch® Classic, Metal, Conforming to CENELEC EN 50041

### XCKJ—Modular, Fixed Non-plug-in or Plug-in Bodies

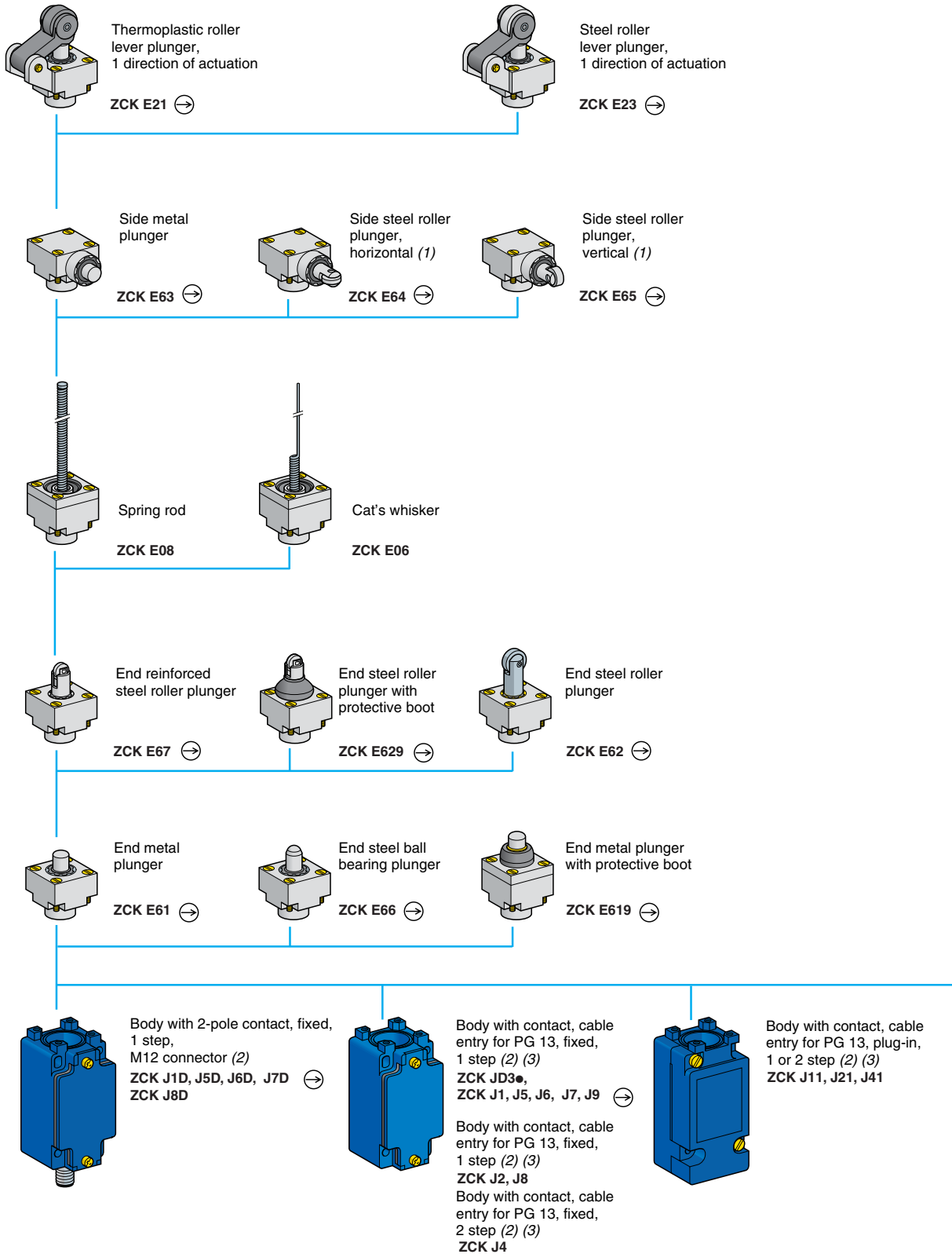

1. Cannot be used with bodies ZCKJ4 and ZCKJ41.
2. For further details, see page 108.
3. For a cable entry tapped ISO M20 x 1.5, add **H29** to the catalog number. Example: ZCKJ1 becomes **ZCKJ1H29**.  
For a cable entry tapped 1/2" NPT, do not add an H code to the catalog number. Example: **ZCKJ1**.

# Limit Switches

## Osiswitch® Classic, Metal, Conforming to CENELEC EN 50041

### XCKJ—Modular, Fixed Non-plug-in or Plug-in Bodies

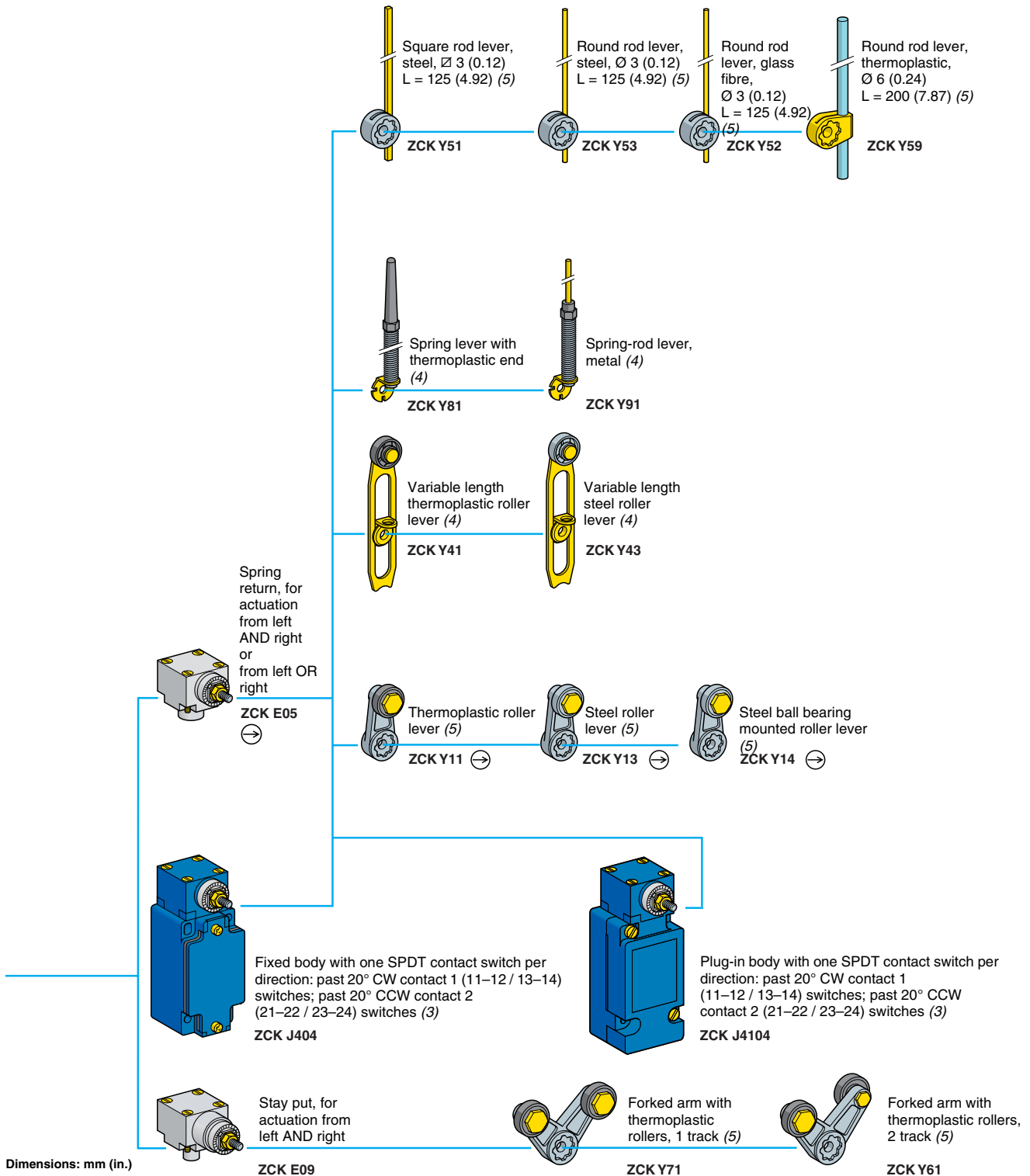

⊙: head assuring positive opening operation, when properly mounted and using a conforming operator.

- 4. Adjustable throughout 360° in 5° steps, or in 90° steps by reversing the notched washer.
- 5. Adjustable throughout 360° in 5° steps, or in 45° steps by reversing the lever mounting.

# Limit Switches

## Osiswitch® Classic, Metal, Conforming to CENELEC EN 50041

### XCKJ—Modular, Fixed Non-plug-in or Plug-in Bodies with 1/2" NPT Cable Entry

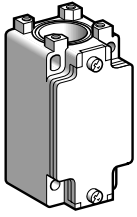

Fixed bodies with 2-pole contact						
Type	With contact block	Function diagram	Positive operation (1)	Cable entry	Catalog number	Weight kg (lb)
1 step	N/C + N/O snap action (XE2S P2151)		⊕	1/2" NPT	ZCKJ1	0.310 (0.683)
				ISO M20 x 1.5	ZCKJ1H29	0.310 (0.683)
	2 C/O simultaneous, snap action (XES P2021)		-	1/2" NPT	ZCKJ2	0.310 (0.683)
				ISO M20 x 1.5	ZCKJ2H29	0.310 (0.683)
	N/C + N/O break before make, slow break (XE2N P2151)		⊕	1/2" NPT	ZCKJ5	0.310 (0.683)
				ISO M20 x 1.5	ZCKJ5H29	0.310 (0.683)
	N/C + N/O make before make, slow break (XE2N P2161)		⊕	1/2" NPT	ZCKJ6	0.310 (0.683)
ISO M20 x 1.5				ZCKJ6H29	0.310 (0.683)	
N/C + N/C simultaneous, slow break (XE2N P2141)		⊕	1/2" NPT	ZCKJ7	0.310 (0.683)	
			ISO M20 x 1.5	ZCKJ7H29	0.310 (0.683)	
N/O + N/O simultaneous, slow break (XE2N P2131)		-	1/2" NPT	ZCKJ8	0.310 (0.683)	
			ISO M20 x 1.5	ZCKJ8H29	0.310 (0.683)	
N/C + N/C snap action (XE2S P2141)		⊕	1/2" NPT	ZCKJ9	0.310 (0.683)	
			ISO M20 x 1.5	ZCKJ9H29	0.310 (0.683)	
2 step	2 C/O staggered, snap action (XES P2031)		-	1/2" NPT	ZCKJ4	0.310 (0.683)
				ISO M20 x 1.5	ZCKJ4H29	0.310 (0.683)
Fixed bodies with 3-pole contact						
Type	With contact block	Function diagram	Positive operation (1)	Cable entry	Catalog number	Weight kg (lb)
-	N/C + N/O + N/O snap action (XE3S P2151)		⊕	1/2" NPT	ZCKJD31	0.310 (0.683)
				ISO M20 x 1.5	ZCKJD31H29	0.310 (0.683)
	N/C + N/C + N/O snap action (XE3S P2141)		⊕	1/2" NPT	ZCKJD39	0.310 (0.683)
				ISO M20 x 1.5	ZCKJD39H29	0.310 (0.683)
N/C + N/C + N/O break before make, slow break (XE3N P2141)		⊕	1/2" NPT	ZCKJD37	0.310 (0.683)	
			ISO M20 x 1.5	ZCKJD37H29	0.310 (0.683)	
N/C + N/O + N/O break before make, slow break (XE3N P2151)		⊕	1/2" NPT	ZCKJD35	0.310 (0.683)	
			ISO M20 x 1.5	ZCKJD35H29	0.310 (0.683)	

1. ⊕: N/C contact with positive opening operation, when properly mounted and using a conforming operator.



# Limit Switches

## Osiswitch® Classic, Metal, Conforming to CENELEC EN 50041

### XCKJ—Modular, Fixed Non-plug-in or Plug-in Bodies with 1/2" NPT Cable Entry

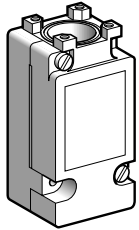

ZCKJ1

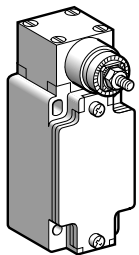

ZCKJ404

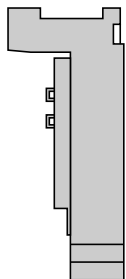

ZCKJ0\*

Plug-in bodies with contact						
Type	With contact block	Function diagram	Positive operation (1)	Cable entry	Catalog number	Weight kg (lb)
1 step	Single-pole C/O snap action		—	1/2" NPT	ZCKJ11	0.300 (0.661)
				ISO M20 x 1.5	ZCKJ11H29	0.300 (0.661)
	Double-pole 2 C/O simultaneous, snap action		—	1/2" NPT	ZCKJ21	0.300 (0.661)
				ISO M20 x 1.5	ZCKJ21H29	0.300 (0.661)
2 step	Double-pole 2 C/O staggered, snap action		—	1/2" NPT	ZCKJ41	0.300 (0.661)
				ISO M20 x 1.5	ZCKJ41H29	0.300 (0.661)
Bodies with contact, with rotary head (without operating lever)						
Type	With contact block	Function diagram	Positive operation (1)	Cable entry	Catalog number	Weight kg (lb)
<b>Fixed non-plug-in body</b>						
Neutral position 1 from the left AND 1 from the right	One SPDT contact switch per direction: past 20° CW contact 1 (11–12 / 13–14) switches; past 20° CCW contact 2 (21–22 / 23–24) switches		—	1/2" NPT	ZCKJ404	0.455 (1.003)
				ISO M20 x 1.5	ZCKJ404H29	0.455 (1.003)
<b>Plug-in body</b>						
Neutral position 1 from the left AND 1 from the right	One SPDT contact switch per direction: past 20° CW contact 1 (11–12 / 13–14) switches; past 20° CCW contact 2 (21–22 / 23–24) switches		—	1/2" NPT	ZCKJ4104	0.465 (1.025)
				ISO M20 x 1.5	ZCKJ4104H29	0.465 (1.025)
Plug-in housing switch top only						
Description	For use with	Contacts	Catalog number	Weight kg (lb)		
Single-pole 1 C/O with positive opening operation	ZCKJ11	Silver	ZCKJ01	0.150 (0.331)		
Double-pole 2 C/O simultaneous with positive opening operation	ZCKJ21	Silver	ZCKJ02	0.160 (0.353)		
Double-pole 1 C/O + 1 C/O neutral position	ZCKJ41	Silver	ZCKJ04	0.160 (0.353)		

1. ⤴: N/C contact with positive opening operation, when properly mounted and using a conforming operator.

# Limit Switches

## Osiswitch® Classic, Metal, Conforming to CENELEC EN 50041

### XCKJ—Modular, Fixed Non-plug-in or Plug-in Bodies with 1/2" NPT Cable Entry

#### With Indicator Light Module

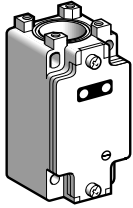

Fixed non-plug-in bodies with 2-pole contact						
Type	With contact block	Function diagram	Positive operation (1)	Cable entry	Catalog number	Weight kg (lb)
<b>With module comprising 1 LED, 24 V<sub>DC</sub></b>						
1 step	N/C + N/O snap action (XE2S P2151)		⊕	1/2" NPT	ZCKJ120	0.320 (0.705)
	N/C + N/O break before make, slow break (XE2N P2151)		⊕	1/2" NPT	ZCKJ520	0.320 (0.705)
<b>With module comprising 2 LEDs, 24 V<sub>DC</sub></b>						
1 step	N/C + N/O snap action (XE2S P2151)		⊕	1/2" NPT	ZCKJ121	0.320 (0.705)
				ISO M20 x 1.5	ZCKJ121H29	0.320 (0.705)
	N/C + N/O break before make, slow break (XE2N P2151)		⊕	1/2" NPT	ZCKJ521	0.320 (0.705)
				ISO M20 x 1.5	ZCKJ521H29	0.320 (0.705)
<b>With module comprising 2 neon indicator lights, 110/120 V<sub>AC</sub></b>						
1 step	N/C + N/O snap action (XE2S P2151)		⊕	1/2" NPT	ZCKJ133	0.320 (0.705)
				ISO M20 x 1.5	ZCKJ133H29	0.320 (0.705)
	N/C + N/O break before make, slow break (XE2N P2151)		⊕	1/2" NPT	ZCKJ533	0.320 (0.705)
				ISO M20 x 1.5	ZCKJ533H29	0.320 (0.705)
<b>With module comprising 2 neon indicator lights, 220/240 V<sub>AC</sub></b>						
1 step	N/C + N/O snap action (XE2S P2151)		⊕	1/2" NPT	ZCKJ134	0.320 (0.705)
				ISO M20 x 1.5	ZCKJ134H29	0.320 (0.705)
	N/C + N/O break before make, slow break (XE2N P2151)		⊕	1/2" NPT	ZCKJ534	0.320 (0.705)
				ISO M20 x 1.5	ZCKJ534H29	0.320 (0.705)
<b>Plug-in bodies with single-pole contact</b>						
Type	With contact block	Function diagram	Positive operation (1)	Cable entry	Catalog number	Weight kg (lb)
<b>With module comprising 2 LEDs, 24 V<sub>DC</sub></b>						
1 step	C/O snap action		—	1/2" NPT	ZCKJ1121	0.340 (0.750)
				ISO M20 x 1.5	ZCKJ1121H29	0.340 (0.750)
<b>With module comprising 2 neon indicator lights, 110/120 V<sub>AC</sub></b>						
1 step	C/O snap action		—	1/2" NPT	ZCKJ1133	0.340 (0.750)
				ISO M20 x 1.5	ZCKJ1133H29	0.340 (0.750)
<b>With module comprising 2 neon indicator lights, 220/240 V<sub>AC</sub></b>						
1 step	C/O snap action		—	1/2" NPT	ZCKJ1134	0.340 (0.750)
				ISO M20 x 1.5	ZCKJ1134H29	0.340 (0.750)

1. ⊕: N/C contact with positive opening operation, when properly mounted and using a conforming operator.

#### Indicator light module characteristics

Type of indicator	1 LED or 2 LEDs	2 neon lights	
Rated insulation voltage	50 V <sub>DC</sub> , conforming to IEC 60947-1	250 V <sub>AC</sub> , conforming to IEC 60947-1	
Current consumption	7 mA per LED	2.5 mA per neon	5 mA per neon
Rated operational voltage	24 V <sub>DC</sub>	110/120 V <sub>AC</sub>	220/240 V <sub>AC</sub>
Voltage limits	20...30 V <sub>DC</sub> (including ripple)	95...130 V <sub>AC</sub>	190...260 V <sub>AC</sub>
Service life	100 000 hours	20 000 hours	20 000 hours
Reverse polarity protection	Yes	—	

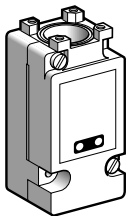

# Limit Switches

## Osiswitch® Classic, Metal, Conforming to CENELEC EN 50041

### XCKJ—Modular, Fixed Non-plug-in Bodies with M12 Connector

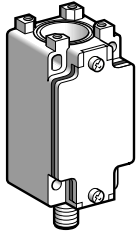

Fixed bodies with 2-pole contact					
Type	With contact block	Function diagram	Positive operation (1)	Catalog number	Weight kg (lb)
1 step	N/C + N/O snap action (XE2S P2151)		⊕	ZCKJ1D	0.320 (0.705)
	N/C + N/O break before make, slow break (XE2N P2151)		⊖	ZCKJ5D	0.320 (0.705)
	N/O + N/C make before make, slow break (XE2N P2161)		⊕	ZCKJ6D	0.320 (0.705)
	N/C + N/C simultaneous, slow break (XE2N P2141)		⊖	ZCKJ7D	0.320 (0.705)
	N/O + N/O simultaneous, slow break (XE2N P2131)		—	ZCKJ8D	0.320 (0.705)

1. N/C contact with positive opening operation, when properly mounted and using a conforming operator.

# Limit Switches

## Osiswitch® Classic, Metal, Conforming to CENELEC EN 50041

### XCKJ—Modular, Fixed Non-plug-in or Plug-in Bodies with 1/2" NPT Cable Entry

#### Low-Temperature Applications (–40 °F / –40 °C)

#### Body with contacts—For plunger or rotary head

Type	Contact block	Function diagram	Positive operation (1)	Cable entry	Catalog number	Weight kg (lb)
<b>Fixed non-plug-in body</b>						
1 step	2-pole 1 N/C + 1 N/O snap action (XE2SP2151)		⊕	1/2" NPT	ZCKJ1	0.310 (0.683)
				ISO M20 x 1.5	ZCKJ1H29	0.310 (0.683)
	Double-pole 2 C/O simultaneous snap action (XESP2021)		—	1/2" NPT	ZCKJ2	0.310 (0.683)
				ISO M20 x 1.5	ZCKJ2H29	0.310 (0.683)
	2-pole 1 N/C + 1 N/O break before make slow break (XE2NP2151)		⊕	1/2" NPT	ZCKJ5	0.310 (0.683)
				ISO M20 x 1.5	ZCKJ5H29	0.310 (0.683)
	2-pole 1 N/O + 1 N/C make before break slow break (XE2NP2161)		⊕	1/2" NPT	ZCKJ6	0.310 (0.683)
				ISO M20 x 1.5	ZCKJ6H29	0.310 (0.683)
	2-pole 1 N/C + 1 N/C simultaneous slow break (XE2NP2141)		⊕	1/2" NPT	ZCKJ7	0.310 (0.683)
				ISO M20 x 1.5	ZCKJ7H29	0.310 (0.683)
	2-pole 1 N/O + 1 N/O simultaneous slow break (XE2NP2131)		—	1/2" NPT	ZCKJ8	0.310 (0.683)
				ISO M20 x 1.5	ZCKJ8H29	0.310 (0.683)
2-pole 1 N/C + 1 N/C snap action (XE2SP2141)		⊕	1/2" NPT	ZCKJ9	0.310 (0.683)	
			ISO M20 x 1.5	ZCKJ9H29	0.310 (0.683)	
2 step	Double-pole 2 C/O staggered snap action (XESP2031)		—	1/2" NPT	ZCKJ4	0.310 (0.683)
				ISO M20 x 1.5	ZCKJ4H29	0.310 (0.683)
<b>Plug-in body</b>						
1 step	Single-pole 1 C/O snap action		—	1/2" NPT	ZCKJ11	0.300 (0.661)
				ISO M20 x 1.5	ZCKJ11H29	0.300 (0.661)
	Double-pole 2 C/O simultaneous snap action		—	1/2" NPT	ZCKJ21	0.300 (0.661)
				ISO M20 x 1.5	ZCKJ21H29	0.300 (0.661)
2 step	Double-pole 2 C/O staggered snap action		—	1/2" NPT	ZCKJ41	0.300 (0.661)
				ISO M20 x 1.5	ZCKJ41H29	0.300 (0.661)
<b>Body with contacts—With spring return rotary head (without operating lever)</b>						
<b>Fixed non-plug-in body</b>						
Neutral position 1 from the left and 1 from the right	Double-pole 2 C/O staggered snap action		—	1/2" NPT	ZCKJ4046	0.455 (1.003)
				ISO M20 x 1.5	ZCKJ4046H29	0.455 (1.003)
<b>Plug-in body</b>						
Neutral position 1 from the left and 1 from the right	Double-pole 2 C/O staggered snap action		—	1/2" NPT	ZCKJ41046	0.465 (1.025)
				ISO M20 x 1.5	ZCKJ41046H29	0.465 (1.025)

1. ⊕: Operating head able to guarantee positive opening operation, when properly mounted and using a conforming operator. The positive opening feature requires additional travel past the trip point. See the contact function diagrams.

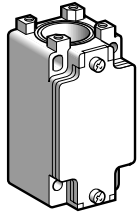

ZCKJ1

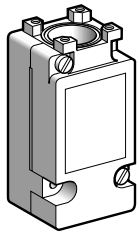

ZCKJ11

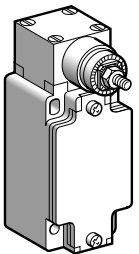

ZCKJ4046

# Limit Switches

## Osiswitch® Classic, Metal, Conforming to CENELEC EN 50041

### XCKJ—Modular, Fixed Non-plug-in or Plug-in Bodies with 1/2" NPT Cable Entry

#### Low-Temperature Applications (−40 °F / −40 °C)

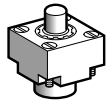

ZCKE616

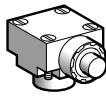

ZCKE636

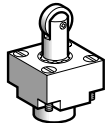

ZCKE626

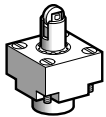

ZCKE676

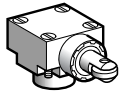

ZCKE646

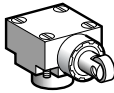

ZCKE656

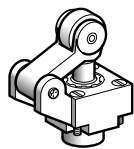

ZCKE216

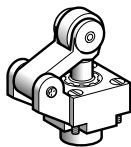

ZCKE236

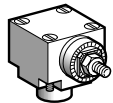

ZCKE056

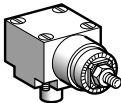

ZCKE096

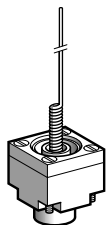

ZCKE066

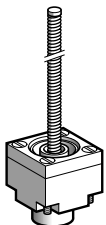

ZCKE086

Plunger heads						
Type of operator	Compatible bodies	Max. actuation speed	Positive operation (1)	Catalog number	Weight kg (lb)	
<b>For actuation on end</b>						
<b>End plunger</b> metal	ZCKJ*, ZCKJ**	0.5 m/s (1.64 ft/s)	⊖	<b>ZCKE616</b>	0.140 (0.309)	
<b>Side plunger</b> metal	ZCKJ*, ZCKJ**, except ZCKJ4 and J41	0.5 m/s (1.64 ft/s)	⊖	<b>ZCKE636</b>	0.200 (0.441)	
<b>For actuation by 30° cam</b>						
<b>End roller plunger</b> steel	ZCKJ*, ZCKJ**	1 m/s (3.28 ft/s)	⊖	<b>ZCKE626</b>	0.155 (0.342)	
<b>End reinforced roller plunger</b> steel	ZCKJ*, ZCKJ**	1 m/s (3.28 ft/s)	⊖	<b>ZCKE676</b>	0.155 (0.342)	
<b>Side roller plunger</b> steel	Horizontal	ZCKJ*, ZCKJ**, except ZCKJ4 and J41	0.6 m/s (1.97 ft/s)	⊖	<b>ZCKE646</b>	0.205 (0.452)
	Vertical	ZCKJ*, ZCKJ**, except ZCKJ4 and J41	0.6 m/s (1.97 ft/s)	⊖	<b>ZCKE656</b>	0.205 (0.452)
<b>Roller lever plunger</b> (1 direction of actuation)	Thermoplastic	ZCKJ*, ZCKJ**	1.5 m/s (4.92 ft/s)	⊖	<b>ZCKE216</b>	0.185 (0.408)
	Steel	ZCKJ*, ZCKJ**	1.5 m/s (4.92 ft/s)	⊖	<b>ZCKE236</b>	0.195 (0.430)
<b>Rotary heads (without operating lever)</b>						
Type	Compatible bodies	Max. actuation speed	Positive operation (1)	Catalog number	Weight kg (lb)	
<b>Spring return,</b> actuation from left <b>AND</b> right or from left <b>OR</b> right (see page 20)	ZCKJ*, ZCKJ**	1.5 m/s (4.92 ft/s) by 30° cam	⊖	<b>ZCKE056</b>	0.165 (0.364)	
<b>Stay put,</b> actuation from left <b>AND</b> right (see page 20)	ZCKJ1, J11 ZCKJ2, J21	1.5 m/s (4.92 ft/s)	—	<b>ZCKE096</b>	0.190 (0.419)	
<b>Multi-directional heads</b>						
Type of operator	Compatible bodies	Max. actuation speed	Positive operation (1)	Catalog number	Weight kg (lb)	
<b>For actuation by any moving part</b>						
<b>"Cat's whisker"</b>	ZCKJ*, ZCKJ**, except ZCKJ4 and ZCKJ41	1 m/s (3.28 ft/s) in any direction	—	<b>ZCKE066</b>	0.115 (0.254)	
<b>Spring rod lever</b>	ZCKJ*, ZCKJ**, except ZCKJ4 and ZCKJ41	0.5 m/s (1.64 ft/s) in any direction	—	<b>ZCKE086</b>	0.125 (0.276)	

1. ⊖ : Operating head able to guarantee positive opening operation, when properly mounted and using a conforming operator. The positive opening feature requires additional travel past the trip point. See the contact function diagrams.

# Limit Switches

## Osiswitch® Classic, Metal, Conforming to CENELEC EN 50041

### XCKJ—Modular, Fixed Non-plug-in or Plug-in Bodies with 1/2" NPT Cable Entry

#### Low-Temperature Applications (−40 °F / −40 °C)

#### Operating levers for rotary heads

Description	Positive operation (1)	Catalog number	Weight kg (lb)
<b>For actuation by 30° cam</b>			
<b>Roller lever (2)</b>	Thermoplastic	ZCKY11	0.025 (0.055)
	Steel	ZCKY13	0.035 (0.077)
	Steel, ball bearing mounted	ZCKY14	0.030 (0.066)
<b>Variable length roller lever (3)</b>	Thermoplastic	ZCKY41	0.030 (0.066)
	Steel	ZCKY43	0.040 (0.088)

#### For actuation by any moving part

<b>Square rod (2)</b>	∅ 3 mm (0.12 in.) steel, L = 125 mm (4.92 in.)	ZCKY51	0.025 (0.055)
<b>Round rod (2)</b>	∅ 3 mm (0.12 in.) steel, L = 125 mm (4.92 in.)	ZCKY53	0.025 (0.055)
	∅ 3 mm (0.12 in.) glass fibre, L = 125 mm (4.92 in.)	ZCKY52	0.020 (0.044)
	∅ 6 mm (0.24 in.) thermoplastic, L = 200 mm (7.87 in.)	ZCKY59	0.030 (0.066)

<b>Spring lever (3)</b>		ZCKY81	0.020 (0.044)
-------------------------	--	--------	---------------

<b>Spring metal rod lever (3)</b>		ZCKY91	0.025 (0.055)
-----------------------------------	--	--------	---------------

#### For actuation by specific cam (for operation with ZCK-E096 head)

<b>Forked arm and rollers (2) thermoplastic</b>	1 track	ZCKY71	0.035 (0.077)
	2 track	ZCKY61	0.035 (0.077)

#### 2- or double-pole contact blocks

Type	Function diagram	For body type	Positive operation (1)	Catalog number	Weight kg (lb)
<b>1 N/C + 1 N/O snap action</b>		ZCKJ1	⊕	XE2SP2151	0.020 (0.044)
<b>1 N/C + 1 N/O break before make slow break</b>		ZCKJ5	⊕	XE2NP2151	0.020 (0.044)
<b>2 C/O simultaneous snap action</b>		ZCKJ2	—	XESP2021	0.045 (0.099)
<b>2 C/O staggered snap action</b>		ZCKJ4	—	XESP2031	0.045 (0.099)
<b>1 N/O + 1 N/C make before break slow break</b>		ZCKJ6	⊕	XE2NP2161	0.020 (0.044)
<b>1 N/C + 1 N/C simultaneous slow break</b>		ZCKJ7	⊕	XE2NP2141	0.020 (0.044)
<b>1 N/O + 1 N/O simultaneous slow break</b>		ZCKJ8	—	XE2NP2131	0.020 (0.044)
<b>1 N/C + 1 N/C snap action</b>		ZCKJ9	⊕	XE2SP2141	0.020 (0.044)

- ⊕ : Operating lever able to guarantee positive opening operation, when properly mounted and using a conforming operator, or N/C contact with positive opening operation. The positive opening feature requires additional travel past the trip point. See the contact function diagrams.
- Adjustable throughout 360° in 5° steps, or in 45° steps by reversing the lever mounting or clamp.
- Adjustable throughout 360° in 5° steps.

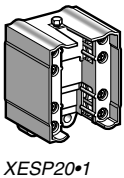
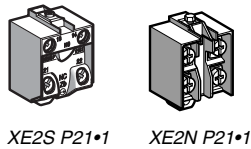
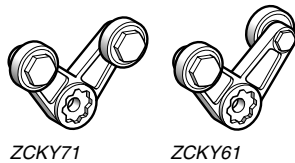
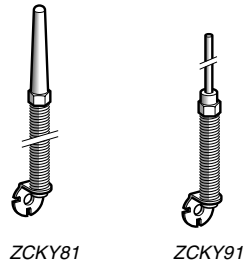
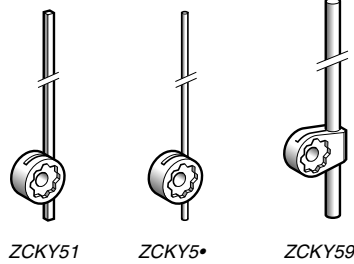
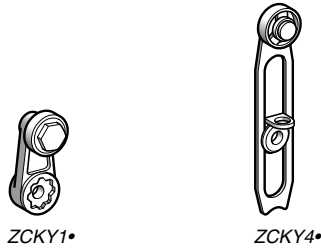

# Limit Switches

## Osiswitch® Classic, Metal, Conforming to CENELEC EN 50041

### XCKJ—Modular, Fixed Non-plug-in or Plug-in Bodies with 1/2" NPT Cable Entry

#### High-Temperature Applications (+248 °F /+120 °C)

##### Body with contacts—For plunger or rotary head

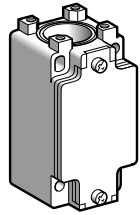

ZCKJ

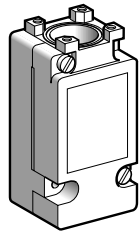

ZCKJ15

Type	Contact block	Function diagram	Positive operation (1)	Cable entry	Catalog number	Weight kg (lb)
<b>Fixed body</b>						
<b>1 step</b>	2-pole 1 N/C + 1 N/O snap action (XE2SP2151)		⊕	1/2" NPT	ZCKJ1	0.310 (0.683)
				ISO M20 x 1.5	ZCKJ1H29	0.310 (0.683)
	Double-pole 2 C/O simultaneous snap action (XESP20215)		—	1/2" NPT	ZCKJ25	0.310 (0.683)
				ISO M20 x 1.5	ZCKJ25H29	0.310 (0.683)
	2-pole 1 N/C + 1 N/O break before make slow break (XE2NP2151)		⊕	1/2" NPT	ZCKJ5	0.310 (0.683)
				ISO M20 x 1.5	ZCKJ5H29	0.310 (0.683)
	2-pole 1 N/O + 1 N/C make before break slow break (XE2NP2161)		⊕	1/2" NPT	ZCKJ6	0.310 (0.683)
				ISO M20 x 1.5	ZCKJ6H29	0.310 (0.683)
	2-pole 1 N/C + 1 N/C slow break (XE2NP2141)		⊕	1/2" NPT	ZCKJ7	0.310 (0.683)
				ISO M20 x 1.5	ZCKJ7H29	0.310 (0.683)
	2-pole 1 N/O + 1 N/O simultaneous slow break (XE2NP2131)		—	1/2" NPT	ZCKJ8	0.310 (0.683)
				ISO M20 x 1.5	ZCKJ8H29	0.310 (0.683)
2-pole 1 N/C + 1 N/C snap action (XE2SP2141)		⊕	1/2" NPT	ZCKJ9	0.310 (0.683)	
			ISO M20 x 1.5	ZCKJ9H29	0.310 (0.683)	
<b>2 step</b>	Double-pole 2 C/O break before make snap action (XESP20315)		—	1/2" NPT	ZCKJ45	0.310 (0.683)
				ISO M20 x 1.5	ZCKJ45H29	0.310 (0.683)
<b>Plug-in body</b>						
<b>1 step</b>	Single-pole 1 C/O snap action		—	1/2" NPT	ZCKJ115	0.300 (0.661)
				ISO M20 x 1.5	ZCKJ115H29	0.300 (0.661)
	Double-pole 2 C/O simultaneous snap action		—	1/2" NPT	ZCKJ215	0.300 (0.661)
				ISO M20 x 1.5	ZCKJ215H29	0.300 (0.661)
<b>2 step</b>	Double-pole 2 C/O break before make snap action		—	1/2" NPT	ZCKJ415	0.300 (0.661)
				ISO M20 x 1.5	ZCKJ415H29	0.300 (0.661)
<b>Body with contacts—With spring return rotary head (without operating lever)</b>						
<b>Fixed body</b>						
<b>2 step</b> 1 from the left AND 1 from the right	Double-pole 2 C/O break before make snap action		—	1/2" NPT	ZCKJ4045	0.455 (1.003)
				ISO M20 x 1.5	ZCKJ4045H29	0.455 (1.003)
<b>Plug-in body</b>						
<b>2 step</b> 1 from the left AND 1 from the right	Double-pole 2 C/O break before make snap action		—	1/2" NPT	ZCKJ41045	0.465 (1.025)
				ISO M20 x 1.5	ZCKJ41045H29	0.465 (1.025)

1. ⊕ : Operating head able to guarantee positive opening operation, when properly mounted and using a conforming operator. The positive opening feature requires additional travel past the trip point. See the contact function diagrams.

Setup:  
page 120

Dimensions:  
page 122

# Limit Switches

## Osiswitch® Classic, Metal, Conforming to CENELEC EN 50041

### XCKJ—Modular, Fixed Non-plug-in or Plug-in Bodies with 1/2" NPT Cable Entry

#### High-Temperature Applications (+248 °F /+120 °C)

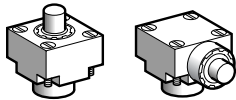

ZCKE615 ZCKE635

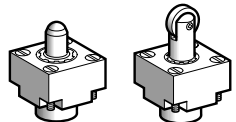

ZCKE665 ZCKE625

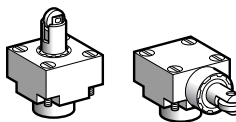

ZCKE675 ZCKE645

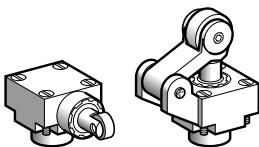

ZCKE655 ZCKE235

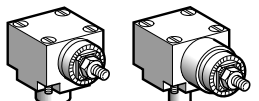

ZCKE055 ZCKE095

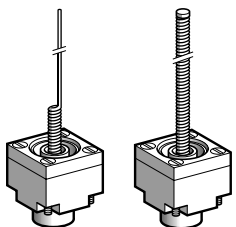

ZCKE065 ZCKE085

Plunger heads						
Type of operator		Compatible bodies	Max. actuation speed	Positive operation (1)	Catalog number	Weight kg (lb)
<b>For actuation on end</b>						
<b>End plunger</b>	Metal	ZCKJ1, J2, J4, ZCKJ115, J215, J415, ZCKJ5, J6, J7, J8, J9	0.5 m/s (1.64 ft/s)	⊖	ZCKE615	0.140 (0.309)
<b>Side plunger</b>	Metal	ZCKJ1, J2, ZCKJ115, J215, ZCKJ5, J6, J7, J8, J9	0.5 m/s (1.64 ft/s)	⊖	ZCKE635	0.200 (0.441)
<b>For actuation by 30° cam</b>						
<b>End ball bearing plunger</b>	Steel	ZCKJ1, J2, J4, ZCKJ115, J215, J415, ZCKJ5, J6, J7, J8, J9	0.1 m/s (0.33 ft/s)	⊖	ZCKE665	0.150 (0.331)
<b>End roller plunger</b>	Steel	ZCKJ1, J2, J4, ZCKJ115, J215, J415, ZCKJ5, J6, J7, J8, J9	1 m/s (3.28 ft/s)	⊖	ZCKE625	0.155 (0.342)
<b>End reinforced roller plunger</b>	Steel	ZCKJ1, J2, J4, ZCKJ115, J215, J415, ZCKJ5, J6, J7, J8, J9	1 m/s (3.28 ft/s)	⊖	ZCKE675	0.155 (0.342)
<b>Side roller plunger</b>	Steel Horizontal	ZCKJ1, J2, ZCKJ115, J215, ZCKJ5, J6, J7, J8, J9	0.6 m/s (1.97 ft/s)	⊖	ZCKE645	0.205 (0.452)
	Steel Vertical	ZCKJ1, J2, ZCKJ115, J215, ZCKJ5, J6, J7, J8, J9	0.6 m/s (1.97 ft/s)	⊖	ZCKE655	0.205 (0.452)
<b>Roller lever plunger</b> (1 direction of actuation)	Steel	ZCKJ1, J2, J4, ZCKJ115, J215, J415, ZCKJ5, J6, J7, J8, J9	1.5 m/s (4.92 ft/s)	⊖	ZCKE235	0.195 (0.430)
	Thermoplastic	ZCKJ1, J2, J4, ZCKJ115, J215, J415, ZCKJ5, J6, J7, J8, J9	1.5 m/s (4.92 ft/s)	⊖	ZCKE215	0.185 (0.408)
Rotary heads (without operating lever)						
Type		Compatible bodies	Max. actuation speed	Positive operation (1)	Catalog number	Weight kg (lb)
<b>Spring return,</b> actuation from left AND right or from left OR right (see page 20)		ZCKJ1, J2, J4, ZCKJ115, J215, ZCKJ415, ZCKJ5, J6, J7, J8, J9	1.5 m/s (4.92 ft/s) by 30° cam	⊖	ZCKE055	0.165 (0.364)
<b>Stay put,</b> actuation from left AND right (see page 20)		ZCKJ1, J2, ZCKJ115, J215	0.5 m/s (1.64 ft/s)	—	ZCKE095	0.190 (0.419)
Multi-directional heads						
Type of operator		Compatible bodies	Max. actuation speed	Positive operation (1)	Catalog number	Weight kg (lb)
<b>For actuation by any moving part</b>						
<b>"Cat's whisker"</b>		ZCKJ1, J2, ZCKJ115, J215, ZCKJ5, J6, J7, J8, J9	1 m/s (3.28 ft/s) in any direction	—	ZCKE065	0.115 (0.254)
<b>Spring rod lever</b>		ZCKJ1, J2, ZCKJ115, J215, ZCKJ5, J6, J7, J8, J9	0.5 m/s (1.64 ft/s) in any direction	—	ZCKE085	0.125 (0.276)

1. ⊖ : Operating head able to guarantee positive opening operation, when properly mounted and using a conforming operator. The positive opening feature requires additional travel past the trip point. See the contact function diagrams.



# Limit Switches

## Osiswitch® Classic, Metal, Conforming to CENELEC EN 50041

### XCKJ—Modular, Fixed Non-plug-in or Plug-in Bodies with 1/2" NPT Cable Entry

#### High-Temperature Applications (+248 °F /+120 °C)

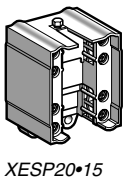
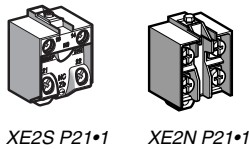
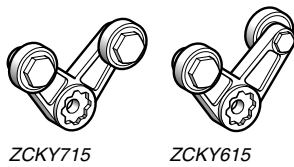
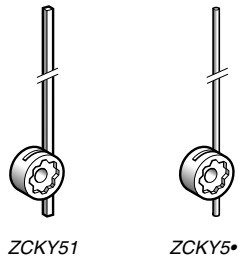
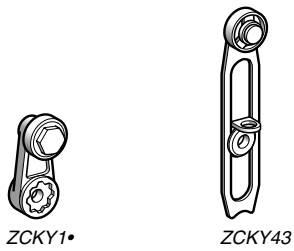

Operating levers for rotary heads					
Description		Positive operation (1)	Catalog number	Weight kg (lb)	
<b>For actuation by 30° cam</b>					
Roller lever (2)	Thermoplastic	⊕	ZCKY115	0.025 (0.055)	
	Steel	⊕	ZCKY13	0.035 (0.077)	
	Steel, ball bearing mounted	⊕	ZCKY14	0.030 (0.066)	
Variable length roller lever (3)	Thermoplastic	—	ZCKY415	0.030 (0.066)	
	Steel	—	ZCKY43	0.040 (0.088)	
<b>For actuation by any moving part</b>					
Square rod (2)	∅ 3 mm (0.12 in.) Steel, L = 125 mm (4.92 in.)	—	ZCKY51	0.025 (0.055)	
Round rod (2)	∅ 3 mm (0.12 in.) steel, L = 125 mm (4.92 in.)	—	ZCKY53	0.025 (0.055)	
	∅ 3 mm (0.12 in.) glass fibre, L = 125 mm (4.92 in.)	—	ZCKY52	0.020 (0.044)	
<b>For actuation by specific cam (for operation with ZCK-E095 head only)</b>					
Forked arm and rollers (2) thermoplastic	1 track	—	ZCKY715	0.035 (0.077)	
	2 track	—	ZCKY615	0.035 (0.077)	
<b>2- or double-pole contact blocks</b>					
Type of operator	Function diagram	For body type	Positive operation (1)	Catalog number	Weight kg (lb)
1 N/C + 1 N/O snap action		ZCKJ1	⊕	XE2SP2151	0.020 (0.044)
1 N/C + 1 N/O break before make slow break		ZCKJ5	⊕	XE2NP2151	0.020 (0.044)
2 C/O simultaneous snap action		ZCKJ25	—	XESP20215	0.045 (0.099)
2 C/O staggered snap action		ZCKJ45	—	XESP20315	0.045 (0.099)
1 N/O + 1 N/C make before break slow break		ZCKJ6	⊕	XE2NP2161	0.020 (0.044)
1 N/C + 1 N/C simultaneous slow break		ZCKJ7	⊕	XE2NP2141	0.020 (0.044)
1 N/O + 1 N/O simultaneous slow break		ZCKJ8	—	XE2NP2131	0.020 (0.044)
1 N/C + 1 N/C snap action		ZCKJ9	⊕	XE2SP2141	0.020 (0.044)

- ⊕ : Operating head able to guarantee positive opening operation, when properly mounted and using a conforming operator. The positive opening feature requires additional travel past the trip point. See the contact function diagrams.
- Adjustable throughout 360° in 5° steps, or in 45° steps by reversing the lever mounting or clamp.
- Adjustable throughout 360° in 5° steps.

# Limit Switches

## Osswitch® Classic, Metal, Conforming to CENELEC EN 50041

### XCKJ—Modular, Fixed Non-plug-in or Plug-in Bodies—Components

Contact blocks					
Type of contact	Function diagram	For bodies	Positive operation (1)	Catalog number	Weight kg (lb)
<b>2-pole contact</b>					
N/C + N/O snap action		ZCKJ1 ZCKJ1D	⊕	XE2S P2151	0.020 (0.044)
N/C + N/O break before make, slow break		ZCKJ5 ZCKJ5D	⊕	XE2N P2151	0.020 (0.044)
2 C/O simultaneous, snap action		ZCKJ2	—	XES P2021	0.045 (0.099)
2 C/O staggered, snap action		ZCKJ4	—	XES P2031	0.045 (0.099)
N/O + N/C make before break, slow break		ZCKJ6 ZCKJ6D	⊕	XE2N P2161	0.020 (0.044)
N/C + N/C simultaneous, slow break		ZCKJ7 ZCKJ7D	⊕	XE2N P2141	0.020 (0.044)
N/O + N/O simultaneous, slow break		ZCKJ8 ZCKJ8D	—	XE2N P2131	0.020 (0.044)
N/C + N/C snap action		ZCKJ9	⊕	XE2S P2141	0.020 (0.044)
<b>3-pole contact</b>					
N/C + N/O + N/O snap action		ZCKJD31	⊕	XE3S P2151	0.035 (0.077)
N/C + N/C + N/O snap action		ZCKJD39	⊕	XE3S P2141	0.035 (0.077)
N/C + N/C + N/O break before make, slow break		ZCKJD37	⊕	XE3N P2141	0.035 (0.077)
N/C + N/O + N/O break before make, slow break		ZCKJD35	⊕	XE3N P2151	0.035 (0.077)

1. ⊕: N/C contact with positive opening operation, when properly mounted and using a conforming operator.

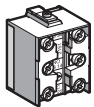
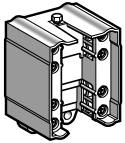
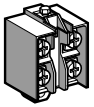

# Limit Switches

## Osiswitch® Classic, Metal, Conforming to CENELEC EN 50041

### XCKJ—Modular, Fixed Non-plug-in or Plug-in Bodies—Components

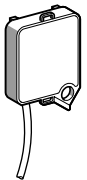
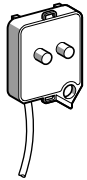
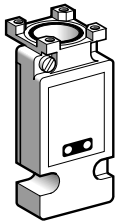
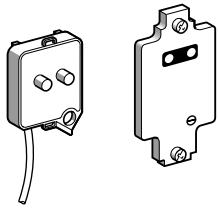

Covers + indicator light module				
For use with	Number and type of indicators	Voltage	Catalog number	Weight kg (lb)
Fixed non-plug-in body	1 LED	24 V $\cdots$	ZCK Z020	0.060 (0.132)
	2 LEDs	24 V $\cdots$	ZCK Z021	0.060 (0.132)
	2 neon lights	110/120 V $\sim$	ZCK Z033	0.060 (0.132)
		220/240 V $\sim$	ZCK Z034	0.060 (0.132)
Plug-in switch-top body with pilot lights	2 LEDs	24 V $\cdots$	ZCKJ0121	0.200 (0.441)
	2 neon lights	110/120 V $\sim$	ZCKJ0133	0.200 (0.441)
		220/240 V $\sim$	ZCKJ0134	0.200 (0.441)
	Indicator light modules			
For use with	Number and type of indicators	Voltage	Catalog number	Weight kg (lb)
Fixed non-plug-in body	1 LED	24 V $\cdots$	ZCKJ902	0.030 (0.066)
	2 LEDs	24 V $\cdots$	ZCKJ906	0.030 (0.066)
	2 neon lights	110/120 V $\sim$	ZCKJ903	0.030 (0.066)
		220/240 V $\sim$	ZCKJ904	0.030 (0.066)
Module with resistor for machine diagnostics				
For use with	Resistor value		Catalog number	Weight kg (lb)
Fixed non-plug-in body (XCKJ1 and ZCKJ1 only)	15 k $\Omega$ , 1/4 W		ZCKJ82A	0.030 (0.066)
Other versions	Covers + indicator light module for other supply voltages. Please consult your local sales office.			

# Limit Switches

## Osiswitch® Classic, Metal, Conforming to CENELEC EN 50041 XCKJ—Modular, Fixed Non-plug-in or Plug-in Bodies—Components

Function diagrams (positive operation assured only if the associated sub-assemblies are ⊕)

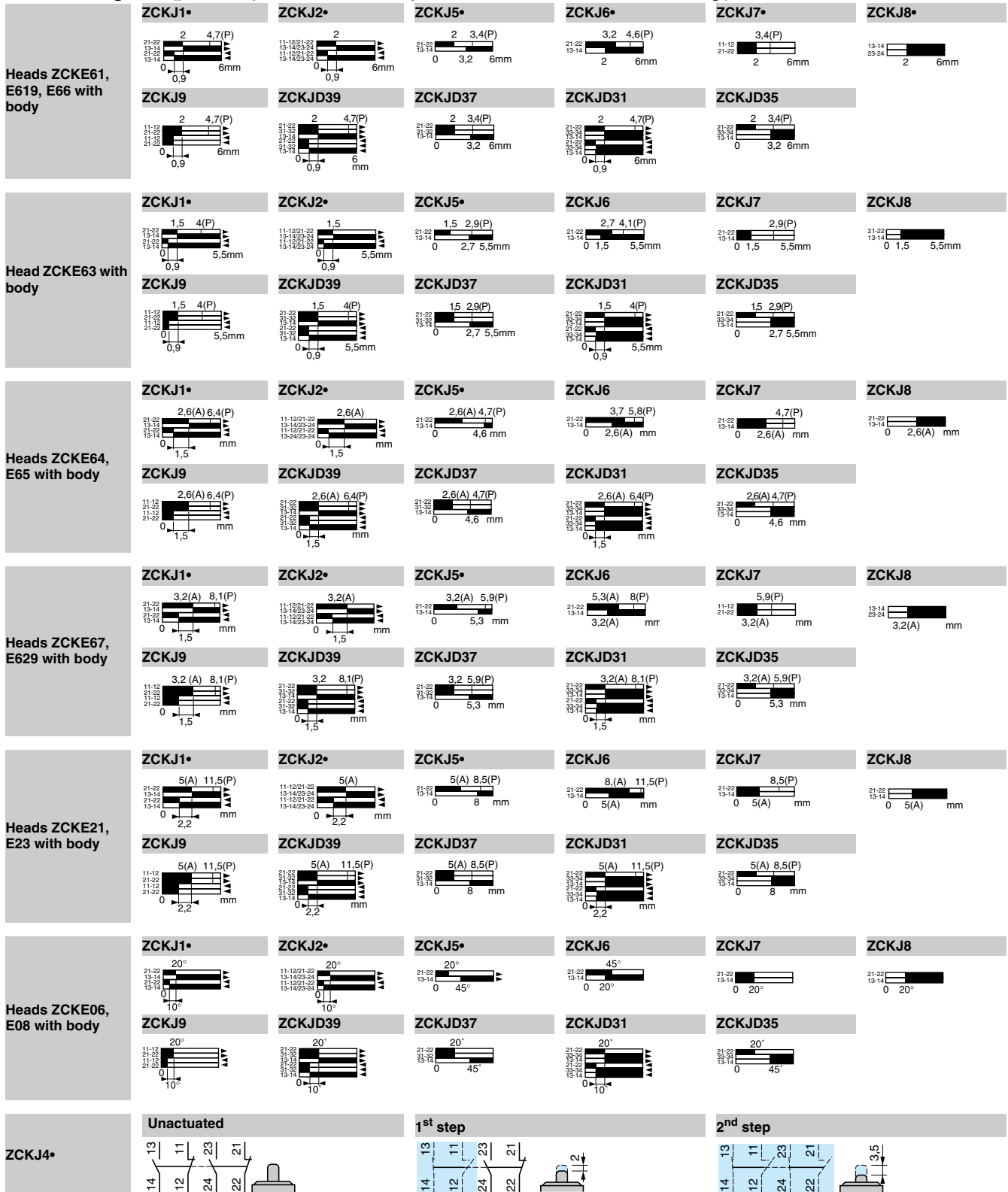

Contact operation

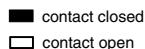

(A) = cam displacement  
(P) = positive opening point

# Limit Switches

## Osiswitch® Classic, Metal, Conforming to CENELEC EN 50041 XCKJ—Modular, Fixed Non-plug-in or Plug-in Bodies—Components

Function diagrams (positive operation assured only if the associated sub-assemblies are ⊖)

Head ZCKE05 with body

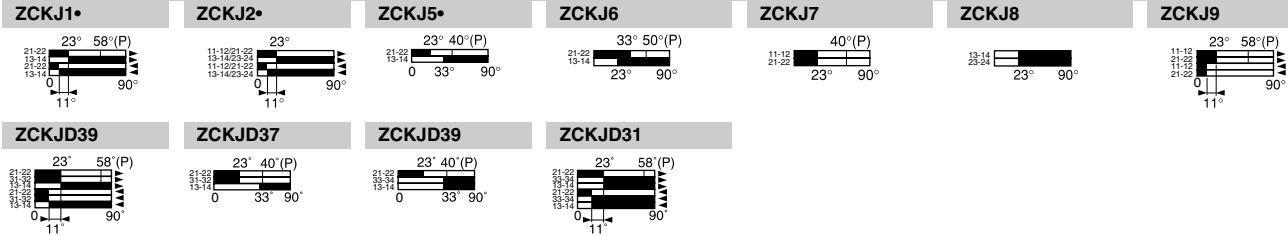

ZCKJ4•

Unactuated

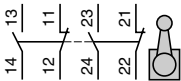

1<sup>st</sup> step, actuated from left or right

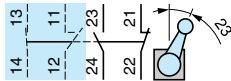

2<sup>nd</sup> step, actuated from left or right

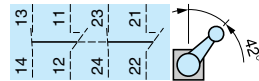

Head ZCKE09 with body

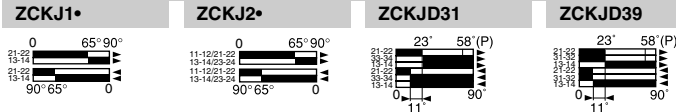

ZCKJ404, J4104 (body with head)

Unactuated

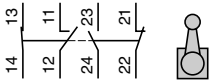

Actuated from left

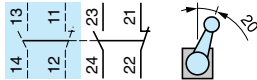

Actuated from right

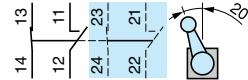

Contact operation

■ contact closed  
□ contact open

(P) = positive opening point

### Wiring diagrams

Indicator light modules

1 LED, 24 V $\overline{\text{DC}}$

2 LEDs, 24 V $\overline{\text{DC}}$

2 neon lights, 110/120 or 220/240 V $\sim$

Module with resistor

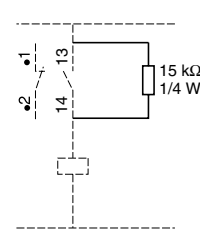
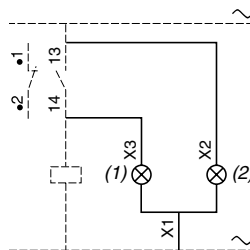
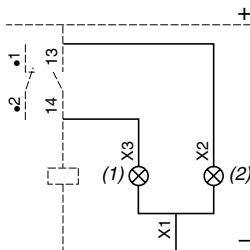
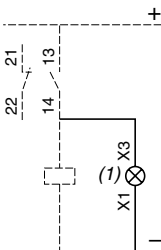

1. Orange indicator
2. Green indicator

ZCKJ•D

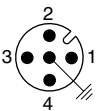

1-2= N/C

3-4= N/O

5= ⊕

4 A / 24 V max.



# Limit Switches

## Osiswitch® Classic, Metal, Conforming to CENELEC EN 50041

### XCKJ—Modular, Fixed Non-plug-in or Plug-in Bodies—Components

#### Bodies

##### Non-plug-in

ZCKJ1, J2, J5, J4, J•2•, J•3•, J6, J7, J8, J9  
ZCKJ1H29, J2H29, J5H29, J4H29, J•2•H29, J•3•H29,  
J6H29, J7H29, J8H29, J9H29

##### Plug-in

ZCKJ11, J21, J41, J11••  
ZCKJ11H29, J21H29, J41H29, J11••H29

##### Non-plug-in

ZCKJ1D, J5D, J6D, J7D, J8D

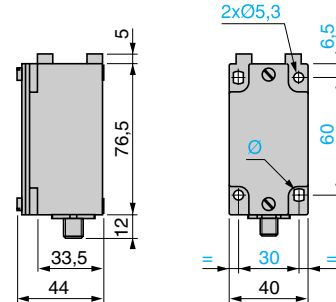
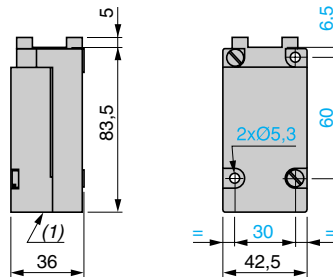
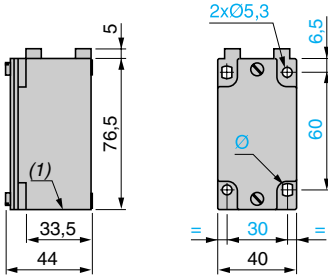

#### Bodies with rotary head mounted

##### Non-plug-in

ZCKJ404, ZCKJ404H29

##### Plug-in

ZCKJ4104, ZCKJ4104H29

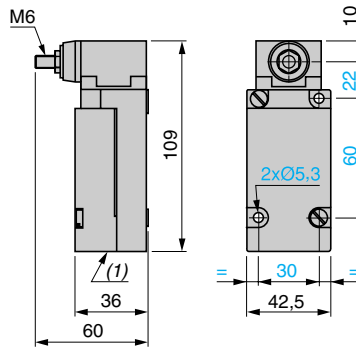
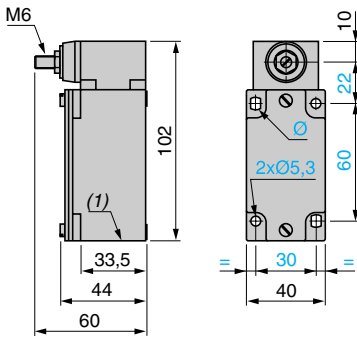

Limit Switches

#### Plunger heads

##### ZCKE61

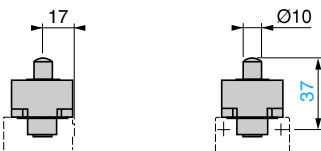

##### ZCKE619

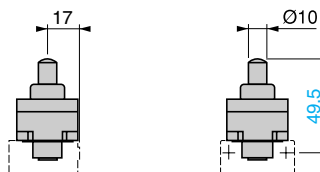

##### ZCKE63

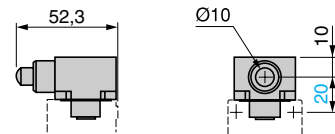

##### ZCKE64

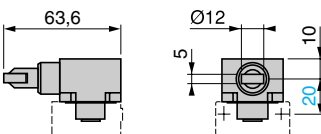

##### ZCKE65

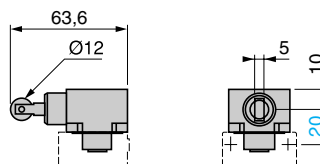

##### ZCKE66

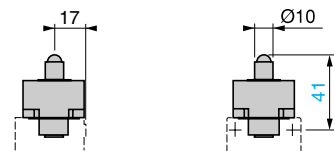

##### ZCKE62, ZCKE67

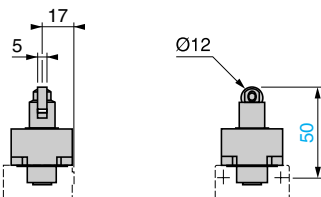

##### ZCKE629

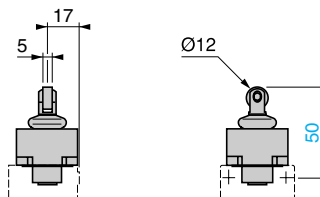

##### ZCKE21, E23

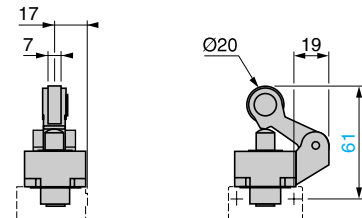

1: 1 tapped entry for 1/2" NPT.  
Ø: 2 elongated holes Ø 5.3 x 7.3.

# Limit Switches

## Osiswitch® Classic, Metal, Conforming to CENELEC EN 50041 XCKJ—Modular, Fixed Non-plug-in or Plug-in Bodies—Components

### Rotary head ZCKE05 with operating lever ZCKY11, Y13, Y14

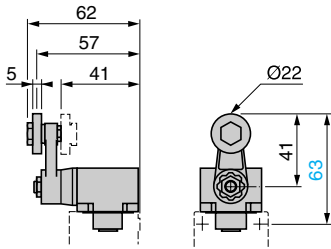

### ZCKY41, Y43

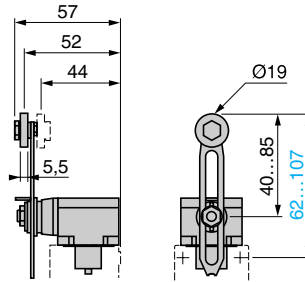

### ZCKY51, Y52, Y53, Y59

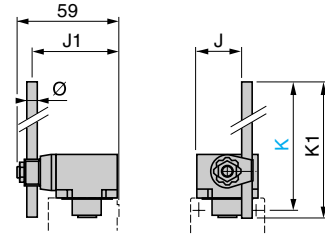

	J	J1	K max	K1	Ø
ZCKY51	20	49	137	123	Ø 3
ZCKY52	20	49	137	125	Ø 3
ZCKY53	20	49	137	125	Ø 3
ZCKY59	26.2	48	212	200	Ø 6

### ZCKY81

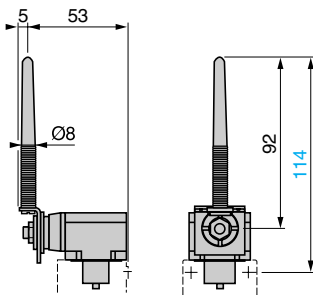

### ZCKY91

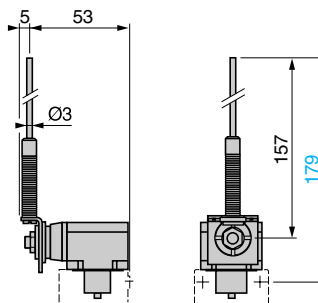

### Rotary head ZCKE09 with operating lever ZCKY61

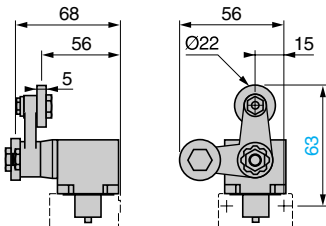

### ZCKY71

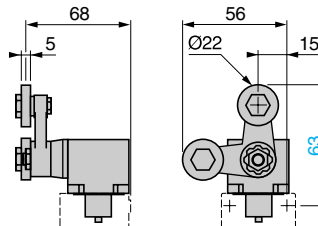

### Multi-directional heads

#### ZCKE06

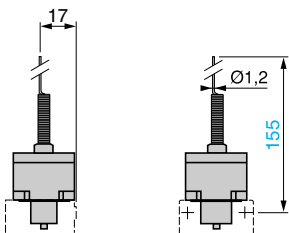

#### ZCKE08

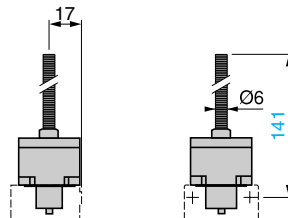

Note: operating lever spindle threaded M6.

# Limit Switches

## Osiswitch® Classic, Plastic, Conforming to CENELEC EN 50041

### XCKS—Double Insulated

■ XCKS  
fixed, non-plug-in body with 1 cable entry

□ With head for linear movement (plunger) operators

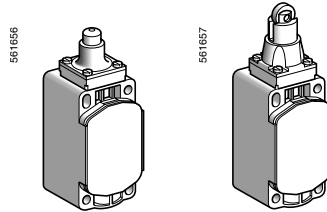

Page 126

□ With head for rotary movement (lever) operators

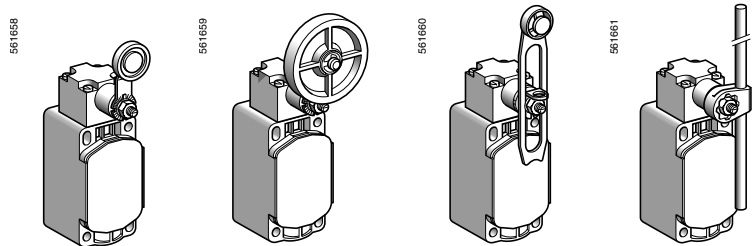

Page 126

#### Environment characteristics

<b>Conforming to standards</b>	Products	IEC 60947-5-1, EN 60947-5-1, UL 508, CSA C22-2 n° 14
	Machine assemblies	IEC 60204-1, EN 60204-1
<b>Approvals</b>		UL, CSA, CCC
<b>Protective treatment</b>	Version	Standard "TC" and "TH"
<b>Ambient air temperature</b>	For operation	- 25...+70 °C (-13...+158 °F)
	For storage	- 40...+70 °C (-40...+158 °F)
<b>Vibration resistance</b>	Conforming to IEC 60068-2-6	25 gn (10...500 Hz)
<b>Shock resistance</b>	Conforming to IEC 60068-2-27	50 gn (11 ms)
<b>Electric shock protection</b>		Class II conforming to IEC 61140 and NF C 20-030
<b>Degree of protection</b>		IP 65 conforming to IEC 60529; IK 03 conforming to EN 50102
<b>Repeat accuracy</b>		0.05 mm on the tripping points, with 1 million operating cycles for head with end plunger
<b>Cable entry</b>	Depending on model	Tapped entry for PG 13 conduit thread, or tapped ISO M20 x 1.5, 1/2" NPT with adapter
<b>Materials</b>		Body and heads: plastic



# Limit Switches

## Osiswitch® Classic, Plastic, Conforming to CENELEC EN 50041

### XCKS—Double Insulated



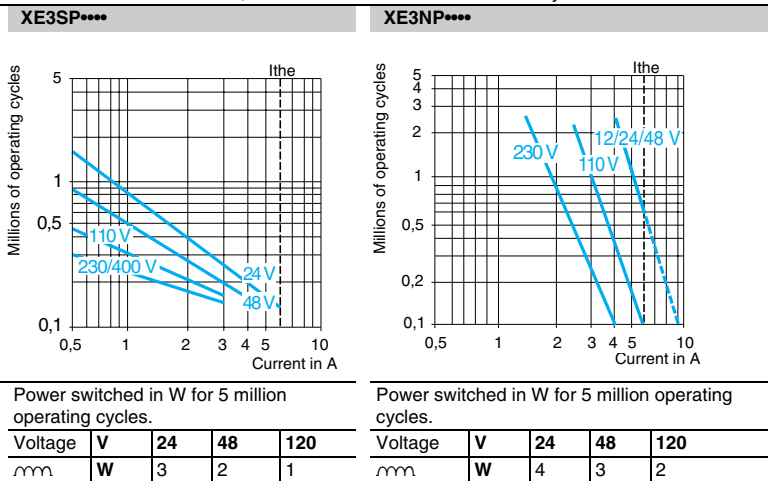
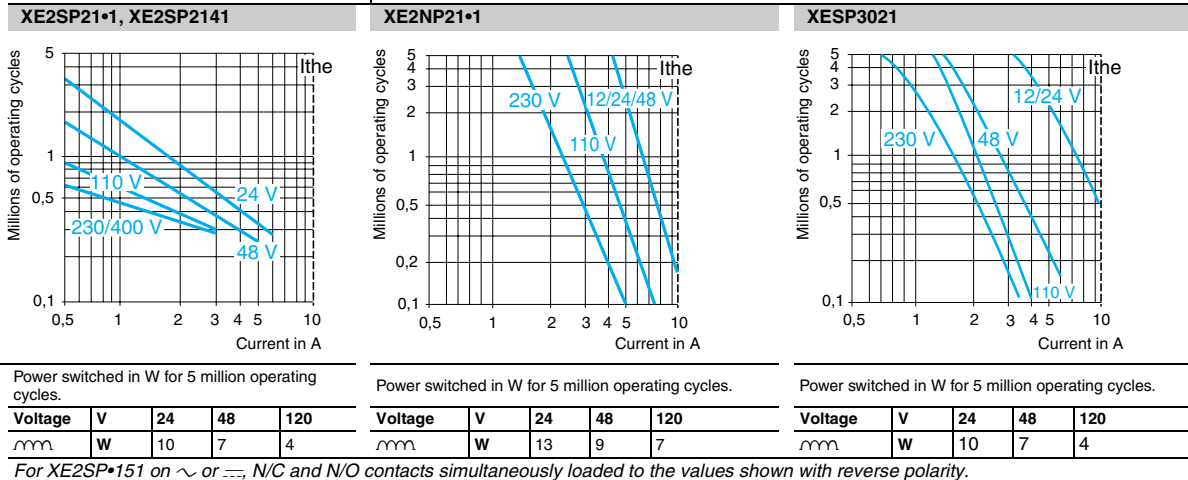







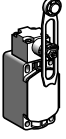

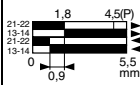
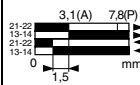
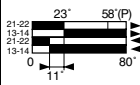
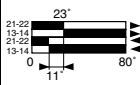
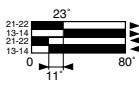
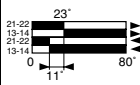
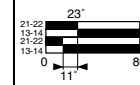

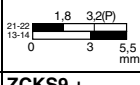
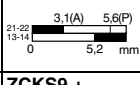
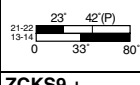
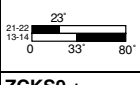
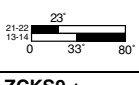
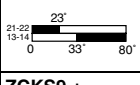
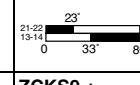

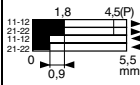
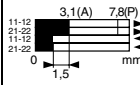
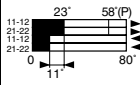
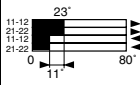
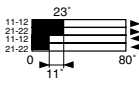
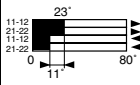
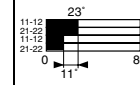

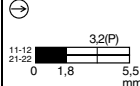
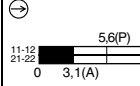
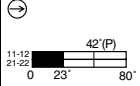
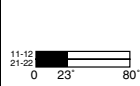
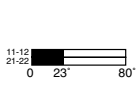
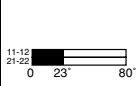
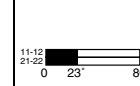

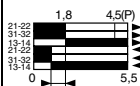
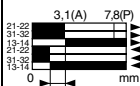
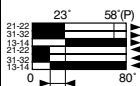

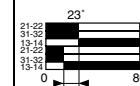

Contact block characteristics		
Rated operational characteristics	XE2•P	~ AC-15; A300 ( $U_e = 240\text{ V}$ , $I_e = 3\text{ A}$ ); $I_{the} = 10\text{ A}$ ≡ DC-13; Q300 ( $U_e = 250\text{ V}$ , $I_e = 0,27\text{ A}$ ), conforming to IEC 60947-5-1 Appendix A, EN 60947-5-1
	XE3•P	~ AC-15; B300 ( $U_e = 240\text{ V}$ , $I_e = 1,5\text{ A}$ ); $I_{the} = 6\text{ A}$ ≡ DC-13; R300 ( $U_e = 250\text{ V}$ , $I_e = 0,1\text{ A}$ ), conforming to IEC 60947-5-1 Appendix A, EN 60947-5-1
Rated insulation voltage	XE2•P	$U_i = 500\text{ V}$ degree of pollution 3 conforming to IEC 60947-1 $U_i = 300\text{ V}$ conforming to UL 508, CSA C22-2 n° 14
	XE3•P	$U_i = 400\text{ V}$ degree of pollution 3 conforming to IEC 60947-1 $U_i = 300\text{ V}$ conforming to UL 508, CSA C22-2 n° 14
Rated impulse withstand voltage	XE2•P	$U_{imp} = 6\text{ kV}$ conforming to IEC 60947-1, IEC 60664
	XE3•P	$U_{imp} = 4\text{ kV}$ conforming to IEC 60947-1, IEC 60664
Positive operation (Dpg. on model)		N/C contacts with positive opening operation conforming to IEC 60947-5-1 Appendix K, EN 60947-5-1
Resistance across terminals		$\leq 25\text{ m}\Omega$ conforming to IEC 60255-7 category 3
Short-circuit protection	XE2•P	10 A cartridge fuse type gG (gl)
	XE3•P	6 A cartridge fuse type gG (gl)
Cabling (screw and captive cable clamp terminals)	XE2SP21•1	Clamping capacity, min.: $1 \times 0,34\text{ mm}^2$ , max.: $2 \times 1,5\text{ mm}^2$
	XE2NP21•1	Clamping capacity, min.: $1 \times 0,5\text{ mm}^2$ , max.: $2 \times 2,5\text{ mm}^2$
	XESP3021	Clamping capacity, min.: $1 \times 0,75\text{ mm}^2$ , max.: $2 \times 1,5\text{ mm}^2$
	XE3NP and XE3SP	Clamping capacity, min.: $1 \times 0,34\text{ mm}^2$ , max.: $1 \times 1\text{ mm}^2$ or $2 \times 0,75\text{ mm}^2$
Minimum actuation speed		<b>XE2SP21•1, XESP3021 and XE3SP:</b> 0.01 m/minute (0.03 ft/minute) <b>XE2NP21•1 and XE3NP:</b> 6 m/minute (19.68 ft/minute)
Electrical durability		<ul style="list-style-type: none"> <li>Conforming to IEC 60947-5-1 Appendix C</li> <li>Utilization categories AC-15 and DC-13</li> <li>Maximum operating rate: 3600 operating cycles per hour</li> <li>Load factor: 0.5</li> </ul>

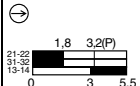
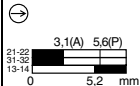
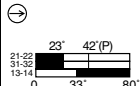
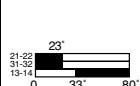
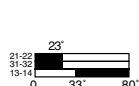
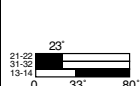
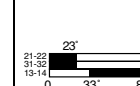

# Limit Switches

## Osiswitch® Classic, Plastic, Conforming to CENELEC EN 50041

### XCKS—Double Insulated, Complete Switches with 1/2" NPT Adapter Included

Type of head	Plunger (mounting by the body)			Rotary (mounting by the body)			
	Form B (1)	Form C (1)	Form A (1)				
Type of operator	Metal end plunger	Steel roller plunger	Thermoplastic roller lever (4)	Elastomer roller lever, Ø 50 mm (1.97 in.) (4)	Variable length thermoplastic roller lever (4)	Variable length elastomer roller lever, Ø 50 mm (1.97 in.) (4)	Round thermoplastic rod lever, Ø 6 mm (0.24 in.) (5) (6)
Catalog numbers (2) (3)	XCKS101	XCKS102	XCKS131	XCKS139	XCKS141	XCKS149	XCKS159
 2-pole N/C + N/O snap action (XE2S P2151)							
 2-pole N/C + N/O break before make, slow break (XE2N P2151)							
 2-pole N/C + N/C snap action (XE2S P2141)							
 2-pole N/C + N/C simultaneous, slow break (XE2N P2141)							
 3-pole N/C + N/C + N/O snap action (XE3S P2141)							
 3-pole N/C + N/C + N/O break before make, slow break (XE3N P2141)							
Weight, kg (lb)	0.095 (0.209)	0.105 (0.231)	0.145 (0.320)	0.150 (0.331)	0.155 (0.342)	0.155 (0.342)	0.150 (0.331)
Contact operation	 contact closed  contact open			(A) = cam displacement (P) = positive opening point	 N/C contact with positive opening operation, when properly mounted and using a conforming operator		
<b>Characteristics</b>							
Switch actuation	On end	By 30° cam					By any moving part
Type of actuation							
Maximum actuation speed	0.5 m/s (1.64 ft/s)		1.5 m/s (4.92 ft/s)		1 m/s (3.28 ft/s)		
Minimum force or torque	For tripping		0.15 N•m (1.33 lb-in)		—		
	For positive opening		0.3 N•m (2.66 lb-in)		—		
Cable entry (3)	1 entry tapped M20 x 1.5 mm for ISO cable entry, clamping capacity 7 to 13 mm (0.28 to 0.51 in.)						

- Form conforming to EN 50041, see page 21.
- Switches with gold contacts or eyelet type connections: please consult your local sales office.
- To convert PG 13 to 1/2" NPT, use adapter DE9RA1212. For ISO M20 x 1.5, add H29 to the end of the catalog number. Example: XCKS101 becomes XCKS101H29.
- Adjustable throughout 360° in 5° steps, or in 90° steps by reversing the notched washer.
- Adjustable throughout 360° in 5° steps, or in 45° steps by reversing the lever mounting.
- Value taken with actuation by moving part at 100 mm (3.94 in.) from the mounting.

# Limit Switches

## Osiswitch® Classic, Plastic, Conforming to CENELEC EN 50041

### XCKS—Double Insulated, Complete Switches with 1/2" NPT Adapter Included

**XCKS•01**  
ZCKS• + ZCKD01

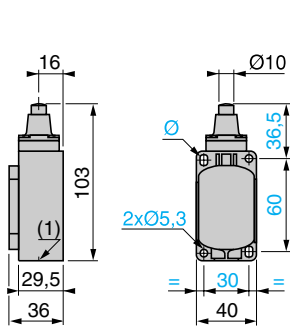

**XCKS•02**  
ZCKS• + ZCKD02

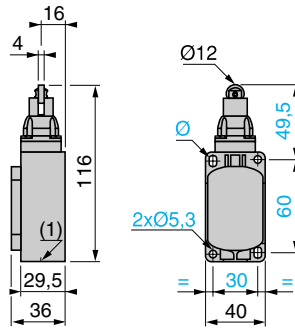

**XCKS•31**  
ZCKS• + ZCKD31

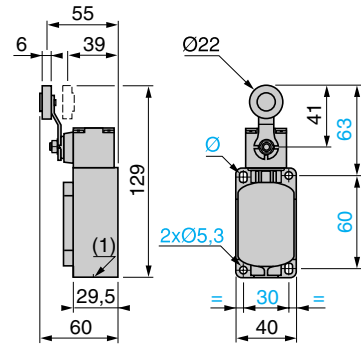

**XCKS•39**  
ZCKS• + ZCKD39

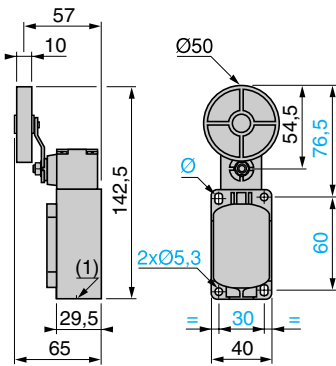

**XCKS•41**  
ZCKS• + ZCKD41

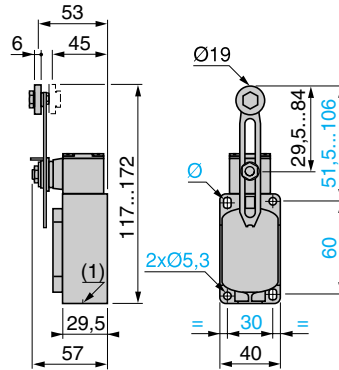

**XCKS•49**  
ZCKS• + ZCKD49

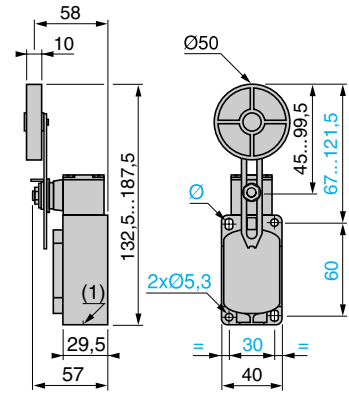

**XCKS•59**  
ZCKS• + ZCKD59

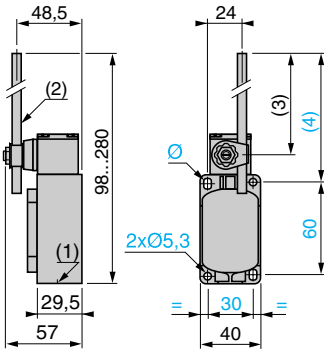

1. 1 tapped entry for PG 13 conduit thread (convertible to 1/2" NPT using adapter DE9RA1212, included); or 1 tapped entry for ISO M20 x 1.5 conduit thread (with suffix H29 added to the catalog number).
  2. Rod Ø 6 mm (0.24 in.), length 200 mm (7.87 in.)
  3. 190 max.
  4. 212 max.
- Ø: 2 elongated holes Ø 5.3 x 7.3.

Limit Switches

# Limit Switches

## Osiswitch® Classic, Plastic, Conforming to CENELEC EN 50041

### XCKS—Double Insulated, Modular

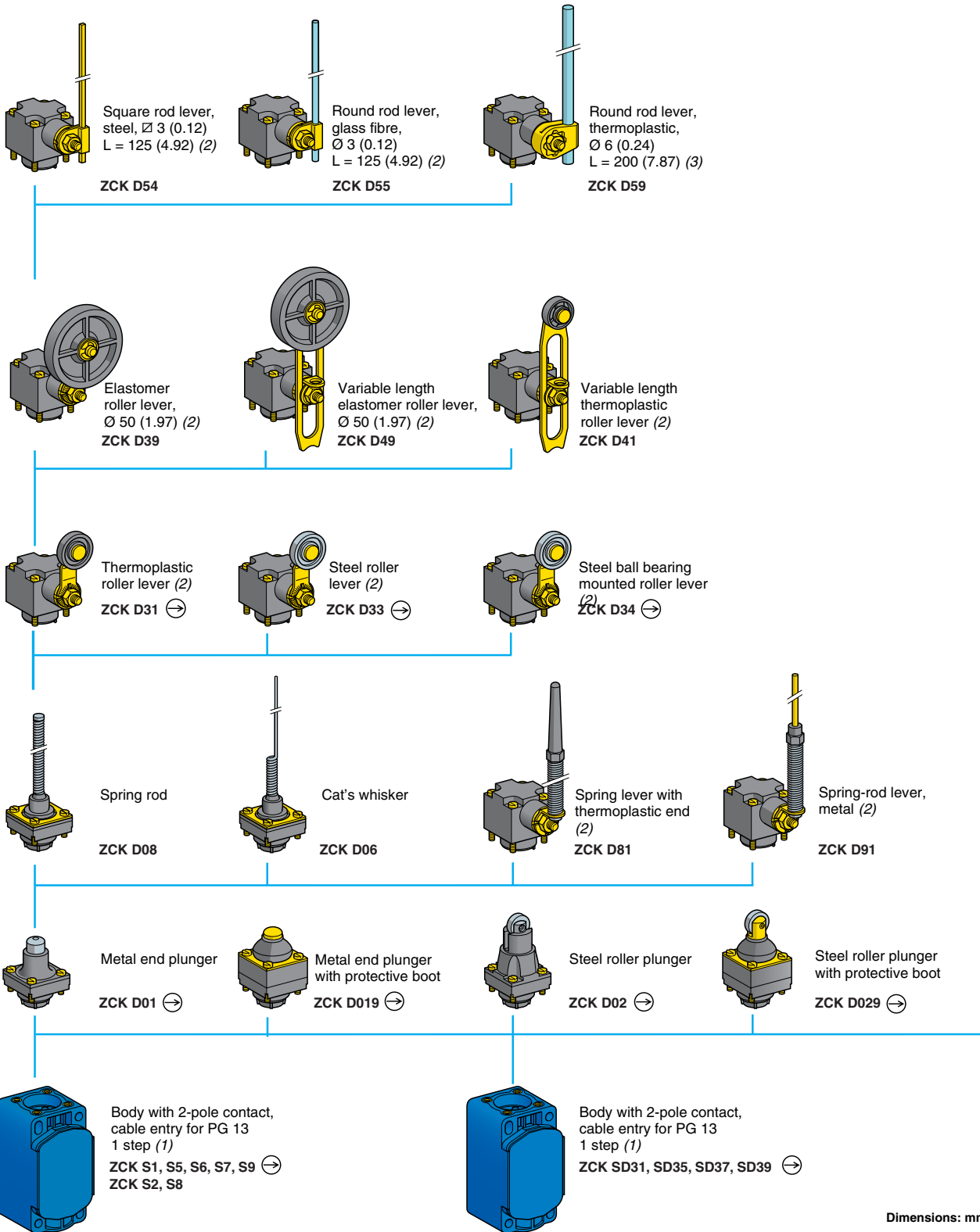

Dimensions: mm (in.)

1. For further details, see page 130. For a cable entry tapped ISO M20 x 1.5, add **H29** to the catalog number. Example: ZCKS1 becomes **ZCKS1H29**. To convert PG 13 to 1/2" NPT, use adapter DE9RA1212. See page 133 for dimensional drawing.
2. Adjustable throughout 360° in 5° steps, or in 90° steps by reversing the notched washer.
3. Adjustable throughout 360° in 5° steps, or in 45° steps by reversing the lever mounting.

# Limit Switches

## Osiswitch® Classic, Plastic, Conforming to CENELEC EN 50041

### XCKS—Double Insulated, Modular

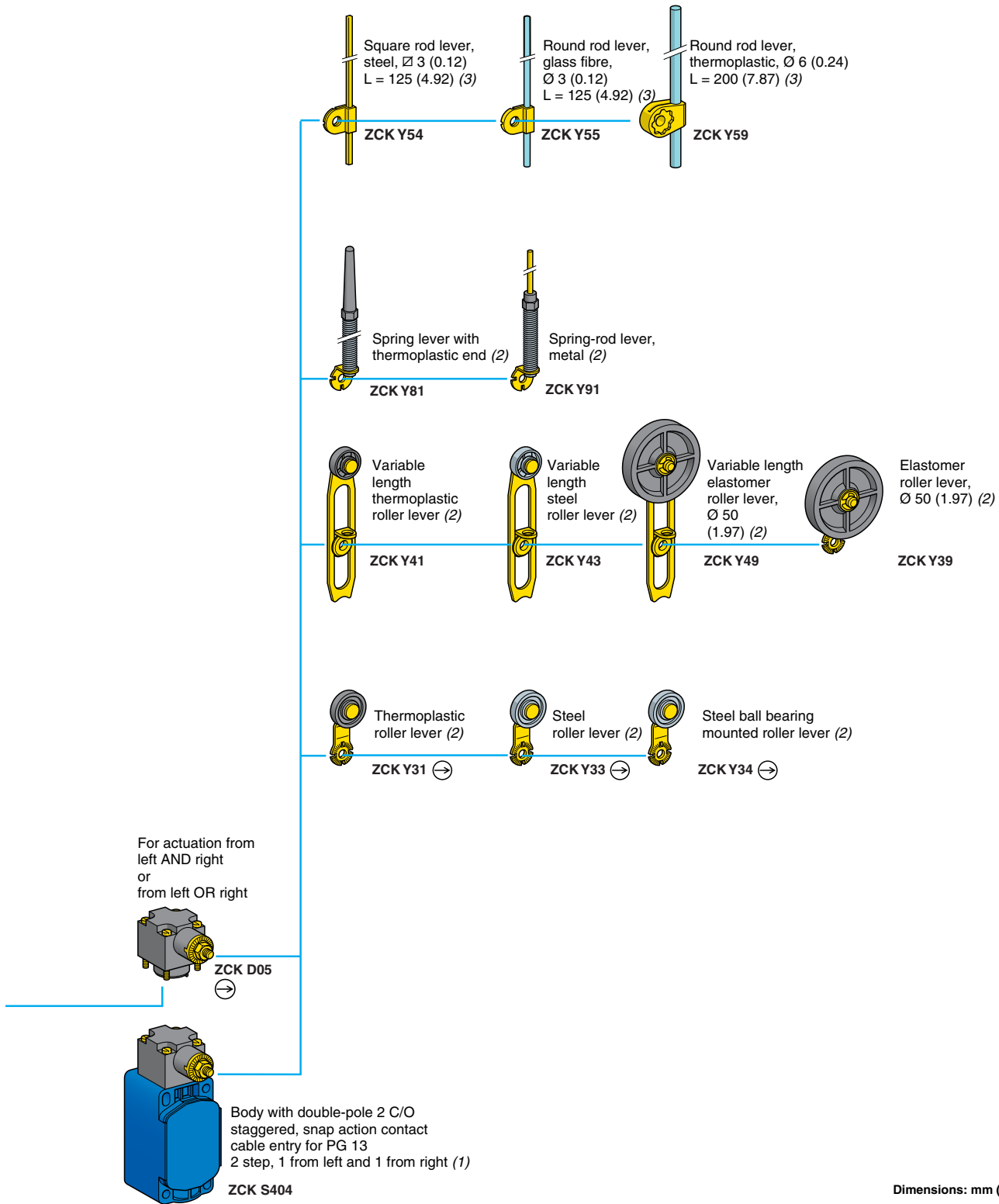

1. For further details, see page 130. For a cable entry tapped ISO M20 x 1.5, add **H29** to the catalog number. Example: ZCKS1 becomes **ZCKS1H29**. To convert PG 13 to 1/2" NPT, use adapter DE9RA1212.
- ⊖: N/C contact with positive opening operation or head assuring positive opening operation, when properly mounted and using a conforming operator.
2. Adjustable throughout 360° in 5° steps, or in 90° steps by reversing the notched washer.
3. Adjustable throughout 360° in 5° steps, or in 45° steps by reversing the lever mounting.

**Limit Switches**  
**Osiswitch® Classic, Plastic, Conforming to CENELEC EN 50041**  
**XCKS—Double Insulated, Modular**

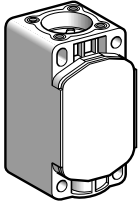

Limit Switches

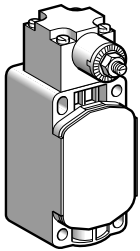

Bodies with 2-pole contact						
Type	With contact block	Function diagram	Positive operation (1)	Cable entry	Catalog number	Weight kg (lb)
1 step	N/C + N/O snap action (XE2S P2151)		⊕	1/2" NPT	ZCKS1	0.080 (0.176)
				ISO M20 x 1.5	ZCKS1H29	0.080 (0.176)
	2 C/O simultaneous, snap action (XES P3021)		—	1/2" NPT	ZCKS2	0.080 (0.176)
				ISO M20 x 1.5	ZCKS2H29	0.080 (0.176)
	N/C + N/O break before make, slow break (XE2N P2151)		⊕	1/2" NPT	ZCKS5	0.080 (0.176)
				ISO M20 x 1.5	ZCKS5H29	0.080 (0.176)
	N/O + N/C make before make, slow break (XE2N P2161)		⊕	1/2" NPT	ZCKS6	0.080 (0.176)
			ISO M20 x 1.5	ZCKS6H29	0.080 (0.176)	
N/C + N/C simultaneous, slow break (XE2N P2141)		⊕	1/2" NPT	ZCKS7	0.080 (0.176)	
			ISO M20 x 1.5	ZCKS7H29	0.080 (0.176)	
N/O + N/O simultaneous, slow break (XE2N P2131)		—	1/2" NPT	ZCKS8	0.080 (0.176)	
			ISO M20 x 1.5	ZCKS8H29	0.080 (0.176)	
N/C + N/C snap action (XE2S P2141)		⊕	1/2" NPT	ZCKS9	0.080 (0.176)	
			ISO M20 x 1.5	ZCKS9H29	0.080 (0.176)	
Bodies with double-pole contact and spring return rotary head						
Without operating lever						
Type	With contact block	Function diagram	Positive operation (1)	Cable entry	Catalog number	Weight kg (lb)
2 step 1 from left and 1 from right	2 C/O staggered, snap action		—	1/2" NPT	ZCKS404	0.150 (0.331)
				ISO M20 x 1.5	ZCKS404H29	0.150 (0.331)
Bodies with 3-pole contact and 1 cable entry						
Type	With contact block	Function diagram	Positive operation (1)	Cable entry	Catalog number	Weight kg (lb)
1 step	N/C + N/O + N/O snap action (XE3S P2151)		⊕	1/2" NPT	ZCKSD31	0.080 (0.176)
				ISO M20 x 1.5	ZCKSD31H29	0.080 (0.176)
	N/C + N/C + N/O snap action (XE3S P2141)		⊕	1/2" NPT	ZCKSD39	0.080 (0.176)
				ISO M20 x 1.5	ZCKSD39H29	0.080 (0.176)
	N/C + N/C + N/O break before make, slow break (XE3N P2141)		⊕	1/2" NPT	ZCKSD37	0.080 (0.176)
				ISO M20 x 1.5	ZCKSD37H29	0.080 (0.176)
N/C + N/O + N/O break before make, slow break (XE3N P2151)		⊕	1/2" NPT	ZCKSD35	0.080 (0.176)	
			ISO M20 x 1.5	ZCKSD35H29	0.080 (0.176)	

1. ⊕: N/C contact with positive opening operation or head assuring positive opening operation, when properly mounted and using a conforming operator.

# Limit Switches

Osiswitch® Classic, Plastic, Conforming to CENELEC EN 50041

XCKS—Double Insulated, Modular

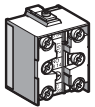
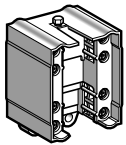
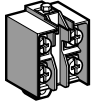

Contact blocks					
Type of contact	Function diagram	For body	Positive operation (1)	Catalog number	Weight kg (lb)
<b>2-pole contact</b>					
N/C + N/O snap action		ZCKS1	⊕	XE2S P2151	0.020 (0.044)
N/C + N/O break before make, slow break		ZCKS5	⊕	XE2N P2151	0.020 (0.044)
2 C/O simultaneous, snap action		ZCKS2	—	XES P3021	0.045 (0.099)
N/O + N/C make before break, slow break		ZCKS6	⊕	XE2N P2161	0.020 (0.044)
N/C + N/C simultaneous, slow break		ZCKS7	⊕	XE2N P2141	0.020 (0.044)
N/O + N/O simultaneous, slow break		ZCKS8	—	XE2N P2131	0.020 (0.044)
N/C + N/C snap action		ZCKS9	⊕	XE2S P2141	0.020 (0.044)
<b>3-pole contact</b>					
N/C + N/O + N/O snap action		ZCKSD31	⊕	XE3S P2151	0.035 (0.077)
N/C + N/C + N/O snap action		ZCKSD39	⊕	XE3S P2141	0.035 (0.077)
N/C + N/C + N/O break before make, slow break		ZCKSD37	⊕	XE3N P2141	0.035 (0.077)
N/C + N/O + N/O break before make, slow break		ZCKSD35	⊕	XE3N P2151	0.035 (0.077)
1. ⊕: N/C contact with positive opening operation or sub-assembly assuring positive opening operation, when properly mounted and using a conforming operator.					
<b>Other versions</b>	Gold flashed contacts. Please consult your local sales office.				

1/2" NPT Adapter		
Description	Catalog number	Weight kg (lb)
PG 13 to 1/2" NPT adapter	DE9RA1212	

Limit Switches

# Limit Switches

## Osiswitch® Classic, Plastic, Conforming to CENELEC EN 50041

### XCKS—Double Insulated, Modular

Limit Switches

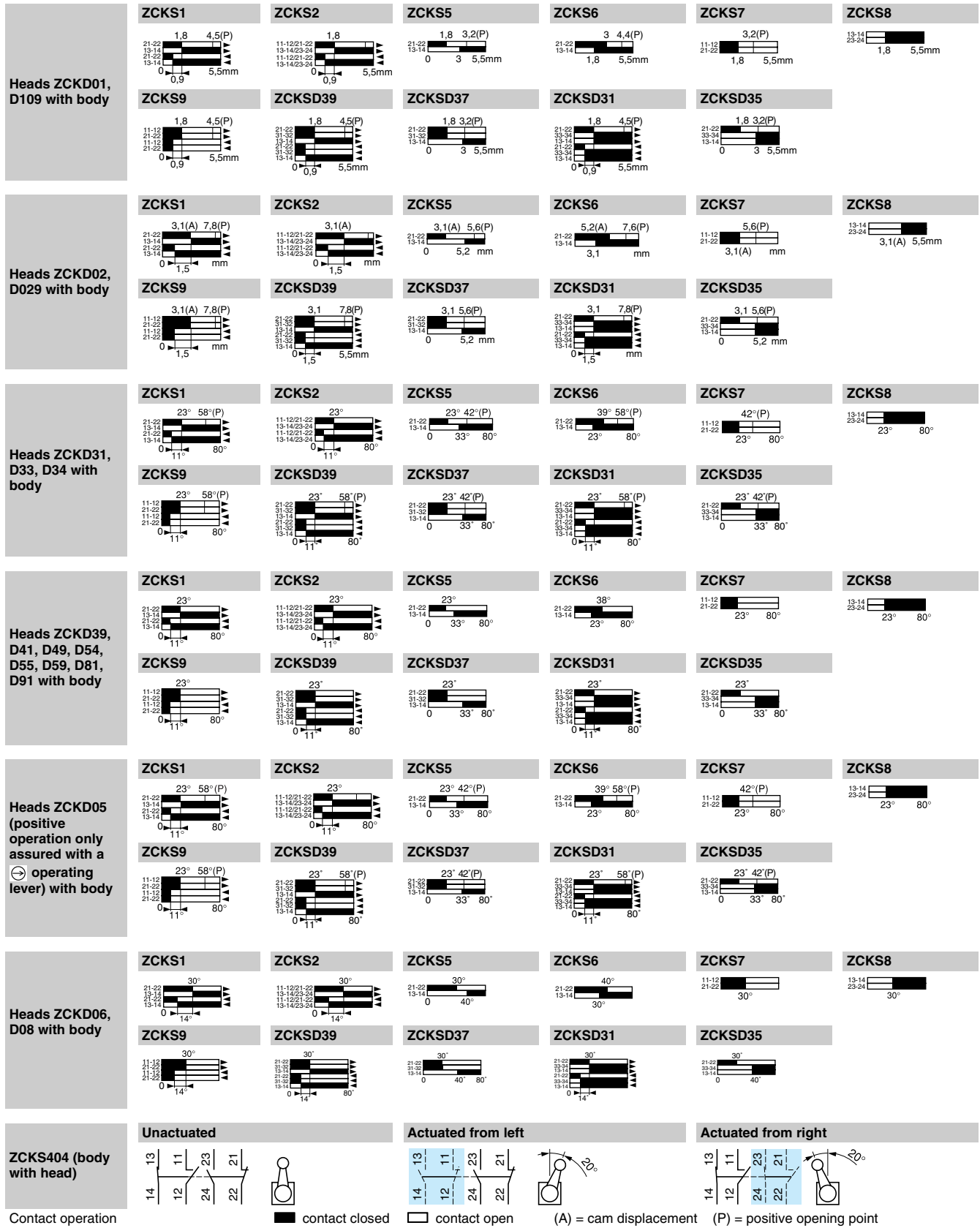



# Limit Switches

Osiswitch® Classic, Plastic, Conforming to CENELEC EN 50041

XCKS—Double Insulated, Modular

## Plunger heads

ZCKD01

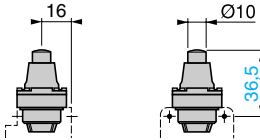

ZCKD019

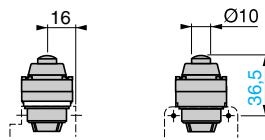

ZCKD02

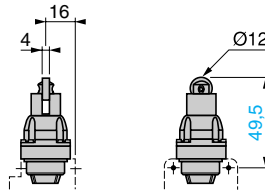

ZCKD029

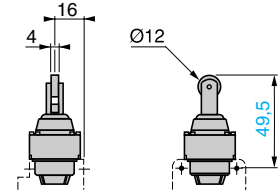

## Rotary heads

ZCKD31, D33, D34

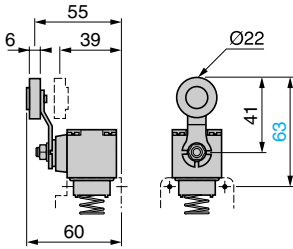

ZCKD39

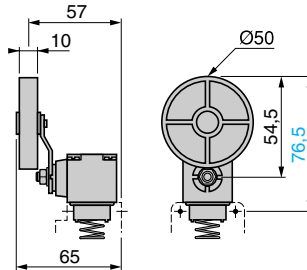

ZCKD41

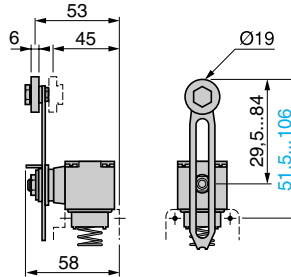

ZCKD49

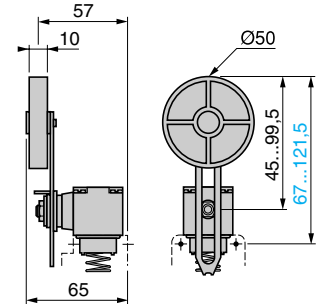

ZCKD54, D55, D59

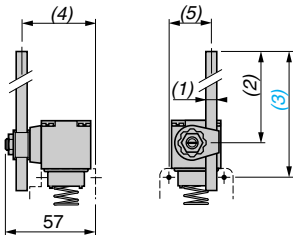

ZCKD81

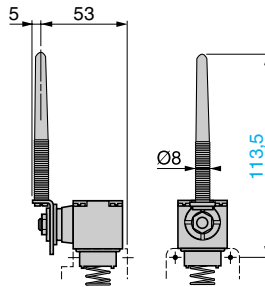

ZCKD91

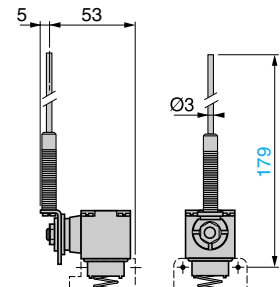

ZCK	(1) rod	(2)	(3)	(4)	(5)
D54	Ø 3, L = 125	115 max.	137 max.	49	24
D55	Ø 3, L = 125	115 max.	137 max.	49	24
D59	Ø 6, L = 200	190 max.	212 max.	46.5	26.2

NOTE: operating lever spindle threaded M6.

## Multi-directional heads

ZCKD06

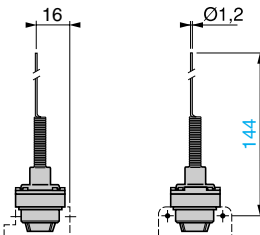

ZCKD08

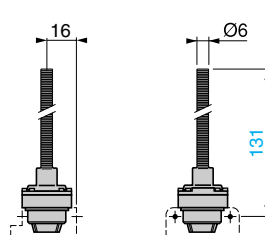

## Bodies with contacts

ZCKS1, S2, S5, S6, S7, S8, S9  
ZCKS1H29, S2H29, S5H29,  
S6H29, S7H29, S8H29, S9H29  
ZCKSD3\*, SD3\*H29

ZCKS404, S404H29

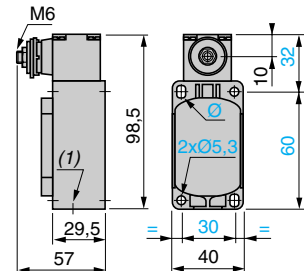
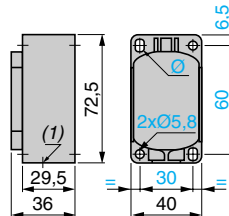

## DE9RA1212 (PG 13 to 1/2" NPT adapter)

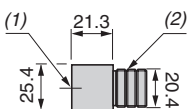

1. Tapped entry for 1/2" NPT conduit
2. PG 13 threaded sleeve

1. 1 tapped entry for PG 13 conduit thread (convertible to 1/2" NPT using adapter DE9RA1212); or 1 tapped entry for ISO M20 x 1.5 conduit thread (with suffix H29 added to the catalog number).
- Ø: 2 elongated holes Ø 5.3 x 7.3.

# Limit Switches

## Osiswitch® Classic, For Hoisting, Mechanical Handling, and Conveyer Belt Shift Monitoring XCR and XCRT

### ■ XCR

□ With head for rotary movement operators, spring return to off position  
1 contact actuation position per direction

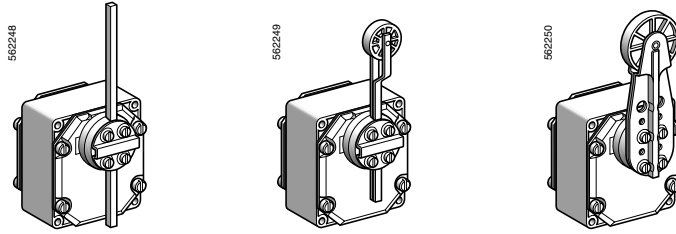

Page 136

□ With head for rotary movement operators, stay put  
1 contact actuation position per direction

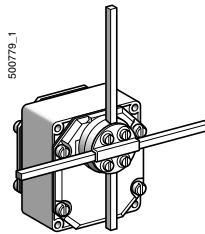

Page 136

### ■ XCRT

□ With head for rotary movement operators, spring return to off position  
2 contact actuation positions per direction  
1 actuated at 10°, other contact actuated at 18°

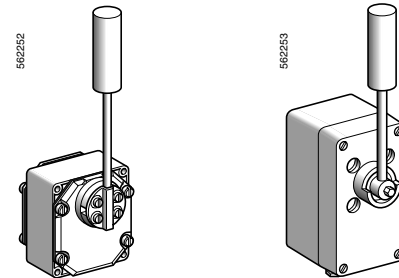

Page 138

# Limit Switches

## Osiswitch® Classic, For Hoisting, Mechanical Handling, and Conveyor Belt Shift Monitoring XCR and XCRT

Environment characteristics		
Conforming to standards	Products	IEC/EN 60947-5-1, VDE 0660-200 (CSA C22-2 n° 14 for XCR), CCC (for XCR)
	Machine assemblies	IEC/EN 60204-1, NF C 79-130
Product certifications	Standard version	X CRA, B, E, F: CSA A300
	Special version	X CRA, B, E, F: CSA A300, 1/2" NPT
Protective treatment	Standard version	"TC"
Ambient air temperature		Operation: -25...+70 °C (-13...+158 °F); Storage: -40...+70 °C (-40...+158 °F)
Vibration resistance		9 gn (10...500 Hz)
Shock resistance		X CRA, B, E, F: 68 gn; XCRT: 30 gn (18 ms)
Electric shock protection		Class I conforming to IEC 60536 and NF C 20-030
Degree of protection		X CRA, B, E, F: IP 54 conforming to IEC 60529; IP 545 conforming to NF C 20-010 XCRT: IP 65 conforming to IEC 60529; IP 655 conforming to NF C 20-010
Enclosure		Metal, except XCRT315: polyester
Cable entry		Tapped entry for PG 13 (PG 13.5) conduit thread

Contact block characteristics		
Rated operational characteristics		~ AC-15; A300 (Ue = 240 V, Ie = 3 A) == DC-13; Q300 (Ue = 250 V, Ie = 0.27 A), conforming to IEC 60947-5-1 Appendix A, EN 60947-5-1
Rated insulation voltage		Ui = 500 V degree of pollution 3 conforming to IEC 60947-1 and VDE 0110, group C conforming to NF C 20-040 Ui = 300 V conforming to UL 508, CSA C22-2 n° 14
Rated impulse withstand voltage		U imp = 6 kV conforming to IEC 60947-1, IEC 60664
Positive operation (Depending on model)		N/C contacts with positive opening operation to IEC 60947-5-1 Section 3, EN 60947-5-1
Resistance across terminals		≤ 25 mΩ conforming to NF C 93-050 method A or IEC 60255-7 category 3
Short-circuit protection		10 A cartridge fuse type gG (gl)
Cabling	Screw clamp terminals	XE2SP2151: Clamping capacity, min: 1 x 0.34 mm <sup>2</sup> , max: 2 x 1.5 mm <sup>2</sup> XE2NP2151: Clamping capacity, min: 1 x 0.5 mm <sup>2</sup> , max: 2 x 2.5 mm <sup>2</sup> XCRT contacts: Clamping capacity, min: 1 x 0.5 mm <sup>2</sup> , max: 2 x 2.5 mm <sup>2</sup>
Minimum actuation speed		XE2SP2151 and XCRT contacts: 0.01 m/minute (0.03 ft/minute), XE2NP2151: 6 m/minute (19.68 ft/minute)
Electrical durability		Conforming to IEC 60947-5-1 Appendix C Utilization categories AC-15 and DC-13 Maximum operating rate: 3600 operating cycles per hour Load factor: 0.5

**XE2SP2151**

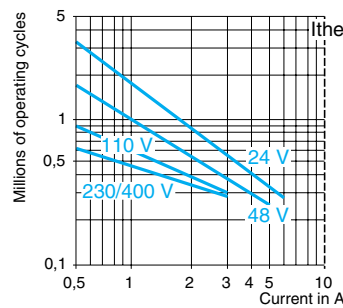

**XE2NP2151**

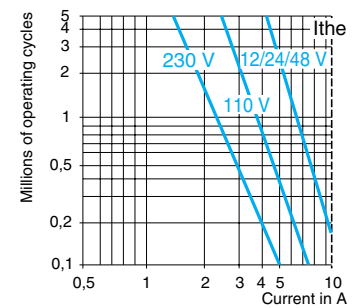

a.c. supply  
~ 50/60 Hz  
~ inductive circuit

**XCRT contacts**

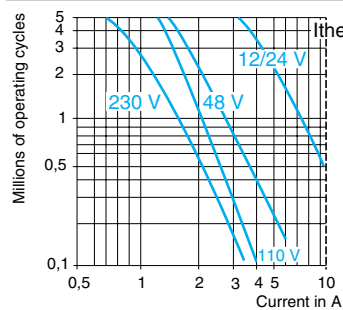

d.c. supply ==

Power switched in W for 5 million operating cycles W ~

Voltage	24 V	48 V	120 V
XE2SP2151	10	7	4
XE2NP2151	13	9	7
XCRT contacts	10	7	4

For XE2SP2151 on ~ or == N/C and N/O contacts simultaneously loaded to the values shown with reverse polarity.

# Limit Switches

## Osiswitch® Classic, For Hoisting and Material Handling

### XCR—Complete Switches with One Cable Entry

Type of head	Rotary with spring return to off position	Stay put
Maximum displacement	55° in each direction	90° in each direction

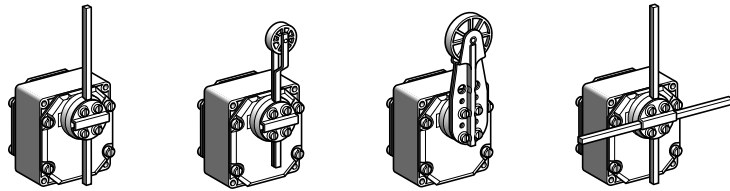

Type of operator	Metal rod, $\varnothing$ 6 mm (0.24 in.)	Thermoplastic roller lever	Large thermoplastic roller lever	Metal rods, $\varnothing$ 6 mm (0.24 in.) crossed or "T" (1)
------------------	--	----------------------------	----------------------------------	--

1. Crossed rods for XCRE•8, "T" rods for XCRF•7.

#### Catalog numbers of complete switches (↻) N/C contact with positive opening operation

<p><b>Two 2-pole 1 N/C + 1 N/O snap action XE2SP2151</b></p> <p>1<sup>st</sup> contact      2<sup>nd</sup> contact</p>	Both contacts operate in each direction	<p><b>X CRA11</b> (↻)</p>	<p><b>X CRA12</b> (↻)</p>	<p><b>X CRA15</b> (↻)</p>	<p><b>X CRE18</b> (↻)</p>
	1 contact operates in each direction	<p><b>X CRB11</b> (↻)</p>	<p><b>X CRB12</b> (↻)</p>	<p><b>X CRB15</b> (↻)</p>	<p><b>X CRF17</b> (↻)</p>
<p><b>Two 2-pole 1 N/C + 1 N/O break before make, slow break XE2NP2151</b></p> <p>1<sup>st</sup> contact      2<sup>nd</sup> contact</p>	Both contacts operate in each direction	<p><b>X CRA51</b> (↻)</p>	<p><b>X CRA52</b> (↻)</p>	<p><b>X CRA55</b> (↻)</p>	<p><b>X CRE58</b> (↻)</p>
	1 contact operates in each direction	<p><b>X CRB51</b> (↻)</p>	<p><b>X CRB52</b> (↻)</p>	<p><b>X CRB55</b> (↻)</p>	<p><b>X CRF57</b> (↻)</p>
<b>Weight, kg (lb)</b>		1.110	1.145	1.155	1.135

**Contact operation**

■ contact closed (P) = positive opening point  
□ contact open

1. 1<sup>st</sup> contact  
2. 2<sup>nd</sup> contact

#### Complementary characteristics not shown under general characteristics (page 125)

<b>Maximum actuation speed</b>	1.5 m/s (4.92 ft/s)	
<b>Minimum torque</b>	For tripping	0.45 N•m (3.98 lb-in)
	For positive opening	0.75 N•m (6.64 lb-in)
<b>Cable entry</b>	1 entry tapped for PG 13 conduit thread conforming to NF C 68-300 (DIN PG 13.5). Clamping capacity 9 to 12 mm (0.35 to 0.47 in.). 1/2" NPT with adapter DE9RA1212.	

# Limit Switches

## Osiswitch® Classic, For Hoisting and Material Handling

### XCR—Complete Switches with One Cable Entry

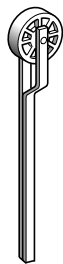

XCRZ02



XCRZ05

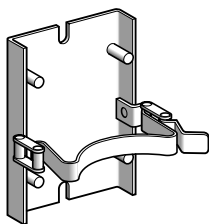

XCRZ09

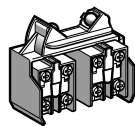

XCRZ1•

#### Separate components

Description	For switches	Type	Catalog number	Weight kg (lb)
Rod, $\varnothing$ 6 mm (0.24 in.)	XCRA XCRB	L = 200 mm (7.87 in.)	<b>XCRZ03</b>	0.020 (0.044)
		L = 300 mm (11.81 in.)	<b>XCRZ04</b>	0.030 (0.066)
Roller lever thermoplastic roller	XCRA XCRB	—	<b>XCRZ02</b>	0.050 (0.110)
Large roller lever thermoplastic roller	XCRA XCRB	—	<b>XCRZ05</b>	0.090 (0.198)
Quick mounting/ release bracket	XCRA, XCRB XCRE, XCRF	—	<b>XCRZ09</b>	0.520 (1.146)
Contact block (2 contacts) with mounting plate	XCRA, XCRB XCRE, XCRF	2-pole 1 N/C + 1 N/O snap action	<b>XCRZ12</b>	0.135 (0.298)
		2-pole 1 N/C + 1 N/O break before make, slow break	<b>XCRZ15</b>	0.135 (0.298)
Description	Application	Sold in lots of	Unit catalog number	Weight kg (lb)
Adapter	PG 13.5 to ISO M20 x 1.5	5	<b>DE9RA13520</b>	0.050 (0.110)
Adapter	PG 13.5 to 1/2" NPT	5	<b>DE9RA1212</b>	0.050 (0.110)

# Limit Switches

## Osiswitch® Classic, For Conveyer Belt Shift Monitoring

XCRT—Complete Switches with One Cable Entry and 1/2" NPT Adapter Included

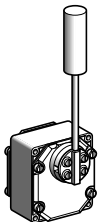
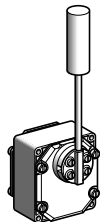
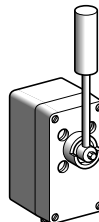
Type of switch	Standard	For corrosive atmospheres	
			

Features	Standard	For corrosive atmospheres (Zinc alloy)	For corrosive atmospheres (Glass reinforced polyester)
	Zinc alloy enclosure Colour: industrial blue Zinc plated steel lever, spring return to off position Cam angles: 10° and 18° Maximum displacement: 90°	Zinc alloy enclosure Colour: blue Stainless steel lever, spring return to off position Cam angles: 10° and 18° Maximum displacement: 90°	Glass reinforced polyester enclosure Colour: grey Stainless steel lever, spring return to off position Cam angles: 10° and 18° Maximum displacement: 70°

### Catalog numbers of complete switches

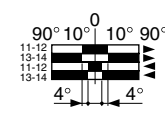
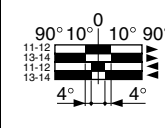
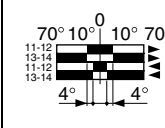
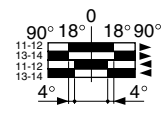
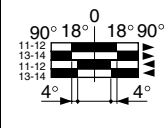
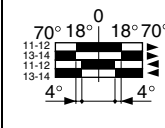
2 single-pole C/O snap action	XCRT115	XCRT215	XCRT315
1 <sup>st</sup> contact			
2 <sup>nd</sup> contact			
Weight, kg (lb)	1.170 (2.579)	1.170 (2.579)	1.520 (3.351)

Contact operation	 ■ contact closed □ contact open
-------------------	---

### Complementary characteristics not shown under general characteristics (page 125)

Minimum tripping torque	1.0 N•m (8.85 lb-in)
Cable entry	1 entry tapped for PG 13 conduit thread conforming to NF C 68-300 (DIN PG 13.5) Clamping capacity 9 to 12 mm (0.35 to 0.47 in.) 1/2" NPT with adapter DE9RA1212 included

### Switch operation

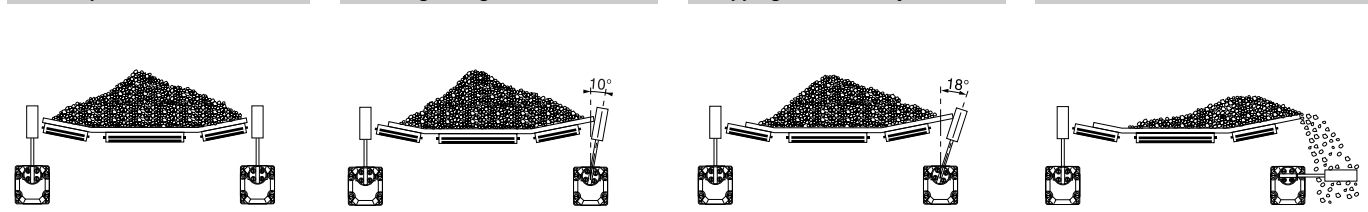

Dimensions:  
page 141

Limit Switches

# Limit Switches

## Osiswitch® Classic, For Conveyer Belt Shift Monitoring

XCRT—Complete Switches with One Cable Entry and 1/2" NPT Adapter Included

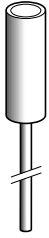

XCRZ90

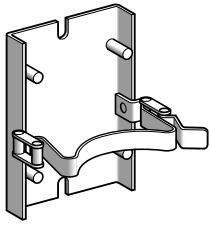

XCRZ09

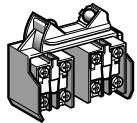

XCRZ42

### Separate components

Description	Type	For switches	Catalog number	Weight kg (lb)
Roller with lever	Zinc plated steel	XCRT115 XCRT215	XCRZ901	0.230 (0.507)
	Stainless steel	XCRT115 XCRT215	XCRZ902	0.230 (0.507)
		XCRT315	XCRZ903	0.230 (0.507)
Quick mounting/release bracket	—	XCRT115 XCRT215	XCRZ09	0.520 (1.146)
Contact block (2 contacts) with mounting plate	Single-pole C/O snap action	XCRT•15	XCRZ42	0.135 (0.298)

  

Description	Application	Sold in lots of	Unit catalog number	Weight kg (lb)
Adapter	PG 13.5 to ISO M20 x 1.5	5	DE9RA13520	0.050 (0.110)
Adapter	PG 13.5 to 1/2" NPT	5	DE9RA1212	0.050 (0.110)

# Limit Switches

## Osiswitch® Classic, For Hoisting, Mechanical Handling, and Conveyor Belt Shift Monitoring XCR and XCRT

**XCRA11, B11, A51, B51**

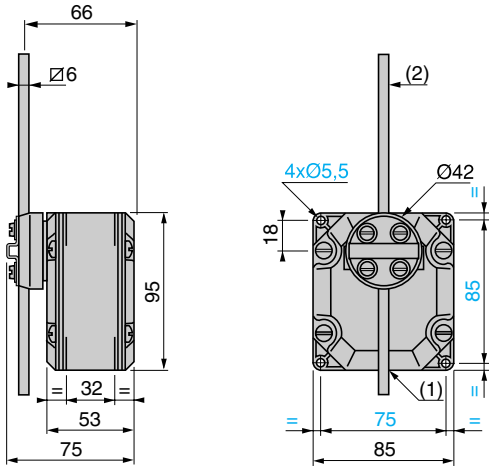

**XCRA12, B12, A52, B52**

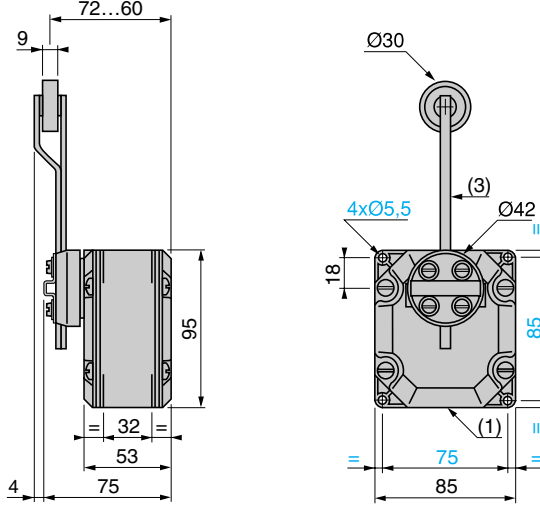

**XCRA15, B15, A55, B55**

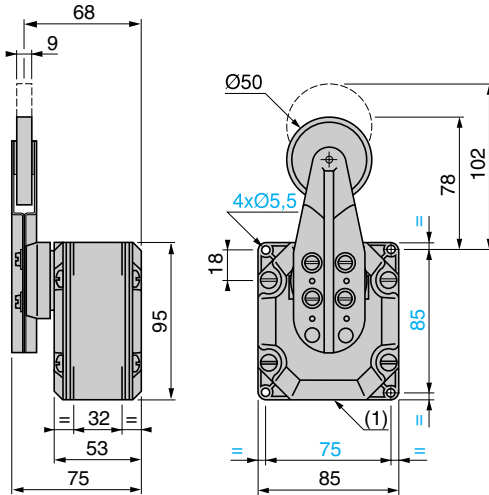

**XCRE18, E58, F17, F57**

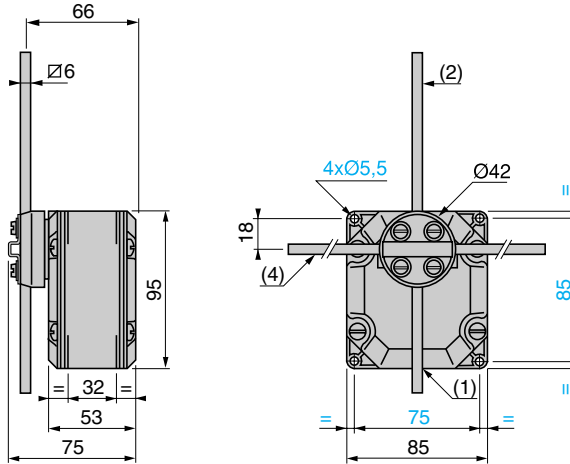

1. 1 tapped entry for PG 13 conduit thread.
2. Rod length: 200 mm (7.87 in.).
3. Rod + roller length: 160 mm (6.30 in.).
4. Rod length: 300 mm (11.81 in.) for XCRF17 and F57, 200 mm (7.87 in.) for XCR E18 and E58.

**Supplementary mounting using 2 adjustable lugs (included with switch)**

**Horizontally positioned**

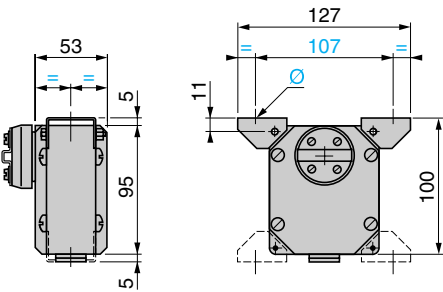

**Vertically positioned**

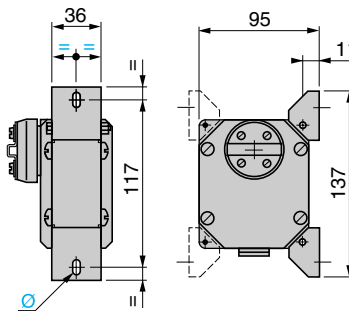

**Quick mounting/release bracket XCRZ09**

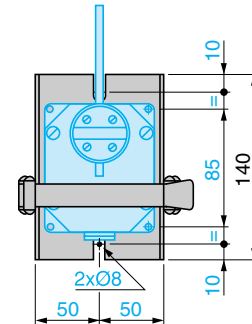

Ø: 1 elongated hole Ø 6 x 8.

Characteristics:  
pages 135 and 136

Catalog numbers:  
page 136

Operation:  
page 136



# Limit Switches

## Osiswitch® Classic, For Hoisting, Mechanical Handling, and Conveyor Belt Shift Monitoring XCR and XCRT

### XCRT115, T215

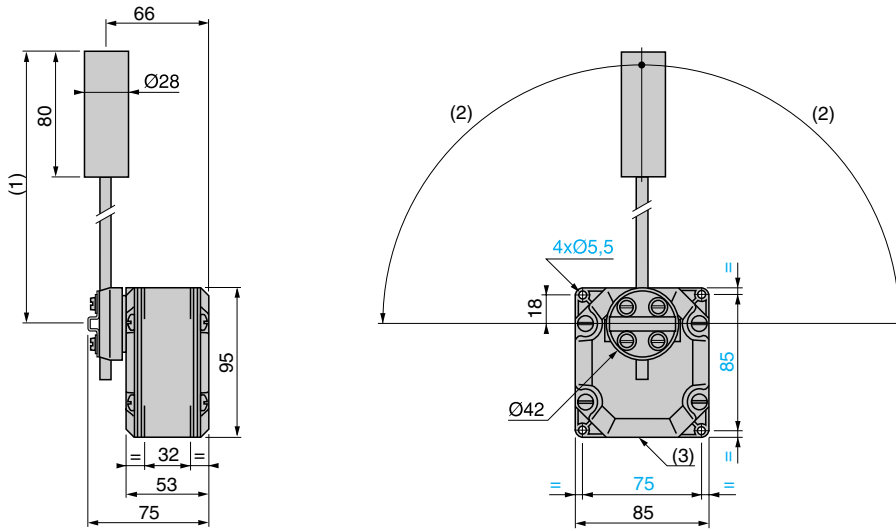

### XCRT315

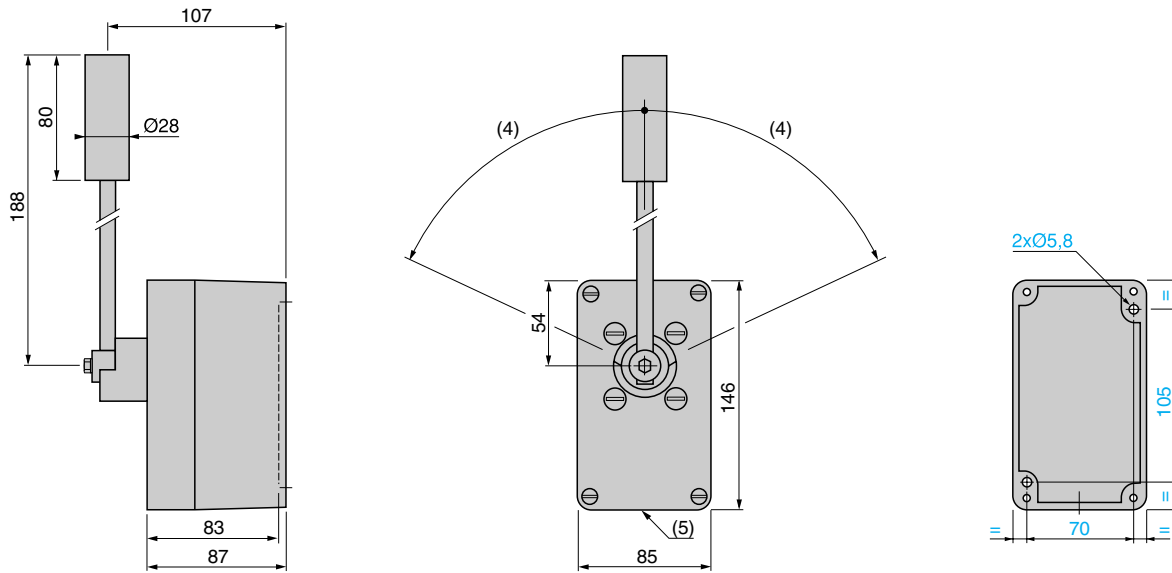

1. 200 max., 83 min.
2. 90° max.

3. 1 tapped entry for PG 13 conduit thread.
4. 70° max.

5. 1 plain entry for PG 13 conduit thread.

### Supplementary mounting using 2 adjustable lugs (included with XCRT115 and T215)

#### Horizontally positioned

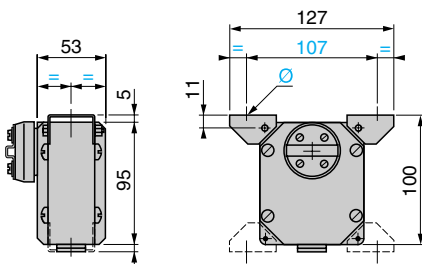

Ø: 1 elongated hole Ø 6 x 8.

#### Vertically positioned

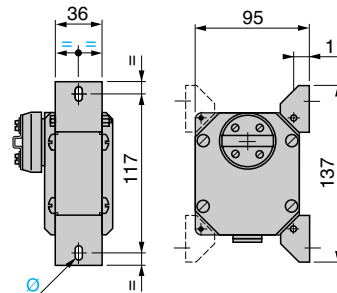

### Quick mounting/release bracket XCRZ09

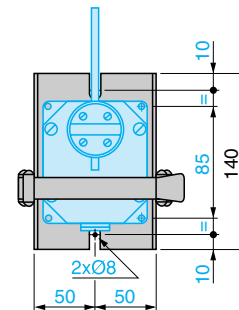

Characteristics:  
pages 135 and 138

Catalog numbers:  
page 138

Operation:  
page 139

# Limit Switches

## Osiswitch® Classic, For Material Handling

### XC1AC

■ XC1AC  
with slow break contacts

□ With head for linear movement (plunger)

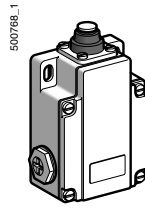

Page 144

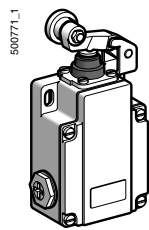
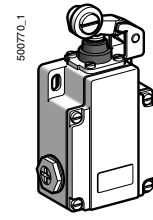
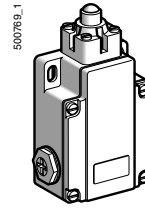

Page 144

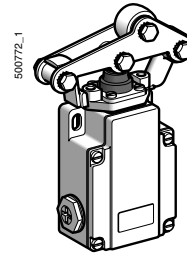

# Limit Switches

## Osiswitch® Classic, For Material Handling



### XC1AC

Environment characteristics																																				
Conformity to standards	IEC/EN 60947-5-1, IEC 60337-1, VDE 0660-200, CSA C22-2 n° 14																																			
Product certifications	Special version CSA 600 V (ac) HD																																			
Protective treatment	Version Standard "TC", special "TH"																																			
Ambient air temperature	For operation - 25...+70 °C (-13...+158 °F)																																			
	For storage - 40...+70 °C (-40...+158 °F)																																			
Operating position	All positions																																			
Vibration resistance	9 gn (10...500 Hz) conforming to IEC 60068-2-6																																			
Shock resistance	95 gn (11 ms) conforming to IEC 60068-2-27																																			
Electric shock protection	Class I conforming to IEC 60536 and NF C 20-030																																			
Degree of protection	<b>IP 65 conforming to IEC 60529 and NF C 20-010</b>																																			
Mechanical durability	10 million operating cycles																																			
Cable entry	3 tapped entries for PG 13 conduit thread																																			
Contact block characteristics																																				
Conventional thermal current	10 A																																			
Rated insulation voltage	Slow break contact blocks ~ 500 V and = 600 V conforming to IEC 60947-5-1, NF C 20-040 ~ and = 600 V conforming to CSA C22-2 n° 14																																			
Resistance across terminals	≤ 8 mΩ																																			
Minimum tripping force	<b>XC1AC1-1</b> : 33 N (7.42 lb); <b>XC1AC1-6</b> : 23 N (5.17 lb); <b>XC1AC1-7</b> : 29 N (6.52 lb)																																			
Terminal referencing	Conforming to CENELEC EN 50013																																			
Short-circuit protection	10 A cartridge fuse type gG (gl)																																			
Electrical durability	<ul style="list-style-type: none"> <li>Conforming to IEC 60947-5-1 Appendix C</li> <li>Utilization categories AC-15 and DC-13</li> <li>Maximum operating rate: 3600 operating cycles/hour</li> <li>Load factor: 0.5</li> </ul>																																			
	<table border="1"> <thead> <tr> <th colspan="4">Slow break contact blocks</th> </tr> <tr> <th colspan="4">Power switched in VA</th> </tr> <tr> <th>Voltage V</th> <th>48</th> <th>110</th> <th>230</th> </tr> </thead> <tbody> <tr> <td>For 1 million operating cycles</td> <td>450</td> <td>900</td> <td>1900</td> </tr> <tr> <td>For 3 million operating cycles</td> <td>170</td> <td>350</td> <td>430</td> </tr> <tr> <th colspan="4">Power switched in W</th> </tr> <tr> <th>Voltage V</th> <th>48</th> <th>110</th> <th>230</th> </tr> <tr> <td>For 1 million operating cycles</td> <td>100</td> <td>100</td> <td>95</td> </tr> <tr> <td>For 3 million operating cycles</td> <td>35</td> <td>40</td> <td>33</td> </tr> </tbody> </table>	Slow break contact blocks				Power switched in VA				Voltage V	48	110	230	For 1 million operating cycles	450	900	1900	For 3 million operating cycles	170	350	430	Power switched in W				Voltage V	48	110	230	For 1 million operating cycles	100	100	95	For 3 million operating cycles	35	40
Slow break contact blocks																																				
Power switched in VA																																				
Voltage V	48	110	230																																	
For 1 million operating cycles	450	900	1900																																	
For 3 million operating cycles	170	350	430																																	
Power switched in W																																				
Voltage V	48	110	230																																	
For 1 million operating cycles	100	100	95																																	
For 3 million operating cycles	35	40	33																																	





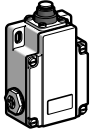
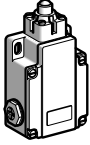

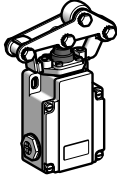
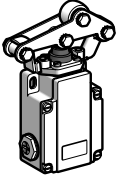



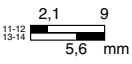
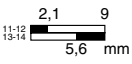
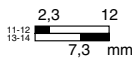
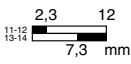
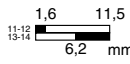
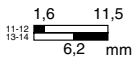

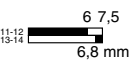
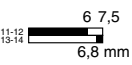
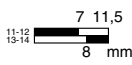
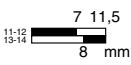
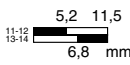
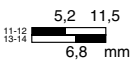

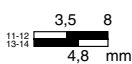
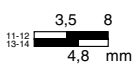
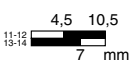
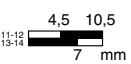
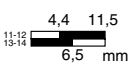
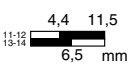

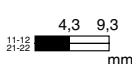
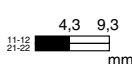
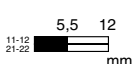
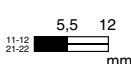

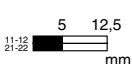
# Limit Switches

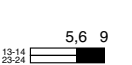
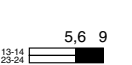
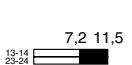
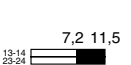
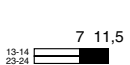
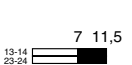
## Osiswitch® Classic, For Material Handling

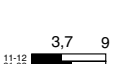
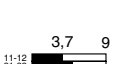
### XC1AC—Complete Switches with Slow-Break Contacts and 1/2" NPT Adapter Included

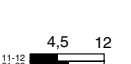
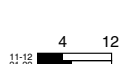

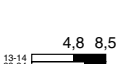
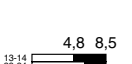
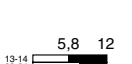
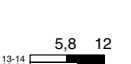
Type of head	Plunger					
						
Type of operator	End plunger	End ball bearing plunger	Roller lever	Offset roller lever	Reinforced roller lever	Roller lever on needle roller bearing

#### Catalog numbers of complete switches

<b>Single pole C/O slow break ZC1AZ11</b> 	<b>XC1AC111</b> 	<b>XC1AC115</b> 	<b>XC1AC116</b> 	<b>XC1AC118</b> 	<b>XC1AC117</b> 	<b>XC1AC119</b> 
<b>2-pole N/C + N/O break before make, slow break ZC1AZ12</b> 	<b>XC1AC121</b> 	<b>XC1AC125</b> 	<b>XC1AC126</b> 	<b>XC1AC128</b> 	<b>XC1AC127</b> 	<b>XC1AC129</b> 
<b>2-pole N/O + N/C make before break, slow break ZC1AZ13</b> 	<b>XC1AC131</b> 	<b>XC1AC135</b> 	<b>XC1AC136</b> 	<b>XC1AC138</b> 	<b>XC1AC137</b> 	<b>XC1AC139</b> 
<b>2-pole N/C + N/C simultaneous, slow break ZC1AZ14</b> 	<b>XC1AC141</b> 	<b>XC1AC145</b> 	<b>XC1AC146</b> 	<b>XC1AC148</b> 	<b>XC1AC147</b> 	<b>XC1AC149</b> 
<b>2-pole N/O + N/O simultaneous, slow break ZC1AZ15</b> 	<b>XC1AC151</b> 	<b>XC1AC155</b> 	<b>XC1AC156</b> 	<b>XC1AC158</b> 	<b>XC1AC157</b> 	<b>XC1AC159</b> 
<b>2-pole N/C + N/C staggered, slow break ZC1AZ16</b> 	<b>XC1AC161</b> 	<b>XC1AC165</b> 	<b>XC1AC166</b> 	<b>XC1AC168</b> 	<b>XC1AC167</b> 	<b>XC1AC169</b> 
<b>2-pole N/O + N/O staggered, slow break ZC1AZ17</b> 	<b>XC1AC171</b> 	<b>XC1AC175</b> 	<b>XC1AC176</b> 	<b>XC1AC178</b> 	<b>XC1AC177</b> 	<b>XC1AC179</b> 
<b>Weight, kg (lb)</b>	0.530 (1.168)	0.530 (1.168)	0.595 (1.312)	0.595 (1.312)	0.870 (1.918)	0.870 (1.918)

**Contact operation**  
 contact closed  
 contact open

#### Complementary characteristics not shown under general characteristics (page 135)

<b>Switch actuation</b>	On end	By 30° cam
<b>Type of actuation</b>		
<b>Maximum actuation speed</b>	0.5 m/s (1.64 ft/s)	<b>Direction A:</b> 1 m/s (3.28 ft/s); <b>Direction B:</b> 0.5 m/s (1.64 ft/s) (1)
<b>Cable entry</b>	3 tapped entries for PG 13 (DIN PG 13.5) conduit thread, clamping capacity 9 to 12 mm (0.35 to 0.47 in.) (2 entries fitted with blanking plug) 1/2" NPT with adapter DE9RA1212	
<b>Connection</b>	Screw terminals. Clamping capacity: min 1 x 0.5 mm <sup>2</sup> , max 1 x 2.5 mm <sup>2</sup>	

1. For a 45° cam the maximum actuation speed becomes 0.5 m/s (1.64 ft/s) and for a 15° cam, 1 m/s (3.28 ft/s).

# Limit Switches

## Osiswitch® Classic, For Material Handling

XC1AC—Complete Switches with Slow-Break Contacts and 1/2" NPT Adapter Included

XC1AC1•1

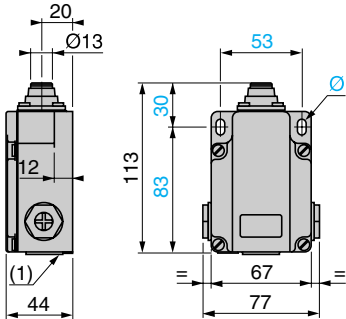

XC1AC1•5

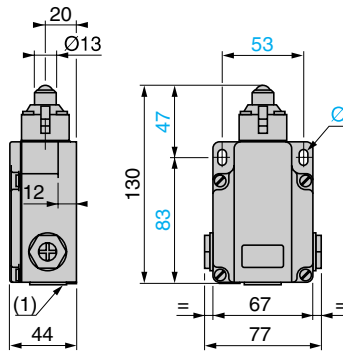

XC1AC1•6

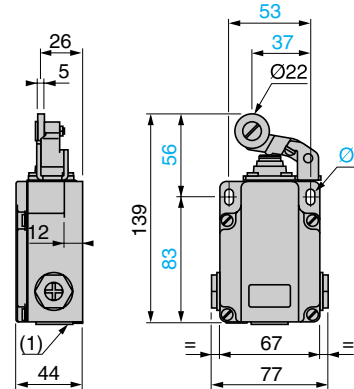

XC1AC1•8

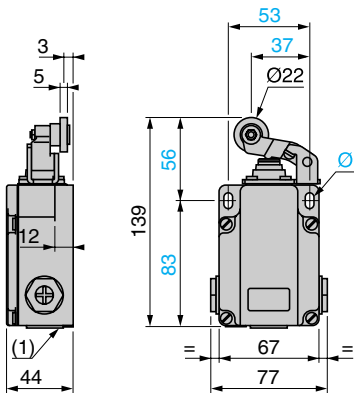

XC1AC1•7, XC1AC1•9

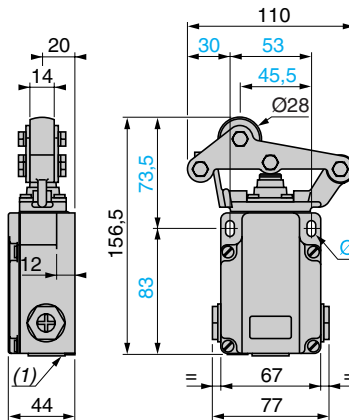

DE9RA1212  
(PG 13 to 1/2" NPT adapter)

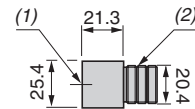

1. Tapped entry for 1/2" NPT conduit
2. PG 13 threaded sleeve

1. 3 tapped entries for PG 13 conduit thread or ISO 20 with adapter DE9RA1620.
- Ø: 2 elongated holes Ø 6.5 x 10.

# Limit Switches

## Osiswitch® Classic, For Material Handling

### XC1AC—Renewal Parts

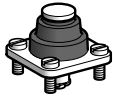

ZC1AC001

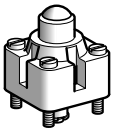

ZC1AC005

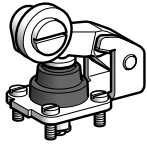

ZC1AC006

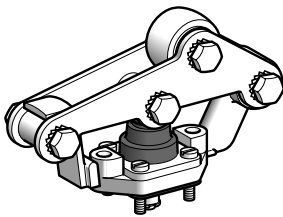

ZC1AC007  
ZC1AC009

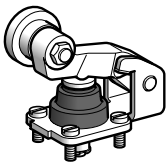

ZC1AC008

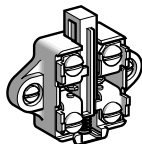

ZC1AZ1•

Plunger heads				
Type of operator	Maximum actuation speed	Type of actuation	Catalog number	Weight kg (lb)
<b>For actuation on end</b>				
End plunger	0.5 m/s (1.64 ft/s)		ZC1AC001	0.035 (0.077)
<b>For actuation by 30° cam</b>				
End ball bearing plunger	0.5 m/s (1.64 ft/s)		ZC1AC005	0.050 (0.110)
Roller lever	Direction A 1 m/s (3.28 ft/s) Direction B 0.5 m/s (1.64 ft/s)		ZC1AC006	0.100 (0.220)
Reinforced roller lever	Direction A 1 m/s (3.28 ft/s) Direction B 0.5 m/s (1.64 ft/s)		ZC1AC007	0.375 (0.827)
Offset roller lever	Direction A 1 m/s (3.28 ft/s) Direction B 0.5 m/s (1.64 ft/s)		ZC1AC008	0.100 (0.220)
Roller lever on needle roller bearing	Direction A 1 m/s (3.28 ft/s) Direction B 0.5 m/s (1.64 ft/s)		ZC1AC009	3.380 (7.452)
Contact blocks				
Type of contact	Function diagram	Catalog number	Weight kg (lb)	
C/O, single pole		ZC1AZ11	0.040 (0.088)	
N/C + N/O break before make		ZC1AZ12	0.045 (0.099)	
N/O + N/C make before break		ZC1AZ13	0.040 (0.088)	
N/C + N/C simultaneous		ZC1AZ14	0.045 (0.099)	
N/O + N/O simultaneous		ZC1AZ15	0.045 (0.099)	
N/C + N/C staggered		ZC1AZ16	0.040 (0.088)	
N/O + N/O staggered		ZC1AZ17	0.040 (0.088)	
Adapter plate				
Description	Catalog number	Weight kg (lb)		
Mounting plate (For replacing an old version type RN-67522 limit switch with an XC1AC limit switch)	ZC1AZ8	3.380 (7.452)		

# Limit Switches

## Osiswitch® Classic, For Material Handling

### XC1AC—Renewal Parts

#### Dimensions

ZC1AC001

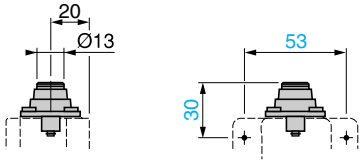

ZC1AC005

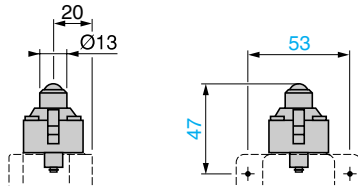

ZC1-AC006

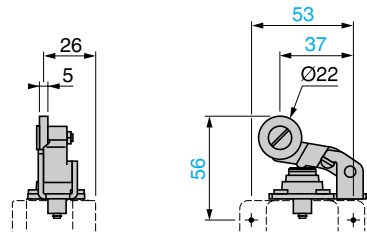

ZC1AC008

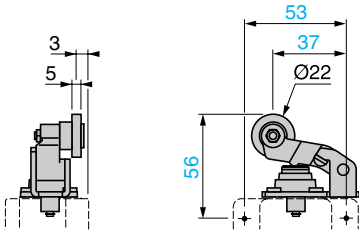

ZC1AC007, AC009

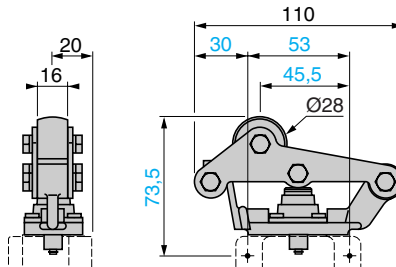

DE9RA1212  
(PG 13 to 1/2" NPT adapter)

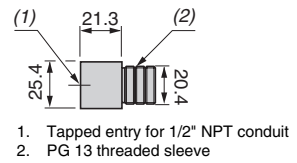

# Limit Switches

## Snap Action Industrial Switches

### Class 9007

#### Industrial Snap Switches and Limit Switches without Enclosures

Industrial Snap Switches have been incorporated in many Square D® products such as timers, specialty push buttons, foot switches, operating mechanisms, door interlocks, motor control centers, position switches, and many other control products.

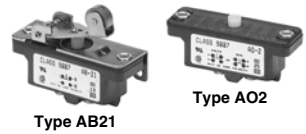

- **Recommended Actuator**—An adjustable actuator is recommended. If a non-adjustable actuator is used, a resilient type or a mechanical stop should be used to prevent bottoming of button mechanism.
- **Adjustable Actuator Overtravel**—Minimum recommended overtravel in both trip and reset directions is 0.015 in. (0.38 mm).
- **Non-Adjustable Actuator Total Travel**—Maximum differential limit plus 0.030 in. (0.76 mm). Example: 0.076 in. (1.9 mm) for Type AO2.
- **Non-Adjustable Actuator Total Travel**—Fully retracted—from mounting surface, at least 0.139 in. (3.5 mm) for Type AO1 and 0.160 in. (4.0 mm) for Types AO2 and CO3. Fully engaged—from mounting surface, at least 0.061 in. (1.5 mm) but not closer than 0.045 in. (1.1 mm).

#### Quick Make and Break

Type of Operator	Contact Arrangement •	Type	Type of Operator	Contact Arrangement •	Type	Type of Operator	Contact Arrangement •	Type	
Basic Snap Switch	1 N.O. 1 N.C.	AO 1	Rigid Roller Lever Type	2 N.O. 2 N.C.	CB 31 (RH) ▲	Roller Plunger Type Panel Mounting Non-Oiltight	1 N.O. 1 N.C.	AP 321	
	1 N.C.	AO 1A			CB 32 (LH) ▲		1 N.C.	AP 324 †	
	1 N.O.	AO 1B			CB 41 ▲ (without Side Mtg. Bracket)		2 N.O. 2 N.C.	CP 321	
	1 N.O. 1 N.C.	AO 2			CB 33 (RH) ◆		2 N.O. 2 N.C.	CP 324 †	
	1 N.C.	AO 6 (Plug-in)			CB 34 (LH) ◆		Operator Only	AP 301 *	
	1 N.C.	AO 2A	Rigid Roller Lever Type One Way Roller	1 N.O. 1 N.C.	AB 25 (RH)	Roller Plunger Type Panel Mounting Oiltight	1 N.O. 1 N.C.	AP 304 † *	
	1 N.O.	AO 2B		1 N.C.	AB 26 (LH)		1 N.O. 1 N.C.	AP 323	
	2 N.O. 2 N.C.	CO 3		2 N.O. 2 N.C.	CB 35 (RH)		1 N.O. 1 N.C.	AP 325 †	
	2 N.O.	CO 6 (Plug-in)	Cabinet Door Type	2 N.O. 2 N.C.	CB 36 (LH)	Roller Plunger Type Panel Mounting Oiltight	2 N.O. 2 N.C.	CP 323	
	Two Stage 2 N.O. 2 N.C.	CO 7		1 N.O. 1 N.C.	AC 1		2 N.O. 2 N.C.	CP 325 †	
Rigid Roller Lever Type	1 N.O. 1 N.C.	AB 21 (RH) ▲	Plunger Type Panel Mounting	1 N.O. 1 N.C.	2 N.O. 2 N.C.	Mushroom Button Type Panel Mounting	1 N.O. 1 N.C.	AP 303 *	
		AB 22 (LH) ▲			1 N.O. 1 N.C.		CC 1	Operator Only	AP 305 † *
		AB 41 ▲ (without Side Mtg. Bracket)			2 N.O. 2 N.C.		CP 221	1 N.O. 1 N.C.	AP 222
		AB 23 (RH) ◆			Operator Only		AP 201 *	2 N.O. 2 N.C.	CP 222
		AB 24 (LH) ◆			Operator Only		AP 202 *	Operator Only	AP 202 *

- Single-pole snap switches that contain two double-break contact elements (1 N.O. and 1 N.C.) must be used on circuits of the same polarity. Two-pole snap switches contain two electrically separated sets of contact elements allowing use on circuits of opposite polarity. Each set contains two double-break contact elements (1 N.O. and 1 N.C.) that must be used on circuits of the same polarity.
- † Roller turned 90° from standard (perpendicular to mounting holes).
- ▲ With 0.22 in. (5.6 mm) width roller.
- ◆ With 0.47 in. (12.0 mm) width roller.
- \* For use with Type AO and CO basic switches.

#### Maximum Current Ratings For Control Contacts—All Types

Switch Type	Contacts	Direct Opening Contacts Meet IEC 60947-5-1 Requirements	Voltage	AC—50 or 60 Hz					Resistive 75% Power Factor	Voltage	DC		AC or DC Continuous Carrying Amperes
				Inductive 35% Power Factor				Make and Break Amperes			Inductive and Resistive Make and Break Amperes		
				Make	Break	Single Pole	Double Pole						
AO1, AC	SPDT Form Z SPST • Form X or Y	No	120	40	4800	15	1800	15	125	0.5	0.25	15	
			240	20	4800	10	2400	10	250	0.25	0.1	15	
			480	10	4800	6	2880	6	600	0.05	—	15	
			600	8	4800	5	3000	5	—	—	—	15	
			—	—	—	—	—	—	—	—	—	—	—
AW, AO2 and AO6, AB, AP	SPDT Form Z SPST • Form X or Y	No	120	40	4800	15	1800	15	125	2.0	0.5	15	
			240	20	4800	10	2400	10	250	0.5	0.2	15	
			480	10	4800	6	2880	6	600	0.1	0.02	15	
			600	8	4800	5	3000	5	—	—	—	15	
			—	—	—	—	—	—	—	—	—	—	—
AW, CO3 and CO6, CB, CC, CP	DPDT Form ZZ DPST Form AA or BB	No	120	30	3600	3	360	3	125	1.0	0.2	10	
			240	15	3600	1.5	360	1.5	250	0.3	0.1	10	
			480	7.5	3600	0.75	360	0.75	600	0.1	—	10	
			600	6	3600	0.6	360	0.6	—	—	—	10	
			—	—	—	—	—	—	—	—	—	—	—

Acceptable Wire Size . . . . . 14–22 AWG  
Recommended Terminal Clamp Torque 6–9 lb-in. (0.7–1 N•m)





# Limit Switches

## Snap Action Industrial Switches

### Class 9007

#### Approximate Dimensions and Operating Data, Types AO, CO, AP, and CP

##### Class 9007 Type AO, Single-Pole Snap Switch

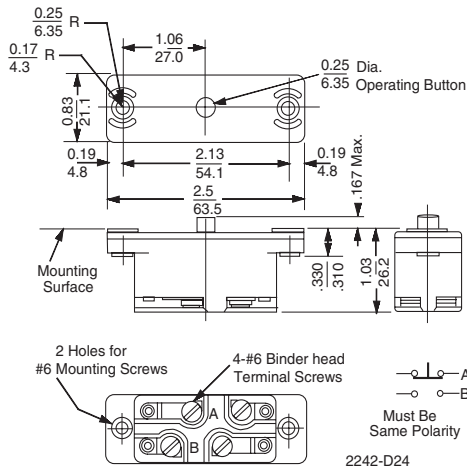

##### Class 9007 Type CO, Two-Pole Snap Switch

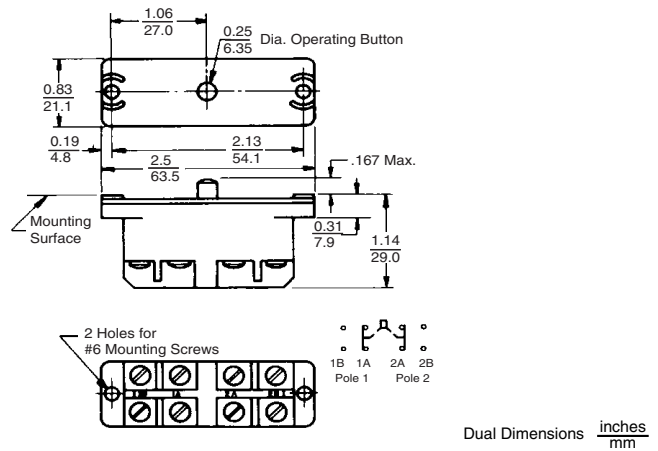

##### Operating Data, in. (mm)

	AO1, 1A, 1B	AO2, 2A, 2B
Pre-travel	0.057–0.074 (1.4–1.8)	0.057–0.074 (1.4–1.8)
Differential	0.015–0.025 (0.6–0.6)	0.035–0.046 (0.9–1.16)
Total travel	0.103–0.125 (2.6–3.2)	0.103–0.125 (2.6–3.2)
Operating force	7–11 oz (0.05–0.08 N)	10–14 oz (0.07–0.1 N)

##### Operating Data, in. (mm)

	CO3	C07
Pre-travel 1st stage	0.057–0.074 (1.4–1.8)	0.035–0.060 (0.9–1.5)
Pre-travel 2nd stage	—	0.060–0.085* (1.5–2.1)
Differential	0.025–0.046 (0.6–1.16)	0.010–0.020 (0.25–0.50)
Total travel	0.103–0.125 (2.6–3.2)	—
Operating force	7–12 oz (0.05–0.084 N)	7–12 oz (0.05–0.084 N)

\* Separation between first and second stage trip points is 0.020–.025 (0.5–0.6).  
 Note: Shipping weight of Type AO and CO is 0.25 lb (0.11 kg).

##### Type AP201, 221, and CP221

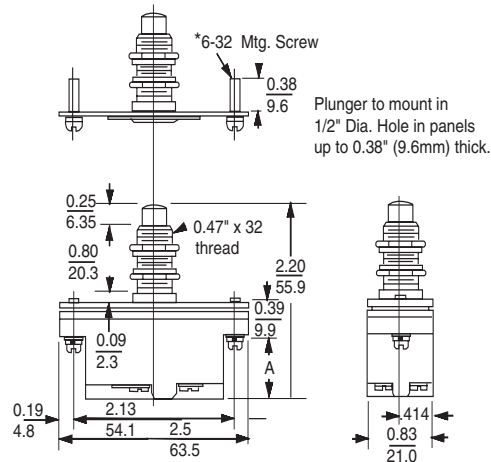

NOTE: Type AP221 shown.

Type	Dimension A
AP221	0.70 (17.8)
CP221	0.80 (20.3)

Operating Data	AP221	CP221
Pretravel	0.070–0.089 (1.8–2.2)	0.070–0.089 (1.8–2.2)
Differential	0.035–0.046 (0.9–1.2)	0.025–0.046 (0.9–1.2)
Overtravel	0.161–0.180 (4.1–4.6)	0.161–0.180 (4.1–4.6)
Total travel	0.231–0.269 (5.8–6.8)	0.231–0.269 (5.8–6.8)
Operating force	10–14 oz (0.07–0.1 N)	7–12 oz (0.05–0.08 N)

##### Type AP301, 303, 304, 305, 321, 323, 324, 325, and CP321, 323, 324, 325

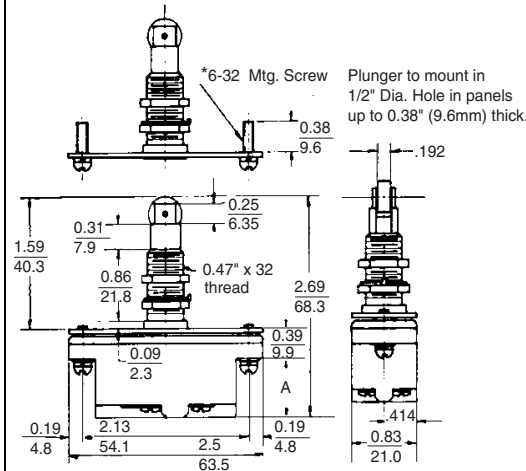

NOTE: Type AP321 shown.

Type	Dimension A
AP321, 323, 324, 325	0.70 (17.8)
CP321, 323, 324, 325	0.80 (20.3)

Operating Data	AP321, 324	AP323, 325	CP321, 324	CP323, 325
Pretravel	0.060–0.150 (1.5–3.8)	0.060–0.150 (1.5–3.8)	0.060–0.150 (1.5–3.8)	0.060–0.150 (1.5–3.8)
Differential	0.035–0.046 (0.9–1.2)	0.035–0.046 (0.9–1.2)	0.025–0.046 (0.9–1.2)	0.035–0.046 (0.9–1.2)
Total travel	0.200–0.340 (5.1–8.6)	0.200–0.340 (5.1–8.6)	0.200–0.340 (5.1–8.6)	0.200–0.340 (5.1–8.6)
Operating force	20 oz (0.14 N)	28 oz (0.2 N)	26 oz (0.18 N)	28 oz (0.2 N)

Note: Shipping weight 0.25 lb (0.11 kg).

# Limit Switches

## Snap Action Industrial Switches

### Class 9007

#### Approximate Dimensions and Operating Data, Types AB, CB, AC, and CC

##### Type AB21 through 24 and CB31 through 34

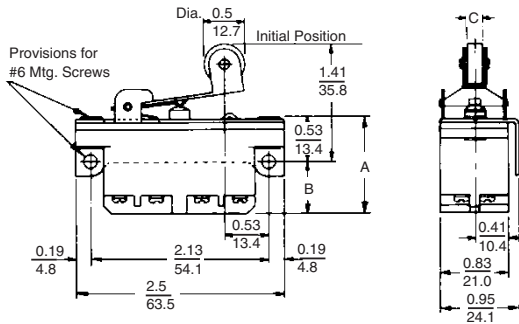

**Note:** Type CB31 RH mounting shown.  
Type AB41 and CB41 same as above except without side mounting plates.

##### Type AB25, 26 and CB35, 36

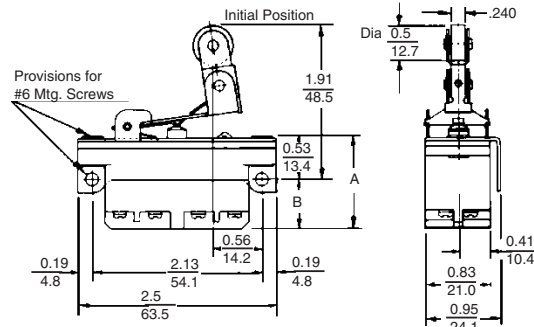

**Note:** Type CB35 mounting shown.

Type	Dimension			Type	Dimension		
	A	B	C		A	B	C
AB21, 22	1.03 (26.2)	0.5 (12.7)	0.22 (5.6)	AB25, 26	1.03 (26.2)	0.5 (12.7)	0.22 (5.6)
AB23, 24	1.03 (26.2)	0.5 (12.7)	0.47 (12.0)	CB35, 36	1.13 (28.7)	0.59 (15.0)	0.22 (5.6)
AB41	1.03 (26.2)	—	0.22 (5.6)				
CB31, 32	1.13 (28.7)	0.59 (15.0)	0.22 (5.6)				
CB33, 34	1.13 (28.7)	0.59 (15.0)	0.47 (12.0)				
CB41	1.13 (28.7)	—	0.22 (5.6)				

#### Operating Data

Pre-travel	0.16 (4.5)
Differential	0.08 (2.0)
Overtravel	0.06 (1.5)
Total travel	0.22 (5.6)
Operating force	8 oz (0.23 kg)

**Note:** Shipping weight 0.25 lb.

##### Type AC1 and CC1

#### Dimensions

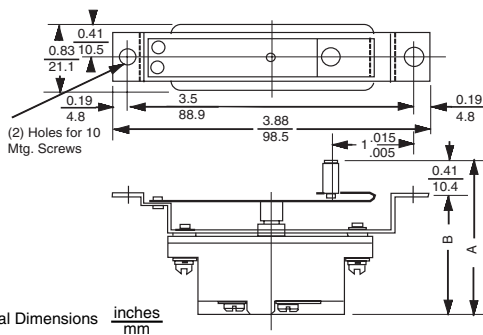

**Note:** Type AC1 shown. Shipping weight 0.25 lb.

#### Operating Data

	AC1	CC1
Pre-travel	0.16 (4.5)	0.16 (4.5)
Differential	0.05 (1.3)	0.07 (1.8)
Overtravel	0.09 (2.3)	0.09 (2.3)
Total travel	0.25 (6.4)	0.25 (6.4)
Operating force	8 oz (0.23 kg)	8 oz (0.23 kg)

Type	Dimension	
	A	B
AC1	1.91 (48.5)	1.5 (38.1)
CC1	2 (50.8)	1.59 (40.4)

**Note:** Shipping weight 0.25 lb.

# Limit Switches

## Miniature

### Class 9007 Type MS and ML



Shown with Standard Bottom Entrance Cable



Shown with 4-Pin Micro-Connector

#### Description

Mini-Switch (MS) miniature switches meet the need for very small, enclosed switches with environmental sealing. A full range of styles are available, including top push plunger, parallel roller plunger, cross roller plunger, rotary lever, and omnidirectional whisker. Factory pre-wiring with industrial grade cable (type SJTO) eliminates the need to remove the cover to wire the switch. Bottom- or side-entrance cable connection is available.

Housings are rugged diecast zinc construction. Excellent sealing is achieved with an epoxy compound encapsulation of the electrical cable connections and switch housing. A Viton® O-ring seal on the plunger keeps liquids from entering the switch cavity.

#### Features

The heavy-duty, completely encapsulated miniature MS limit switch is intended for difficult applications such as machine tools, earth moving equipment, and general transportation. Key features include:

- Symmetrical design and top mounting holes for easy gang mounting of several switches for multiple switching
- Epoxy encapsulation sealing the pre-wired heavy duty #18 AWG SJTO cable and protecting against temporary submersion
- Single-pole double-throw (SPDT) Form C or Form Z, 1 N.O. + 1 N.C. contact
- Fine rotary lever adjustment
- Compact diecast zinc housing
- NEMA Type 6P and IP67 rated
- 10 ampere continuous current rating
- Gold contacts for low level logic switching
- Stainless steel rollers
- UL Listed and CSA Certified
- CE Marking
- Standard temperature range: -40 to +220 °F (-40 to +104 °C)

#### Options

- Gold crosspoint contacts
- Double-break contacts (Type ML only)
- Side-entrance cable or connectors
- Low force (top plunger models only)
- Yellow or gray SJTO cable
- 4- or 5-pin micro-connectors, AC and DC
- #16 AWG SJTO cable
- Tapped 8-32 holes on top of housing

#### Rotary Head

Conventional rotary limit switches have mounting holes in the base or body of the switch. In our rotary design, mounting holes are located in the head also. Cycling and stress forces are transmitted from the shaft in the head directly to the mounting bolts. The strain on the joint between the body and the head is eliminated. The result is a stronger and more rigid mounting, less subject to vibration or a weakness in the joint.

#### Bulkhead Mounted Mini-Switches

The MS housing is designed for multiple switching by gang mounting several switches.

Two mounting holes can be tapped in the top of each switch (except rotary lever) for #8-32 thread bolts. Switches can be readily mounted to any frame or plate by drilling holes through same to accommodate #8-32 bolts and switch plungers. Both sides of the housing are counter-bored for surface mounting.



File E42259  
CCN NKCR



File LR 25490  
Class 3211 03



Marking

# Limit Switches

## Miniature

### Class 9007 Types MS and ML



Shown with Side-Entrance Cable

- 0.98 in. (25 mm) Mounting Hole Centers
- 3 ft (0.9 m) Cable, Standard
- For other available lengths, and for a list of options, see page 154.

General Specifications	
Temperature range	-40 to +220 °F (-40 to +104 °C) The minimum temperatures listed are based on the absence of freezing moisture or water.
Enclosure rating	NEMA Types 1, 2, 4, 6, 6P, 12, 13, IP67
Vibration resistance	10G (75–1200 Hz)
Shock resistance	35G
Cable	#18 AWG SJTO

Contact Characteristics	
Rated thermal current	10 A (standard)
Rated insulation voltage	300 Vac and Vdc (standard)
Gold contact switching ratings	0.1 A, 24 Vdc; 0.24 VA

Type MS Circuit—Form C	Electrical Ratings/SPDT		
	Silver Contacts		Gold Contacts
1 N.O.—1 N.C.	Voltage	Make	Break
	120 AC	60 A	6 A
	240 AC	30 A	3 A
	10.0 Amperes Continuous		100 mA @ 125 Vac 30 mA 28 Vdc
	DC Contact Rating: 5 A (Resistance), 28 Vdc		

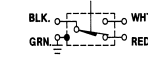

Type ML Circuit—Form Z	Electrical Rating/SPDT-DB		
	Silver Contacts		
1 N.O.—1 N.C.	Voltage	Make	Break
	120 AC	60 A	6 A
	240 AC	30 A	3 A
	10.0 Amperes, Continuous		DC Contact Rating: 5 A (Res), 28 Vdc
	DC Contact Rating: 5 A (Res), 28 Vdc		

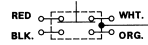

### Description / Functional Diagrams

Top Plunger							
MS	ML	MS	ML	MS	ML	MS	ML
Operating Force/Torque		80 oz (0.6 N)					
Contact		SPDT					
Form		Form C		Form Z		Form Z	
Contact Type		Silver MS01S0100		ML01S0100		MS06S0100	
		Gold MS01G0100		—		MS06G0100	
MS09S0100		—		MS09G0100		—	
Parallel roller plunger							
MS	ML	MS	ML	MS	ML	MS	ML
Operating Force/Torque		80 oz (0.6 N)					
Contact		SPDT					
Form		Form C		Form Z		Form Z	
Contact Type		Silver MS02S0100		ML02S0100		MS07S0100	
		Gold MS02G0100		—		MS07G0100	
MS08S0100		—		MS08G0100		—	
Cross roller plunger							
MS	ML	MS	ML	MS	ML	MS	ML
Operating Force/Torque		80 oz (0.6 N)					
Contact		SPDT					
Form		Form C		Form Z		Form Z	
Contact Type		Silver MS03S0100		ML03S0100		MS08S0100	
		Gold MS03G0100		—		MS08G0100	
MS05S0100		—		MS05G0100		—	
Rotary lever, CW and CCW							
MS	ML	MS	ML	MS	ML	Omnidirectional—wire whisker (NEMA Types 1, 2, 12, 13 only)	
Operating Force/Torque		48 oz-in (0.3 N•m)		15 oz-in (0.1 N•m)			
Contact		SPDT					
Form		Form C		Form Z		Form C	
Contact Type		Silver MS04S0100		ML04S0100		MS05S0100	
		Gold MS04G0100		—		MS05G0100	

# Limit Switches

## Miniature

### Class 9007 Type MS and ML

#### Description / Functional Diagram

Booted Devices								
MS	ML	MS	ML	MS	ML	MS	ML	
Booted top plunger		Booted parallel roller plunger		Booted cross roller plunger				
Operating Force/Torque		80 oz (0.6 N)						
Contact		SPDT						
Form		Form C	Form Z	Form C	Form Z	Form C	Form Z	
Contact Type		Silver	MS10S0100	ML10S0100	MS12S0100	ML12S0100	MS13S0100	ML13S0100
		Gold	MS10G0100	—	MS12G0100	—	MS13G0100	—

Note: See the available options on page 154 and add the designator (up to three) to the end of the catalog number, if applicable. See the example on page 154 for conductor length selection.

#### Lever Arm Selection

There are many styles of levers to accommodate most industrial applications. The levers are diecast metal. The standard roller levers are available with nylon rollers and are also available with steel rollers. See the tables below. Dimensions are given as in. (mm).

#### Style 7 Levers—0.75 in. (19 mm) diameter, nylon or steel roller

Length		Catalog Number 0.25 (6) Wide		Catalog Number 0.5 (13) Wide		Catalog Number 0.75 (19) Wide		Catalog Number 1 (25) Wide	
in.	mm	Nylon	Steel	Nylon	Steel	Nylon	Steel	Nylon	Steel
0.875	22.23	7A2N	7A2	7B2N	7B2	7F2N	—	7J2N	—
1.375	34.93	7A3N	—	7B3N	—	7F3N	—	7J3N	—
1.5	38.10	7A1N	7A1	7B1N	—	7F1N	—	7J1N	—
1.75	44.45	7A7N	—	7B7N	—	7F7N	—	7J7N	—
2.00	50.8	7A4N	—	7B4N	—	7F4N	—	7J4N	—



Lever

#### Style 7X Levers—0.75 in. (19 mm) diameter, nylon or steel roller

Length		Catalog Number 0.25 (6) Wide		Catalog Number 0.5 (13) Wide		Catalog Number 0.75 (19) Wide		Catalog Number 1 (25) Wide	
in.	(mm)	Nylon	Steel	Nylon	Steel	Nylon	Steel	Nylon	Steel
.875	22.23	7XA2N	7XA2	7XB2N	7XB2	7XF2N	—	7XJ2N	—
1.375	34.93	7XA3N	—	7XB3N	—	7XF3N	—	7XJ3N	—
1.5	38.10	7XA1N	7XA1	7XB1N	—	7XF1N	—	7XJ1N	—
1.75	44.45	7XA7N	—	7XB7N	—	7XF7N	—	7XJ7N	—
2.00	50.8	7XA4N	—	7XB4N	—	7XF4N	—	7XJ4N	—

#### Specialty Arms and Options

Description	Length	Diameter	Width	Catalog Number
Style 7D adjustable length, metal roller	1.38 to 3.38 (35 to 85.8)	0.75 (19)	0.25 (6.35)	7D
Style 7D adjustable length, nylon roller	1.38 to 3.38 (35 to 85.8)	0.75 (19)	0.25 (6.35)	7DN
Style 7S spring nylon rod	6 (152.4)	0.3 (7.6)	—	7S
Style 7N nylon rod	5 (127)	0.3 (7.6)	—	7N
Corrosion proof (option available with nylon rollers only)				S *

\* Add "S" to end of catalog number.

Lever Tightening torque: for mounting the lever on the shaft: minimum 17 lb-in (1.9 N•m).

# Limit Switches

## Miniature

### Class 9007 Type MS and ML

## Catalog Number Interpretation and Options

### For Interpretation of the Catalog Number Only

9007 M S 0 1 S 0 1 0 0



9007MS02 Shown with M12 Connector

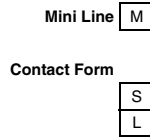

Actuator Type

Top Push Plunger	0 1
Parallel Roller Plunger	0 2
Cross Roller Plunger	0 3
Rotary Lever CW & CCW	0 4
Omnidirectional Wire Whisker	0 5
Bushing Mounted Top Push Plunger	0 6
Bushing Mounted Parallel Roller Plunger	0 7
Bushing Mounted Cross Roller Plunger	0 8
Adjustable Top Push Plunger	0 9
Booted Top Push Plunger	1 0
Booted Parallel Roller Plunger	1 2
Booted Cross Roller Plunger	1 3

### Conductor Length Options

0 0	No Cable
0 1	3 ft (0.9 m) (stranded)
0 2	6 ft (1.8 m)
0 3	9 ft (2.7 m)
0 4	12 ft (3.7 m)
0 5	18 ft (5.5 m)
1 3	33 ft (10 m)

### Contact Type

S	10 A Silver Contacts (standard)
G	Gold Contacts

### Examples

Option	Description
0 2	# 16 AWG SJTO Cable
0 6	Side Entrance 18-4 SJTO Cable
1 0	Gray 18-4 SJTO Cable
1 1	# 18 AWG Individual Conductors
2 1	Low Force (top plunger only) 18 oz.

◆ List options in numerically ascending order. Example: 9007MS01S030621. See other options below.

### Conductor Length

	Designator ■
No cable	00
3 ft (0.9 m)—standard	01
6 ft (1.8 m)	02
9 ft (2.7 m)	03
12 ft (3.7 m)	04
18 ft (5.5 m)	05
33 ft (10 m)	13

### MS Options

(Does not apply to ML except where noted)

	Designator ■
#16 AWG SJTO cable	02
Side entrance, #18 AWG SJTO cable, or Connector 12, 54, 55, 82, 84 *	06
Gray #18 AWG SJTO cable	10
#18 AWG individual conductors	11
Male 4-pin mini-connector with 3 ft (0.9 m) cable (MS only)	12
Low force (NEMA Type 1 only) 18 oz.	21
High Pre-Travel—adds 0.030	30
Male 4-pin micro-connector in housing (DC type) † (no cable) (MS only)	54
Male 5-pin micro-connector in housing (DC type) † (no cable) (ML only)	55
Tapped holes in top of plunger style housing (MS and ML)	81
Male 4-pin micro-connector in housing (AC type) (no cable) (MS only)	82
Black 18/5 SJTO Cable (ML only)	83
Male 4-pin micro-connector in housing (AC type) (no cable) (MS only)	84

■ Ex: 9007MS01S0100 with a 9 ft (2.7 m) cable becomes 9007MS01S0300. 9007MS01S0100 with side entrance becomes 9007MS01S0106.

\* For side entry connectors, include 06, then 12, 54, 55, 82, or 84; otherwise the connector will come from bottom of housing. Example of catalog no. with side entrance connector: 9007MS01S000654. No cable available with 54 and 55. Option 12 is supplied with 3 ft (0.9 m) of cable.

† DC connectors are rated 3 A, 250 Vac/Vdc.

### Male Plug (face) Pin-outs

Option 54 (MS only)	Option 55 (ML only)	Option 12 (MS only)	Option 82 (MS only)	Option 84 (MS only)

# Limit Switches

## Miniature

### Class 9007 Type MS and ML

#### Dimensions

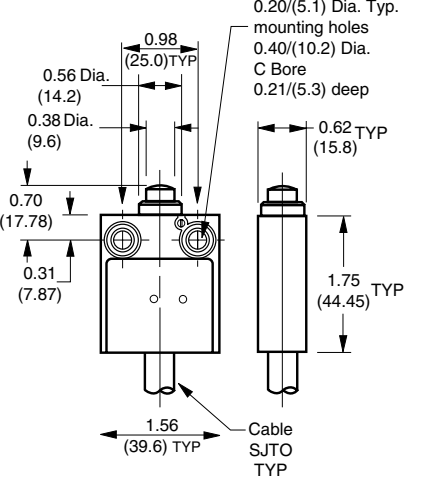
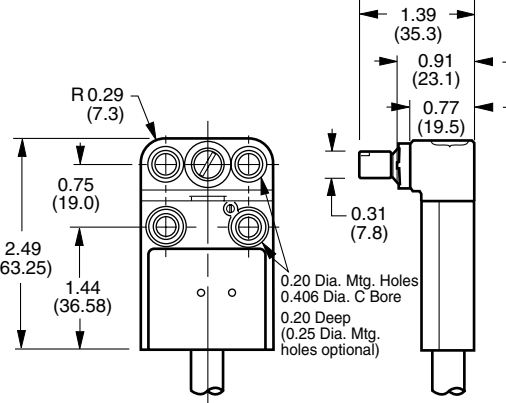
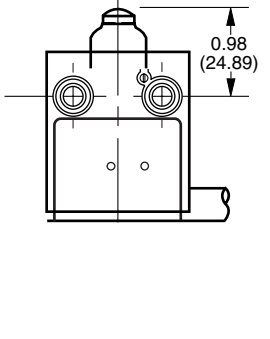
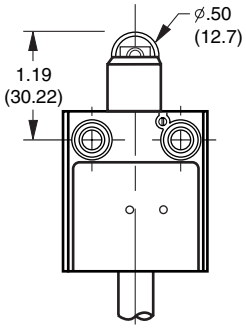
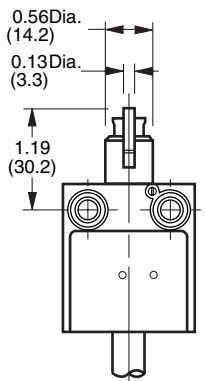
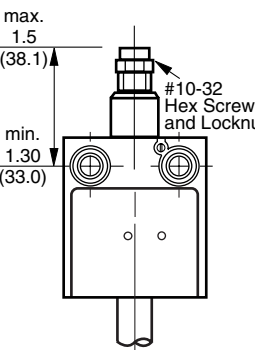
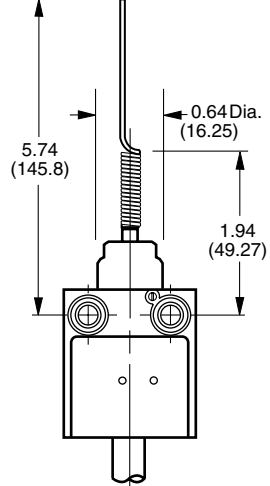
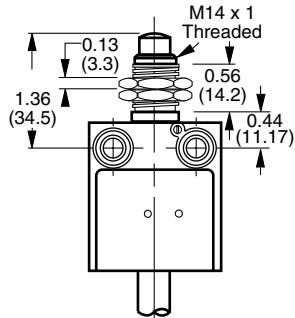
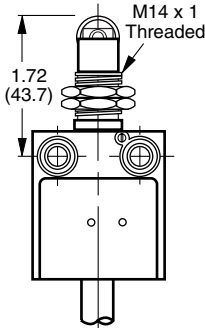
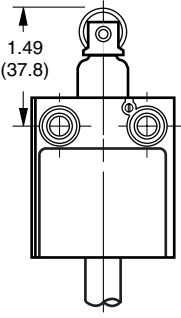
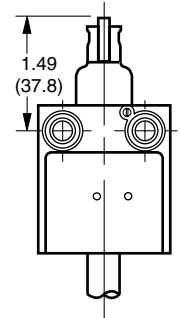
Top Push Plunger	Rotary Lever	Booted Top Push Plunger with Mid-Side Entry Cable	
 <p>MS01, MLO1</p>	 <p>MSO4, ML04</p>	 <p>Dual Dimensions <u>inches</u> <u>mm</u></p> <p>MS10, ML10</p>	
 <p>MS02, ML02</p>	 <p>MS03, ML03</p>	 <p>MS09, ML09</p>	 <p>MS05, ML05</p>
 <p>MS06, ML06</p>	 <p>MS07, ML07</p>	 <p>MS12, ML12</p>	 <p>MS13, ML13</p>

Limit Switches



# Limit Switches

## Miniature Enclosed Reed

### Class 9007 Type XA



Straight Plunger



Roller Plunger



Cross Roller Plunger

Limit Switches

### Description and Specifications

Sealed construction keeps contaminants out of the contact area, making it the ideal choice for low voltage, low current circuits used by programmable controllers.

Type XA is designed for use in applications where contact reliability, environmental immunity, small size, or low cost are required.

#### NOTE:

- Because reed switches are operated by a magnet, they should not be installed in areas where strong magnetic fields may be present. The devices should always be checked for proper operation after installation.
- Type XA **cannot be used in Division 2 locations** since the National Electrical Code (NEC) requires provisions for conduit connection. The Type C reed switches have this provision for conduit but the Type XA do not.

Cable Length* ft (m)	Straight Plunger		Roller Plunger		Cross Roller Plunger	
	N.O. Type	N.C. Type	N.O. Type	N.C. Type	N.O. Type	N.C. Type
3 (0.9)	XA7303E	XA7503E	XA7303D	XA7503D	XA7303DC	XA7503DC
6 (1.8)	XA7306E	XA7506E	XA7306D	XA7506D	XA7306DC	XA7506DC
9 (2.7)	XA7309E	XA7509E	XA7309D	XA7509D	XA7309DC	XA7509DC

\* Other cable lengths are available. Order by changing the last two numerical digits of the Type number to the length desired.  
Example: An XA7303E with 15 ft (4.5 m) of cable would become an XA7315E.

### Operating Data

Dimensions in. (mm)	Top Push Rod (Type E)	Roller Plunger (Types D, DC)
Initial position (D)	0.690 (17.5)	1.190 (30.2)
Trip position (B)	0.620 (15.7)	1.120 (28.4)
Pre-travel (E)	0.07 (1.8)	0.07 (17.8)
Reset position (C) maximum	0.655 (16.6)	1.155 (29.3)
Differential (F)	0.015 (0.38)	0.015 (0.38)
Final position (A)	0.492 (12.5)	0.992 (25.2)
Total stroke	0.198 (5.0)	0.198 (5.0)
<b>Operating force (max.)</b>	<b>2.75 lb (0.31 N)</b>	<b>2.75 lb (0.31 N)</b>

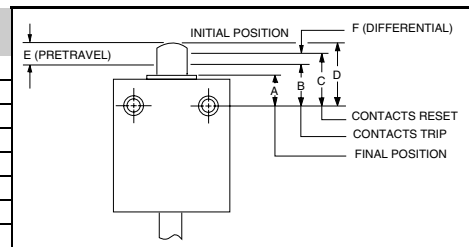

<b>Contacts</b>	The contact is a fully encapsulated, hermetically sealed reed, suitable for controlling solid-state loads as well as industrial relays. Switches can also be used as inputs to intrinsically safe systems. Use of a transient suppressor extends the life of the switch when used on heavy electrical loads.
<b>Enclosure Construction</b>	Diecast zinc—baked, gray enamel finish. Meets NEMA Types 2, 4, 4X, 6P, 12 and 13 requirements. Oil-tight, dust-tight, water-tight, and submersible.
<b>Cable</b>	SJTOWA jacketed cable with 18 gauge wire.
<b>Ambient Temperature</b>	-20 to +140 °F (-28.9 to +60 °C).
<b>Agency Listings</b>	UL: File E42259 CCN NKCR      CSA: File LR 25490, Class 3211 03

NOTE: The XA switch is available with a 3 ft (0.9 m) cable and 3-pin Brad Harrison male connector No. 40904 (or equivalent), Form Y190.

### Maximum Current Ratings for Control Circuit Contacts—Type XA

AC—50/60 Hz						DC		
Volts	Inductive (35% Power Factor)			Continuous Carrying Amperes	Resistive (75% Power Factor) Make, Break, and Continuous Carrying Amperes	Volts	Resistive	
	Make	Break	Continuous Carrying Amperes				Make and Break Amperes Single Throw	Continuous Carrying Amperes
120	2.0	240	0.2	24	0.5	120	0.2	0.5
240	1.0	240	0.1	24	0.5	—	—	—

### Contact Diagrams

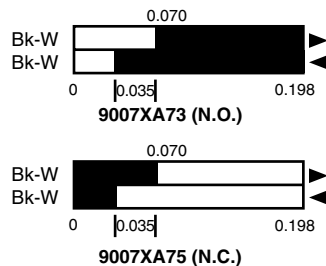

### Dimensions

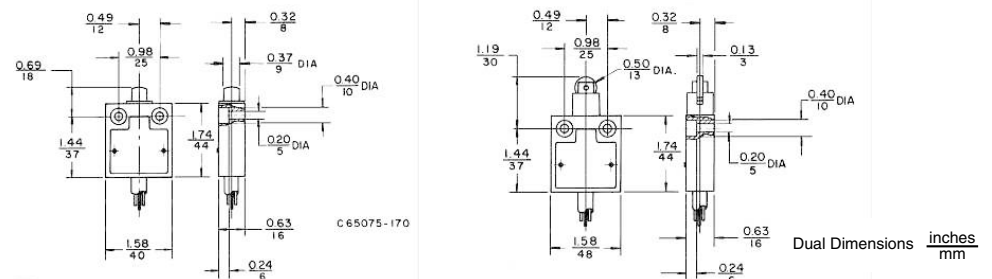



# Limit Switches

## 9007AW Heavy Duty Industrial Precision, Oiltight



Lever Arm Type



Plunger Type

Dual Dimensions  $\frac{\text{inches}}{\text{mm}}$

### Lever Arm And Plunger Types

Select Switch		Lever Arm Type Without Lever Arm. Select from CCW Operation ■	Select Operator	
Mounting	Contacts	Type	Roller Plunger Type With Micrometer Adjustment	Push Rod Plunger Type With Micrometer Adjustment
Surface Mounting Plug-in	1 N.O.—1 N.C.	AW16	AW36	AW46
	2 N.O.	‡	—	—
	2 N.C.	AW19‡	—	—
Surface Mounting Nonplug-in Standard Box	1 N.O.—1 N.C.	AW12	AW32	AW42
Surface Mounting Nonplug-in Deep Box	1 N.O.—1 N.C.	AW14	—	—
	2 N.O.—2 N.C.	AW18	AW38	—
Open Type (Without Box) Plug-in	1 N.O.—1 N.C.	AO16	AO36	—
	2 N.O.	‡	—	—
	2 N.C.	‡	—	—
Open Type (Without Box) Nonplug-in	1 N.O.—1 N.C.	AO12	—	—
	2 N.O.—2 N.C.	AO18	—	—
Flush Mounting	1 N.O.—1 N.C.	AF12	—	—

Nominal Operating Data	in. (mm)		in. (mm)	
	Pre-travel	5°	0.09 (2.3)	0.09 (2.3)
Total-travel	30°	0.25 (6.3) ±0.06 (1.5) Adjustable	0.25 (6.3) ±0.06 (1.5) Adjustable	
Differential	2.5°	0.05 (1.3)	0.05 (1.3)	
Reverse Over-travel	25°	—	—	
Operating Torque or Force	2.75 lb-in (0.31 N•m)	3 lb-in (0.34 N•m)	3 lb-in (0.34 N•m)	
Repeat Accuracy	±0.002 (0.05) Linear travel of cam on 1.38 (35) lever arm	±0.001 (0.02)	±0.001 (0.02)	

■ Field convertible to CW operation.

‡ 2 N.O. contact only when Type AW19 is operated in clockwise direction. 2 N.C. contacts only when Type AW19 is operated in counterclockwise direction.

Lever arms, see page 186.

### Approximate Dimensions

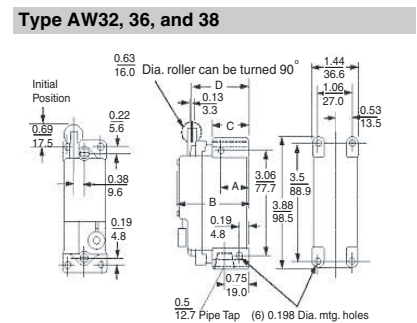
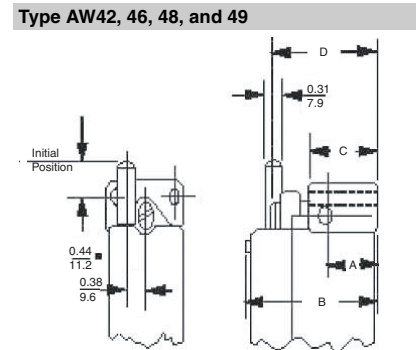
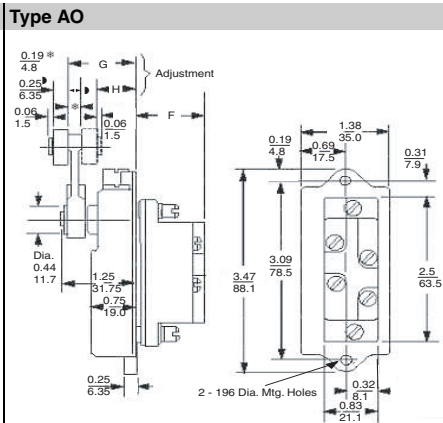
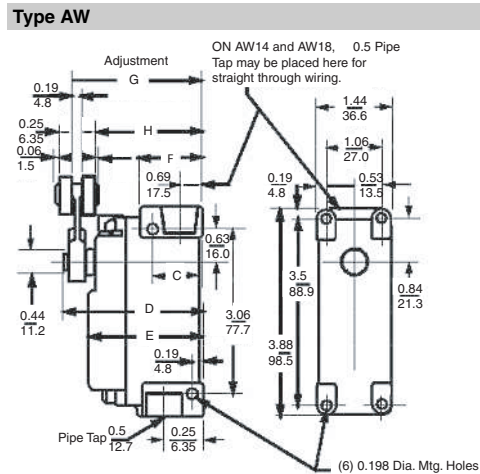

Type	C	D	E	F	G	H
AW12	0.31 (7.9)	2.69 (68.3)	2.19 (56)	1.16 (29.4)	2.5–2.56 (63.5–65)	2.06–2.13 (52.3–54)
AW14	—	—	—	—	—	—
AW16	1.25 (32)	3 (76)	2.5 (63.5)	1.47 (37)	2.81–2.88 (71–73)	2.38–2.44 (60–62)
AW18	—	—	—	—	—	—
AW19	—	—	—	—	—	—
AO12	—	—	—	1.03 (26)	1.06–1.13 (27–29)	0.63–0.69 (16–17.5)
AO18	—	—	—	1.13 (29)	1.06–1.13 (27–29)	0.63–0.69 (16–17.5)

Type	A	B	C	D
AW32 and AW42	0.31 (7.9)	2.22 (56)	1.16 (29.4)	1.81 (46)
AW36, 38, 46, 48, and 49	1.25 (32)	2.53 (64)	1.47 (37.3)	2.13 (5.4)

# Limit Switches

## 9007C Heavy Duty Industrial—Plug-in Body, Metal Standard and Compact

### Standard plug-in body type with 1 cable entry (1)

The standard plug-in body types with one cable entry are also available with reed contacts

#### With reed contacts

### With head for linear movement side plunger

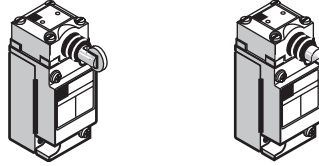

Page 160  
Page 164

### top plunger

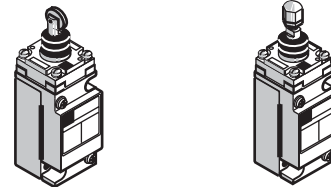

Page 161  
Page 169

### With head for rotary movement (lever)

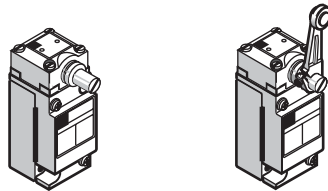

Page 162  
Page 166

### With head for multi-directional movement

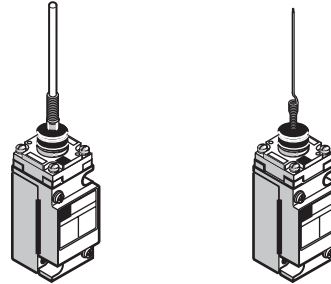

Page 163  
Page 167

#### With reed contacts

### Compact plug-in body type with one cable entry (1)

### With head for linear movement Side plunger

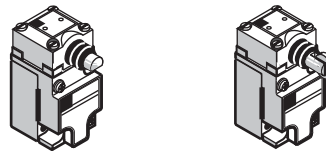

Page 168

### Top plunger

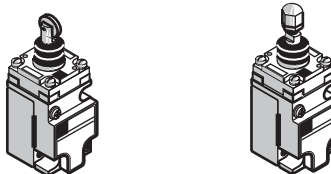

Page 169

### With head for rotary movement (lever)

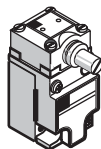

Page 170

### With head for multi-directional movement

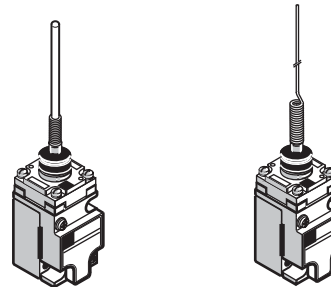

Page 171

1. Factory modifications: see pages 172 to 176

# Limit Switches

## 9007C Heavy Duty Industrial—Plug-in Body, Metal Standard and Compact

Environmental characteristics		
<b>Conforming to standards</b>	Products	NEMA 250, EN 60947-1, EN 60947-5-1, IEC 60947, UL 508, C22-2-14-95, CE conformity documentation
<b>Product certifications</b>		UL, CSA, CE
<b>Protective treatment</b>		Epoxy powder coat (additional protection available)
<b>Ambient air temperature</b>	Operation	-20...+185 °F (-28.9...+85 °C), wider range available
	Storage	-20...+185 °F (-28.9...+85 °C), wider range available
<b>Vibration resistance</b>	Conforming to IEC 60068-2-6	25 gn (10...150 Hz, 11 ms) (Reed switch good for 18.5g only)
<b>Shock resistance</b>	Conforming to IEC 60068-2-27	60 gn (9 ms) 40 gn (9 ms) for reed switch
<b>Electric shock protection</b>	Conforming to IEC 61140	Class 0
<b>Degree of protection</b>	Conforming to IEC 60529	IP 67
<b>Cable entry or connector (1)</b>	Depending on model	1/2-14 NPT, M20 x 1.5, ISO cable entry, 5-pin mini connector, 4-pin micro connector
<b>Materials</b>	Bodies, heads, levers	Bodies and heads in Zamak® zinc alloy, levers and rods in zinc, steel, stainless steel, Delrin® resin.

1. A wide range of connectors are available. Contact your local field office.

Contact block characteristics		
<b>Rated operational characteristics hard contacts -AC Voltage</b> (top half of body)	9007CO52 (compact single)	NEMA A600 (Ue = 600 V, Ie = 1.2 A); Ithe = 10 A
	9007CO54 (single pole)	NEMA A600 (Ue = 600 V, Ie = 1.2 A); Ithe = 10 A
	9007CO62 (two pole)	NEMA A600 (Ue = 600 V, Ie = 1.2 A); Ithe = 10 A
	9007CO66 (two pole two stage)	NEMA A600 (Ue = 600 V, Ie = 1.2 A); Ithe = 10 A
	9007CO68 (two pole neutral)	NEMA A600 (Ue = 600 V, Ie = 1.2 A); Ithe = 10 A
	<b>Reed switches, complete body</b>	9007C84 (1 N.O.)
9007C86 (1 N.C.)		NEMA C600 (Ue = 600 V, Ie = 0.3 A); Ithe = 2.5 A
<b>Rated operational characteristics hard contacts -DC Voltage</b> (top half of body)	9007CO52 (compact single)	NEMA Q600 (Ue = 600 V, Ie = 0.1 A); Ithe = 2.5 A
	9007CO54 (single pole)	NEMA Q600 (Ue = 600 V, Ie = 0.1 A); Ithe = 2.5 A
	9007CO62 (two pole)	NEMA R300 (Ue = 250 V, Ie = 0.11 A); Ithe = 1.0 A
	9007CO66 (two pole two stage)	NEMA R300 (Ue = 250 V, Ie = 0.11 A); Ithe = 1.0 A
	9007CO68 (two pole neutral)	NEMA R300 (Ue = 250 V, Ie = 0.11 A); Ithe = 1.0 A
	<b>Reed switches, complete body</b>	9007C84 (1 N.O.)
9007C86 (1 N.C.)		NEMA Q150 (Ue = 125 V, Ie = 0.55 A); Ithe = 2.5 A
<b>Rated insulation voltage</b>		600 V
<b>Rated Impulse Withstand Voltage</b>		2,500 Vac for 1 minute for CE; 2,200 Vac for 1 minute for UL; and 2,640 Vac for 1 s for CSA
<b>Positive Opening</b>	Special Y1561	Special Y1561 (one pole slow break only) →
<b>Short Circuit Protection</b>		10 A. Bussman Class CC KTK-R-10 fuse non-time-delay
<b>Terminal wire sizes (Cabling/Screw Clamp)</b>		1 or 2, 12–22 AWG (2.05–0.644 mm <sup>2</sup> ) wires maximum
<b>Maximum Actuation Speed</b>		15.2 mpm / 27.4 mpm (50 fpm / 90 fpm) with 45 degree cam angle, levers only
<b>Electrical Durability</b>		1 million operating cycles







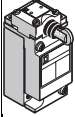

### Types of contact elements

Example: 9007C54 single-pole limit switch, Form Z, same polarity

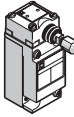
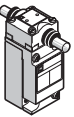
IEC 60947-5-1			NEMA			JIS		
Form	Symbol	Description	Form	Symbol	Description	Form	Symbol	Description
A		Single break	A		—	3		Double break
X		—						
B		Single break	B		—	2		Double break
Y		—						
C		—	C		—	1		Single break
Za		Same polarity	Z		"Same polarity" only			Double break
Zb		Electrically separate						

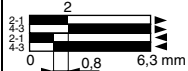
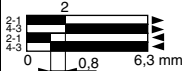
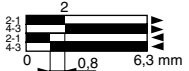
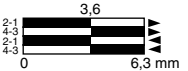
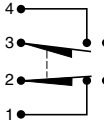
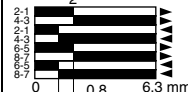
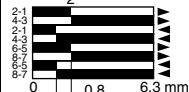
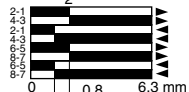
# Limit Switches

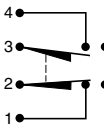
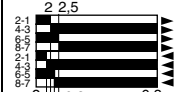
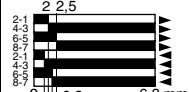
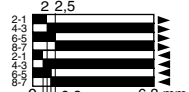
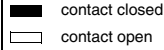
## 9007C Heavy Duty Industrial—Plug-in Body, Metal Standard Body

Type of head	Side Plunger (mounting by the body)			
Standard plug-in body type				
Type of operator	Side roller plunger, spring return, vertical roller (1)	Side push rod plunger, spring return	Side push rod plunger, adjustable (2) spring return	Side push rod plunger, maintained contact
<b>Catalog numbers</b>				
1 N.O. 1 N.C. snap action 	<b>9007C54F</b> 	<b>9007C54G</b> 	<b>9007C54GD</b> 	<b>9007C54H</b> 
2 N.O. 2 N.C. snap action 	<b>9007C62F</b> 	<b>9007C62G</b> 	<b>9007C62GD</b> 	<b>9007C62H</b> 
2 N.O. 2 N.C. Two stage snap action 	<b>9007C66F</b> 	<b>9007C66G</b> 	<b>9007C66GD</b> 	
Weight, kg (lb)	0.568 (1.25)	0.568 (1.25)	0.568 (1.25)	0.568 (1.25)
Contact operation				
<b>Characteristics (nominal operating data)</b>				
Switch actuation	On end			
Type of actuation				
Pre-travel	2 mm (0.08")			3.6 mm (0.14")
Pre-travel two Stage	First stage	2 mm (0.08")		
	First stage to second stage	0.5 mm (0.02")		
Total travel	6.3 mm (0.25")			
Differential	0.8 mm (0.03")			
Reverse overtravel	-			
Minimum force or torque	1 pole & 2 pole	4 lb (17.8 N)		7 lb (31.1 N)
Terminal wire sizes (Cabling/Screw Clamp)	1 or 2, 12–22AWG (2.05–0.644 mm <sup>2</sup> ) wires maximum			
Repeatability (linear travel of cam)	0.03 mm (0.001")			-
Cable entry	1/2-14 NPT standard, optional M20 x 1.5 mm for ISO cable entry			

- Can be converted to horizontal roller type in the field. To order horizontal roller version add the letter H at the end of the equivalent vertical roller version type.
- To lock the nut in the desired position, crimp the slot near the bottom of the nut.

Dimensions:  
pages 178 to 181

# Limit Switches

## 9007C Heavy Duty Industrial—Plug-in Body, Metal Standard Body

Type of head **Top Plunger (mounting by the body)**

Standard plug-in body type



Type of operator	Top roller plunger spring return	Top push rod plunger spring return	Top push rod plunger adjustable (1) spring return	Palm operated (2)
<b>Catalog numbers</b>				
<b>1 N.O. 1 N.C. snap action</b> 	<b>9007C54D</b> 	<b>9007C54E</b> 	<b>9007C54ED</b> 	<b>9007C54R (2)</b> 
<b>2 N.O. 2 N.C. snap action</b> 	<b>9007C62D</b> 	<b>9007C62E</b> 	<b>9007C62ED</b> 	<b>9007C62R (2)</b> 
<b>2 N.O. 2 N.C. Two stage snap action</b> 	<b>9007C66D</b> 	<b>9007C66E</b> 	<b>9007C66ED</b> 	<b>9007C66R (2)</b> 
<b>Weight, kg (lb)</b>	0.568 (1.25)	0.568 (1.25)	0.568 (1.25)	0.568 (1.25)

**Contact operation**

### Characteristics (nominal operating data)

<b>Switch actuation</b>	On end	
<b>Type of actuation</b>		
<b>Pre-travel</b>	2 mm (0.08")	
<b>Pre-travel two Stage</b>	First stage	2 mm (0.08")
	First stage to second stage	0.3 mm (0.01")
<b>Total travel</b>	6.3 mm (0.25")	
<b>Differential</b>	0.5 mm (0.02")	
<b>Reverse overtravel</b>	-	
<b>Minimum force or torque</b>	1 pole & 2 pole	3 lb (13.3 N) <span style="float: right;">7 lb (31.1 N)</span>
<b>Terminal wire sizes (Cabling/Screw Clamp)</b>	1 or 2, 12–22 AWG (2.05–0.644 mm <sup>2</sup> ) wires maximum	
<b>Repeatability (linear travel of cam)</b>	0.03 mm (0.001")	
<b>Cable entry</b>	1/2-14 NPT standard, optional M20 x 1.5 mm for ISO cable entry	

- To lock the nut in the desired position, crimp the slot near the bottom of the nut.
- Does not include mushroom button. Must be ordered separately see page 185.

Dimensions:  
pages 178 to 181

# Limit Switches

## 9007C Heavy Duty Industrial—Plug-in Body, Metal Standard Body

Type of head	Rotary (lever arm type) (1)					
Standard plug-in body type						
Type of operator	Standard pre-travel, spring return	Low differential, spring return	Neutral position Standard pre-travel, spring return		Light operating torque spring return	Maintained contact
Type of direction	CW & CCW (2)	CW & CCW (2)	CW & CCW	CW & CCW	CW & CCW (2)	CW (trip) CCW (reset)
<b>Catalog numbers</b>						
1 N.O., 1 N.C. snap action 	<b>9007C54B2</b> 	<b>9007C54A2</b> 			<b>9007C54N2</b> 	<b>9007C54C</b> 
2 N.O., 2 N.C. snap action 	<b>9007C62B2</b> 	<b>9007C62A2</b> 			<b>9007C62N2</b> 	<b>9007C62C</b> 
2 N.O., 2 N.C. snap action Neutral position 			<b>9007C68T10</b> 	<b>9007C68T5</b> 		
2 N.O., 2 N.C. Two stage snap action 	<b>9007C66B2</b> 	<b>9007C66A2</b> 			<b>9007C66N2</b> 	
Weight, kg (lb)	0.568 (1.25)	0.568 (1.25)	0.568 (1.25)	0.568 (1.25)	0.568 (1.25)	0.568 (1.25)
Contact operation	contact closed		contact open			
<b>Characteristics (nominal operating data)</b>						
Switch actuation	By 30° cam					
Type of actuation						
Pre-travel	10°	5°	10°	5°	10°	45°
Pre-travel two stage						
First stage	10°	5°	—	—	10°	—
First stage to second stage	2.5°	1.5°	—	—	2.5°	—
Total travel	90°	—	—	—	—	90°
Differential	4°	2°	4°	2°	4°	—
Reverse overtravel	90°	—	—	—	—	—
Operating torque/force 1 pole & 2 pole	4 lb-in (0.45 N•m)				25 oz-in (0•18 N•m)	3 lb-in (0.34 N•m)
Terminal wire sizes (Cabling/Screw Clamp)	1 or 2, 12–22 AWG (2.05–0.644 mm <sup>2</sup> ) wires maximum					
Repeatability (linear travel of cam)	0.05 mm (± 0.002")	0.03 mm (± 0.001")	0.05 mm (± 0.002")	0.05 mm (± 0.002")	0.05 mm (± 0.002")	0.05 mm (± 0.002")
Cable entry	1/2-14 NPT standard, optional M20 x 1.5 mm for ISO cable entry					

- Lever arm type must be ordered separately from pages 186 to 191.
- These devices are factory set to operate the contacts in **both** the CW and CCW directions. **Mode of operation** is field convertible to CW only or CCW only. **To order factory converted devices:** For CCW only operation, change the 2 at the end of the Type number to 1 (for example, C54B2 becomes C54B1). For CW only operation, delete the 2 at the end of the Type number (for example C54B2 becomes C54B).

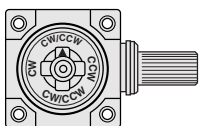

Mode of operation of the lever arm is easily convertible to clockwise or both. Simply pull out and rotate the arrow to the letters representing the desired direction—CW, CCW, or CW/CCW.

Dimensions:  
pages 178 to 181

# Limit Switches

## 9007C Heavy Duty Industrial—Plug-in Body, Metal Standard Body

Type of head **Flexible operator (wobble stick)**

Standard plug-in body type

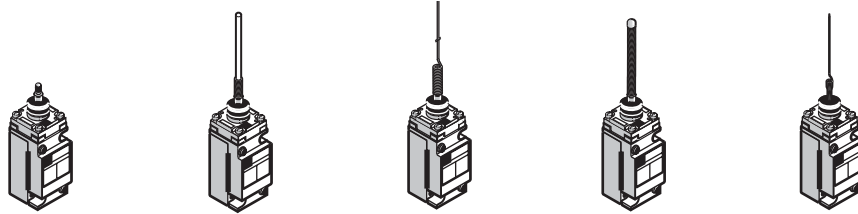

Type of operator	Universal (1)	Wobble stick Delrin® extension (1)	Wobble stick wire extension (1)	Wobble stick coil spring extension (1)	Cat whisker
------------------	---------------	------------------------------------	---------------------------------	--	-------------

### Catalog numbers

<b>1 N.O. 1 N.C. snap action</b> 	<b>9007C54JKC</b> 	<b>9007C54J</b> 	<b>9007C54K</b> 	<b>9007C54KC</b> 	<b>9007C54L</b> 
<b>2 N.O. 2 N.C. snap action</b> 	<b>9007C62JKC</b> 	<b>9007C62J</b> 	<b>9007C62K</b> 	<b>9007C62KC</b> 	<b>9007C62L</b> 
<b>2 N.O. 2 N.C. Two stage snap action</b> 	<b>9007C66JKC</b> 	<b>9007C66J</b> 	<b>9007C66K</b> 	<b>9007C66KC</b> 	<b>9007C66L</b> 
<b>Weight, kg (lb)</b>	0.568 (1.25)	0.568 (1.25)	0.568 (1.25)	0.568 (1.25)	0.568 (1.25)

**Contact operation**

### Characteristics (nominal operating data)

<b>Switch actuation</b>	Object from any direction	
<b>Type of actuation</b>		
<b>Pre-travel</b>	10° (any direction)	20°
<b>Pre-travel two stage</b>		
First stage	10° (any direction)	20°
First stage to second stage	4°	5°
<b>Total travel</b>	90°	
<b>Differential</b>	3	6°
<b>Reverse overtravel</b>	-	
<b>Operating torque/force 1 pole &amp; 2 pole</b>	3 lb-in (0.34 N•m)	7 oz-in (0.05 N•m)
<b>Terminal wire sizes (Cabling/Screw Clamp)</b>	1 or 2, 12–22 AWG (2.05–0.644 mm <sup>2</sup> ) wires maximum	
<b>Repeatability (linear travel of cam)</b>	-	
<b>Cable entry</b>	1/2-14 NPT standard, optional M20 x 1.5 mm for ISO cable entry	

1. Wobble stick extensions are available separately for the universal head. See page 185.

Dimensions:  
pages 178 to 181

# Limit Switches

## 9007C Heavy Duty Industrial—Plug-in Body, Metal Standard Body—Reed Contacts

Type of head Side Plunger (mounting by the body)

Standard plug-in body type



Type of operator	Side roller plunger spring return vertical roller (1)	Side push rod plunger spring return	Side push rod plunger adjustable (2) spring return	Side push rod plunger maintained contact
------------------	---	-------------------------------------	--	--

### Catalog numbers

1 N.O. Reed contacts snap action 	<b>9007C84F</b> 	<b>9007C84G</b> 	<b>9007C84GD</b> 	<b>9007C84H</b> 
--------------------------------------	---------------------	---------------------	----------------------	---------------------

1 N.C. Reed contacts snap action 	<b>9007C86F</b> 	<b>9007C86G</b> 	<b>9007C86GD</b> 	<b>9007C86H</b> 
--------------------------------------	---------------------	---------------------	----------------------	---------------------

Weight, kg (lb)	0.568 (1.25)	0.568 (1.25)	0.568 (1.25)	0.568 (1.25)
-----------------	--------------	--------------	--------------	--------------

Contact operation				
-------------------	--	--	--	--

### Characteristics (nominal operating data)

Switch actuation	On end		
Type of actuation			
Pre-travel	2.8 mm (0.110")	3.6 mm (0.14")	
Total travel	6.3 mm (0.25")		
Differential	1.8 mm (0.07")	-	
Reverse overtravel	-		
Minimum force or torque 1 pole & 2 pole	4 lb (17.8 N)	7 lb (31.1 N)	
Terminal wire sizes (Cabling/Screw Clamp)	1 or 2, 12–22 AWG (2.05–0.644 mm <sup>2</sup> ) wires maximum		
Repeatability (linear travel of cam)	0.076 mm (± 0.003")	-	
Cable entry	1/2-14 NPT standard, optional M20 x 1.5 mm for ISO cable entry		







- Can be converted to horizontal roller type in the field. To order horizontal roller version add the letter **H** at the end of the equivalent vertical roller version type.
- To lock the nut in the desired position, crimp the slot near the bottom of the nut.

Dimensions:  
pages 178 to 181

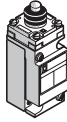
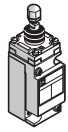
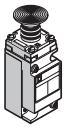

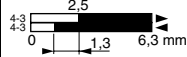
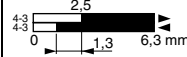
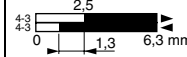
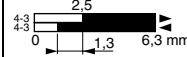
# Limit Switches

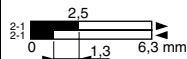
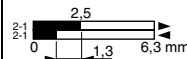
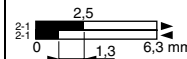
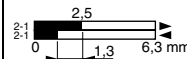
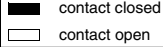
## 9007C Heavy Duty Industrial—Plug-in Body, Metal Standard Body—Reed Contacts

Type of head	Top Plunger (mounting by the body)			
Standard plug-in body type				
Type of operator	Top roller plunger spring return	Top push rod plunger spring return	Top push rod plunger adjustable (1) spring return	Palm operated (2)
<b>Catalog numbers</b>				
1 N.O. Reed contacts snap action 	<b>9007C84D</b> 	<b>9007C84E</b> 	<b>9007C84ED</b> 	<b>9007C84R (2)</b> 
1 N.C. Reed contacts snap action 	<b>9007C86D</b> 	<b>9007C86E</b> 	<b>9007C86ED</b> 	<b>9007C86R (2)</b> 
Weight, kg (lb)	0.568 (1.25)	0.568 (1.25)	0.568 (1.25)	0.568 (1.25)
Contact operation				
<b>Characteristics (nominal operating data)</b>				
Switch actuation	On end			
Type of actuation				
Pre-travel	2.5 mm (0.100")			
Total travel	6.3 mm (0.25")			
Differential	1.3 mm (0.05")			
Reverse overtravel	-			
Minimum force or torque 1 pole & 2 pole	4 lb (17.8 N)			
Terminal wire sizes (Cabling/Screw Clamp)	1 or 2, 12–22 AWG (2.05–0.644 mm <sup>2</sup> ) wires maximum			
Repeatability (linear travel of cam)	0.076 mm (± 0.003")			
Cable entry	1/2-14 NPT standard, optional M20 x 1.5 mm for ISO cable entry			

- To lock the nut in the desired position, crimp the slot near the bottom of the nut.
- Does not include mushroom button. Must be ordered separately from page 185.

Dimensions:  
pages 178 to 181







# Limit Switches

## 9007C Heavy Duty Industrial—Plug-in Body, Metal Standard Body—Reed Contacts

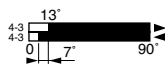
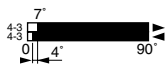
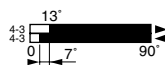
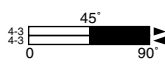
Type of head **Rotary (lever arm type) (1)**

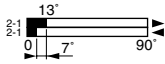
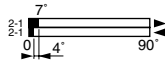
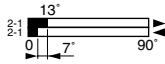
Standard plug-in body type

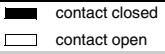

Type of operator	Standard pre-travel spring return	Low differential spring return	Light operating torque spring return	Maintained contact
Type of direction	CW & CCW (2)	CW & CCW (2)	CW & CCW (2)	CW (trip) CCW (reset)
Catalog numbers				
1 N.O. Reed contacts snap action 	<b>9007C84B2</b> 	<b>9007C84A2</b> 	<b>9007C84N2</b> 	<b>9007C84C</b> 
1 N.C. Reed contacts snap action 	<b>9007C86B2</b> 	<b>9007C86A2</b> 	<b>9007C86N2</b> 	<b>9007C86C</b> 
Weight, kg (lb)	0.568 (1.25)	0.568 (1.25)	0.568 (1.25)	0.568 (1.25)
Contact operation				
Characteristics (nominal operating data)				
Switch actuation	By 30° cam			
Type of actuation				
Pre-travel	13°	7°	13°	45°
Total travel	90°	90°	90°	90°
Differential	7°	4°	7°	—
Reverse overtravel	90°	90°	90°	—
Operating torque force 1 pole & 2 pole	4 lb-in (17.8 N•m)		25 oz-in (0.18 N•m)	3 lb-in (0.34 N•m)
Terminal wire sizes (Cabling/Screw Clamp)	1 or 2, 12–22 AWG (2.05–0.644 mm <sup>2</sup> ) wires maximum			
Repeatability (linear travel of cam)	0.15 mm (± 0.006")	0.076 mm (± 0.003")	0.15 mm (± 0.006")	0.15 mm (± 0.006")
Cable entry	1/2-14 NPT standard, optional M20 x 1.5 mm for ISO cable entry			

- Lever arm type must be ordered separately from pages 186 to 191.
- These devices are factory set to operate the contacts in **both** the CW and CCW directions. **Mode of operation** is field convertible to CW only or CCW only. **To order factory converted devices:** For CCW only operation, change the **2** at the end of the Type number to **1** (for example, C54B2 becomes C54B1). For CW only operation, delete the **2** at the end of the Type number (for example, C54B2 becomes C54B).



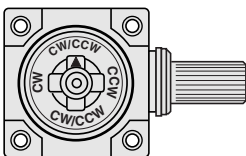









Mode of operation of the lever arm is easily convertible to clockwise or both. Simply pull out and rotate the arrow to the letters representing the desired direction—CW, CCW, or CW/CCW.

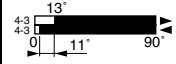
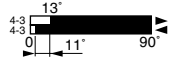
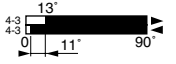
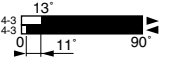
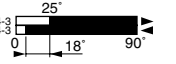

Dimensions:  
pages 178 to 181

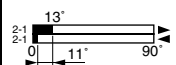
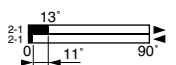
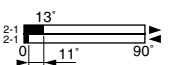
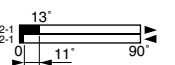
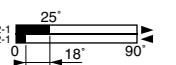
# Limit Switches

## 9007C Heavy Duty Industrial—Plug-in Body, Metal Standard Body—Reed Contacts

Type of head		Flexible operator (wobble stick)				
Standard plug-in body type						
Type of operator		Universal (1)	Wobble stick Delrin® extension (1)	Wobble stick wire extension (1)	Wobble stick coil spring extension (1)	Cat whisker
Catalog numbers						
1 N.O. Reed contacts snap action 		<b>9007C84JKC</b> 	<b>9007C84J</b> 	<b>9007C84K</b> 	<b>9007C84KC</b> 	<b>9007C84L</b> 
1 N.C. Reed contacts snap action 		<b>9007C86JKC</b> 	<b>9007C86J</b> 	<b>9007C86K</b> 	<b>9007C86KC</b> 	<b>9007C86L</b> 
Weight, kg (lb)		0.568 (1.25)	0.568 (1.25)	0.568 (1.25)	0.568 (1.25)	0.568 (1.25)
Contact operation		 contact closed  contact open				
Characteristics (nominal operating data)						
Switch actuation		By any moving object in any direction				
Type of actuation						
Pre-travel		13° (any direction)				25°
Total travel		90°				
Differential		11°				18°
Reverse overtravel		-				
Operating torque/force 1 pole & 2 pole		3 lb-in (0.34 N•m)				7 oz-in (0.05 N•m)
Terminal wire sizes (Cabling/Screw Clamp)		1 or 2, 12–22 AWG (2.05–0.644 mm <sup>2</sup> ) wires maximum				
Repeatability (linear travel of cam)		-				
Cable entry		1/2-14 NPT standard, optional M20 x 1.5 mm for ISO cable entry				

1. **Wobble stick extensions** are available separately for the universal head. See page 185.  
 Acceptable wire sizes: 12-22 AWG Recommended,  
 Terminal clamp torque: 7 lb-in (0.80 N•m).

Dimensions:  
 pages 178 to 181

# Limit Switches

## 9007C Heavy Duty Industrial—Plug-in Body, Metal Compact Body

Type of head **Side Plunger (mounting by the body)**

Compact plug-in body type



Type of operator	Side roller plunger spring return vertical roller (1)	Side push rod plunger spring return	Side push rod plunger adjustable (2) spring return	Side push rod plunger maintained contact
------------------	---	-------------------------------------	--	--

### Catalog numbers

1 N.O. 1 N.C. snap action	<b>9007C52F</b>	<b>9007C52G</b>	<b>9007C52GD</b>	<b>9007C52H</b>

Weight, kg (lb)	0.456 (1.01)	0.445 (0.98)	0.422 (0.93)	0.568 (1.25)
-----------------	--------------	--------------	--------------	--------------

Contact operation	 ■ contact closed □ contact open
-------------------	--

### Characteristics (nominal operating data)







Switch actuation	On end		
Type of actuation			
Pre-travel	2 mm (0.08")	3.6 mm (0.14")	
Pre-travel two Stage	First stage	2 mm (0.08")	–
	First stage to second stage	0.5 mm (0.02")	–
Total travel	6.3 mm (0.25")	6.3 mm (0.25")	
Differential	0.8 mm (0.03")	–	
Reverse overtravel	–	–	
Minimum force or torque 1 pole & 2 pole	4 lb (17.8 N)	7 lb (31.1 N)	
Terminal wire sizes (Cabling/Screw Clamp)	1 or 2, 12–22 AWG (2.05–0.644 mm <sup>2</sup> ) wires maximum		
Repeatability (linear travel of cam)	0.03 mm (0.001")	–	
Cable entry	1/2-14 NPT standard, optional M20 x 1.5 mm for ISO cable entry. Prewired options available.		

- Can be converted to horizontal roller type in the field. To order horizontal roller version add the letter **H** at the end of the equivalent vertical roller version type.
- To lock the nut in the desired position, crimp the slot near the bottom of the nut.

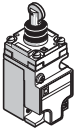
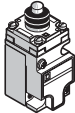
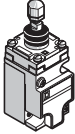
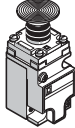
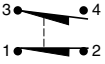
Dimensions:  
pages 178 to 181

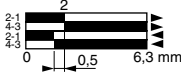
# Limit Switches

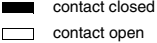
## 9007C Heavy Duty Industrial—Plug-in Body, Metal Compact Body

Type of head		Top Plunger (mounting by the body)			
Compact plug-in body type					
Type of operator		Top roller plunger spring return	Top push rod plunger spring return	Top push rod plunger adjustable (1) spring return	Palm operated (2)
<b>Catalog numbers</b>					
1 N.O. 1 N.C. snap action 		<b>9007C52D</b> 	<b>9007C52E</b> 	<b>9007C52ED</b> 	<b>9007C52R (2)</b> 
Weight, kg (lb)		0.169 (0.43)	0.169 (0.43)	0.422 (0.93)	0.568 (1.25)
Contact operation					
<b>Characteristics (nominal operating data)</b>					
Switch actuation		On end			
Type of actuation					
Pre-travel		2 mm (0.08")			
Pre-travel two Stage	First stage	2 mm (0.08")			
	First stage to second stage	0.03 mm (0.01")			
Total travel		6.3 mm (0.25")			
Differential		0.5 mm (0.02")			
Reverse overtravel					
Minimum force or torque	1 pole & 2 pole	3 lb (13.3 N)			
Terminal wire sizes (Cabling/Screw Clamp)		1 or 2, 12–22 AWG (2.05–0.644 mm <sup>2</sup> ) wires maximum			
Repeatability (linear travel of cam)		0.03 mm (0.001")			
Cable entry		1/2-14 NPT standard, optional M20 x 1.5 mm for ISO cable entry. Prewired options available.			

- To lock the nut in the desired position, crimp the slot near the bottom of the nut.
- Does not include mushroom button. Must be ordered separately see page 185.

Dimensions:  
pages 178 to 181

# Limit Switches

## 9007C Heavy Duty Industrial—Plug-in Body, Metal Compact Body

Type of head Rotary (lever arm type) (1)

Compact plug-in body type

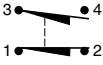
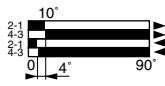
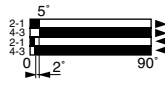
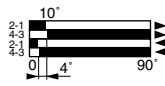
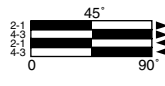
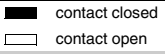
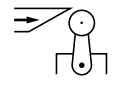

Type of operator	Standard pre-travel spring return	Low differential spring return	Light operating torque spring return	Maintained contact
Type of direction	CW & CCW (2)	CW & CCW (2)	CW & CCW (2)	CW (trip) CCW (reset)
<b>Catalog numbers</b>				
1 N.O. 1 N.C. snap action	<b>9007C52B2</b>	<b>9007C52A2</b>	<b>9007C52N2</b>	<b>9007C52C</b>
				
Weight, kg (lb)	0.481 (1.06)	0.481 (1.06)	0.481 (1.06)	0.481 (1.06)
Contact operation				
<b>Characteristics (nominal operating data)</b>				
Switch actuation	By 30° cam			
Type of actuation				
Pre-travel	10°	5°	10°	45°
Pre-travel two Stage				
First stage	10°	5°	10°	—
First stage to second stage	2,5°	1,5°	2,5°	—
Total travel	90°	90°	90°	90°
Differential	4°	2°	4°	—
Reverse overtravel	90°	90°	90°	—
Operating torque/force 1 pole & 2 pole	4 lb-in (0.45 N•m)		25 oz-in (0.18 N•m)	3 lb-in (0.34 N•m)
Terminal wire sizes (Cabling/Screw Clamp)	1 or 2, 12–22 AWG (2.05–0.644 mm <sup>2</sup> ) wires maximum			
Repeatability (linear travel of cam)	0.05 mm (± 0.002")	0.03 mm (± 0.001")	0.05 mm (± 0.002")	0.05 mm (± 0.002")
Cable entry	1/2-14 NPT standard, optional M20 x 1.5 mm for ISO cable entry			

- Lever arm type must be ordered separately from pages 186 to 191.
- These devices are factory set to operate the contacts in **both** the CW and CCW directions. **Mode of operation** is field convertible to CW only or CCW only.  
**To order factory converted devices:** For CCW only operation, change the 2 at the end of the Type number to 1 (for example, C52B2 becomes C52B1). For CW only operation, delete the 2 at the end of the Type number (for example, C52B2 becomes C52B).

Mode of operation of the lever arm is easily convertible to clockwise or both.  
Simply pull out and rotate the arrow to the letters representing the desired direction—CW, CCW, or CW/CCW.

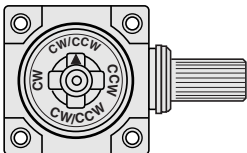

Dimensions:  
pages 178 to 181

# Limit Switches

## 9007C Heavy Duty Industrial—Plug-in Body, Metal Compact Body

Type of head **Flexible operator (wobble stick)**

Compact plug-in body type

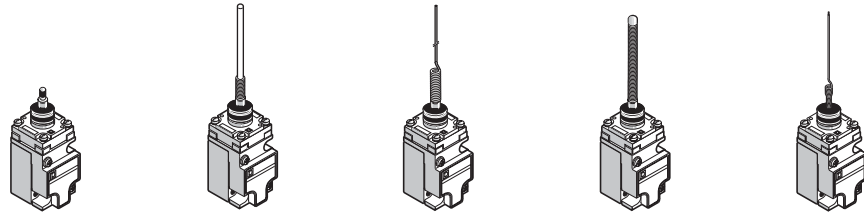

Type of operator	Universal (1)	Wobble stick Delrin® extension (1)	Wobble stick wire extension (1)	Wobble stick coil spring extension (1)	Cat whisker
Catalog numbers	9007C52JKC	9007C52J	9007C52K	9007C52KC	9007C52L
1 N.O. 1 N.C.					
Weight, kg (lb)	0.468 (1.03)	0.568 (1.25)	0.540 (1.19)	0.568 (1.25)	0.468 (1.03)
Contact operation					
<b>Characteristics (nominal operating data)</b>					
Switch actuation	By any moving				
Type of actuation					
Pre-travel	10° (any direction)				20°
Pre-travel two Stage					
First stage	10° (any direction)				20°
First stage to second stage	4°				5°
Total travel	90°				
Differential	3°				6°
Reverse overtravel	-				
Operating torque/force 1 pole & 2 pole	3 lb-in (0.34 N•m)				7 oz-in (0.05 N•m)
Terminal wire sizes (Cabling/Screw Clamp)	1 or 2, 12–22 AWG (2.05–0.644 mm <sup>2</sup> ) wires maximum				
Repeatability (linear travel of cam)	-				
Cable entry	1/2-14 NPT standard, optional M20 x 1.5 mm for ISO cable entry				

1. Wobble stick extensions are available separately for the universal head. See page 185.

# Limit Switches

## 9007C Heavy Duty Industrial—Plug-in Body, Metal

### Factory Modifications (Forms)



S9

Rotary head shown with S9 option

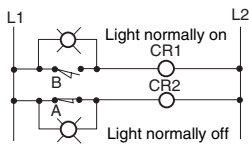

Form P5 Thru P9

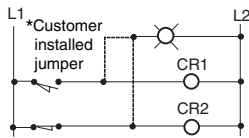

Form P10

\* Only one of the jumpers may be used.  
Pilot light is ON when load is energized

### Special features and modifications

Special features do not apply to 9007CR unless noted. Not field installable, except where noted.

#### Shaft equipped with hub for mounting larger diameter lever used with 9007T/FT limit switches

Any rotary lever arm 9007C, CF or CR switch can be furnished with an optional shaft and hub combination which will accept the lever arms normally used with 9007T and FT limit switches. To order, add S9 as suffix to the device number. For example, to order a 9007C54B2 with this modification, order as a 9007C54B2S9. For details about switches and lever arms that can be furnished with this modification, see the appropriate catalog or the Digest.

Description	Suffix to add to the device catalog number	Weight kg (lb)
Optional hub for 9007T/FT levers (not shown in this catalog)	S9	0.018 (0.04)
<b>Hub only: can be field installed on rotary shaft, see accessories page 177</b>		

#### Addition of LED pilot light (1)

Description	Suffix to add to the device catalog number	Weight kg (lb)
Addition of LED pilot light in parallel with N.O. contact (light normally on)	P5 (2)	0.57 (1.25)
Addition of LED pilot light in parallel with N.C. contact (light normally off)	P6 (2)	0.57 (1.25)
Addition of two LED pilot lights, one in parallel with N.O. contact (light normally on), one in parallel with N.C. contact (light normally off)	P7	0.57 (1.25)
Addition of two LED pilot lights in parallel with N.O. contacts (lights normally on)	P8 (3)	0.57 (1.25)
Addition of two LED pilot lights in parallel with N.C. contacts (lights normally off)	P9 (3)	0.57 (1.25)
Addition of one isolated LED pilot light (light on when load is energized)	P10 (4)	0.57 (1.25)

#### LED Pilot light, 24 to 120 V AC or DC on plug-in type switch (9007C52, C54, C62, C66, C68 or (2))

1. Bleeder circuit must be added to ensure PLC compatibility.
2. 9007C84 and C86 are available with P5 or P6 pilot lights only.
3. 9007C62, C66 or C68 only.
4. 9007C54 only. Not available with prewired receptacles.

#### Examples of complete units with pilot lights in standard plug-in body type

Single pole		
Side plunger	9007C54FP6	0.57 (1.25)
Top plunger	9007C54DP6	0.57 (1.25)
	9007C54EP6	0.57 (1.25)
Rotary	9007C54B2P6	0.57 (1.25)
Wobble stick	9007C54LP6	0.57 (1.25)
	9007C54JP6	0.57 (1.25)
Two poles		
Side plunger	9007C62FP6	0.57 (1.25)
Top plunger	9007C62DP6	0.57 (1.25)
	9007C62EP6	0.57 (1.25)
Rotary	9007C62B2P6	0.57 (1.25)
Wobble stick	9007C62LP6	0.57 (1.25)
	9007C62JP6	0.57 (1.25)



# Limit Switches

## 9007C Heavy Duty Industrial—Plug-in Body, Metal

### Factory Modifications (Forms)

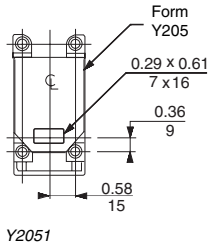

#### Special features and modifications (continued)

Special features do not apply to 9007CR unless noted. Not field installable, except where noted.

#### Manifold mounting

Description	Suffix to add to the device catalog number	Weight kg (lb)
<b>Manifold mounting</b> available on standard and compact types. Replaces existing type B installations if new hole is drilled to match knockout. Supersedes type C with form Y205. Receptacle is furnished with a wiring hole and a gasket in the base.	Y2051	0.57 (1.25)
<b>Special chemical resistant coating</b> (includes Viton® fluorocarbon seals—Y140, and stainless steel head and body screws) (1)	L3	0.57 (1.25)
<b>Low temperature – lever types only:</b> limit switch will operate in an ambient temperature range of -40 to 185 °F (standard limit switch ambient temperature range is -20 to 185 °F). Minimum temperature is based on the absence of freezing moisture or water.	Y128	0.57 (1.25)
<b>Viton fluorocarbon gaskets and seals</b> (1) Substitution of Viton fluorocarbon gaskets and seals on:		
Lever arm type, standard box (Viton fluorocarbon shaft seals on lever arm types as standard)	Y140	0.57 (1.25)
Lever arm type, compact box (Viton fluorocarbon shaft seals on lever arm types as standard)	Y140	0.57 (1.25)
Plunger type, standard box	Y140	0.57 (1.25)
Plunger type, compact box	Y140	0.57 (1.25)
Substitution of Viton fluorocarbon boot only on plunger type switches	Y1401	0.57 (1.25)

1. Fluorocarbon (as found in Viton seals) has been shown to resist sunlight aging problems.

#### Mini and micro connectors, ISO M20 (Form M11)

To order 9007C with ISO M 20 thread add the suffix **M11** to the device number.

#### Examples of complete unit catalog numbers with ISO M20 thread in standard plug-in body type

Type of head	Catalog number	Weight kg (lb)
<b>Single pole</b>		
Side plunger	9007C54FM11	0.57 (1.25)
Top plunger	9007C54DM11	0.57 (1.25)
	9007C54EM11	0.57 (1.25)
<b>Rotary</b>	9007C54B2M11	0.57 (1.25)
<b>Wobble stick</b>	9007C54LM11	0.57 (1.25)
	9007C54JM11	0.57 (1.25)
<b>Two poles</b>		
Side plunger	9007C62FM11	0.57 (1.25)
Top plunger	9007C62DM11	0.57 (1.25)
	9007C62EM11	0.57 (1.25)
<b>Rotary</b>	9007C62B2M11	0.57 (1.25)
<b>Wobble stick</b>	9007C62LM11	0.57 (1.25)
	9007C62JM11	0.57 (1.25)

# Limit Switches

## 9007C Heavy Duty Industrial—Plug-in Body, Metal

### Factory Modifications (Forms)



Y190\*

Standard body shown with Y190\* option

#### Special features and modifications (continued)

Special features do not apply to 9007CR unless noted. Not field installable, except where noted.

#### Pre-wired receptacle (1) (2)

Description	For use	Suffix to add to the device catalog number	Weight kg (lb)
<b>Plug-in limit switch furnished with pre-wired mini 5-pin Brad Harrison male connector</b>			
Single pole	For use with Brad Harrison female portable plug No.41306, 41307 or 41308 (or equal).	Y1901	0.60 (1.33)
	Same as Y1901 but with different wire color coding	Y1905	0.60 (1.33)
<b>Tamper proof screws in complete switch only</b>			
Single pole	Same as Y1901 but with tamper proof screws on head and body	Y1903	0.60 (1.33)
	Similar to Y1905 except for double pole device	Y19013	0.60 (1.33)

1. Plug and cable assemblies: see accessories page 177
2. Not available with P10 or for Hazardous location switches

#### Examples of complete unit catalog numbers with mini or micro connectors in standard plug-in body type

Type of head	Catalog number	Weight kg (lb)
<b>Single pole, 5-pin mini connector (7/8"-16 UN-2A thread)</b>		
Side plunger	9007C54FY1901	0.57 (1.25)
	9007C54DY1901	0.57 (1.25)
Top plunger	9007C54EY1901	0.57 (1.25)
	9007C54BY1901	0.57 (1.25)
Rotary	9007C54LY1901	0.57 (1.25)
Wobble stick	9007C54JY1901	0.57 (1.25)
	9007C54LY1901	0.57 (1.25)
<b>Two poles, 9-pin mini connector (1-2/8"-16 UN-2A thread)</b>		
Side plunger	9007C62FY19016	0.57 (1.25)
	9007C62DY19016	0.57 (1.25)
Top plunger	9007C62EY19016	0.57 (1.25)
	9007C62BY19016	0.57 (1.25)
Rotary	9007C62LY19016	0.57 (1.25)
Wobble stick	9007C62JY19016	0.57 (1.25)
	9007C62LY19016	0.57 (1.25)
<b>Single pole, 5-pin micro single key (M12 x 1 thread)</b>		
Side plunger	9007C62FY1912	0.57 (1.25)
	9007C54DY1912	0.57 (1.25)
Top plunger	9007C54EY1912	0.57 (1.25)
	9007C54BY1912	0.57 (1.25)
Rotary	9007C54LY1912	0.57 (1.25)
Wobble stick	9007C54JY1912	0.57 (1.25)
	9007C54LY1912	0.57 (1.25)
<b>Single pole, 5-pin micro connector two keys (1/2"-20 UNF-2A thread)</b>		
Side plunger	9007C54FY19019	0.57 (1.25)
	9007C54DY19019	0.57 (1.25)
Top plunger	9007C54EY19019	0.57 (1.25)
	9007C54BY19019	0.57 (1.25)
Rotary	9007C54LY19019	0.57 (1.25)
Wobble stick	9007C54JY19019	0.57 (1.25)
	9007C54LY19019	0.57 (1.25)

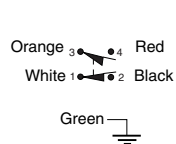

Form Y1901, Y1903

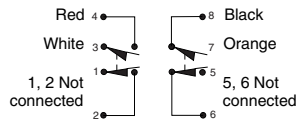

Form Y19013



Form Y1905

# Limit Switches

## 9007C Heavy Duty Industrial—Plug-in Body, Metal

### Factory Modifications (Forms)



Y18\*\*  
Terminal base shown  
with Y18\*\* option

#### Special features and modifications (continued)

Special features do not apply to 9007CR unless noted. Not field installable, except where noted.

#### Potted limit (position) switch or plug-in receptacle only (1)

Description (2)	Suffix to add to the device catalog number	Weight kg (lb)
<b>With individual wires</b>		
Single pole	With five #16 wires five feet long	Y1841 0.59 (1.30)
Two pole	With nine #16 wires five feet long	Y1842 0.60 (1.32)
<b>With STOWA cord</b>		
Single pole	With five conductor #16 STOWA cord eight feet long	Y1851 1.30 (2.88)
Single pole	Same as Y1851 but with different wire color coding	Y1855 1.30 (2.88)
Two pole	With nine conductor #16 STOWA cord eight feet long	Y1852 1.31 (2.90)
Two pole	Same as Y1852 but with different wire color coding	Y1856 1.31 (2.90)

#### Tamper proof Screws—Complete Switch Only

<b>With individual wires</b>		
Same as Y1841 but with tamper proof screws on head and body	Y1843	0.59 (1.30)
Same as Y1842 but with tamper proof screws on head and body	Y1844	0.60 (1.32)
<b>With STOWA cord</b>		
Same as Y1851 but with tamper proof screws on head and body	Y1853	1.30 (2.88)
Same as Y1852 but with tamper proof screws on head and body	Y1854	1.30 (2.88)
Same as Y1855 but with tamper proof screws on head and body	Y1857	1.31 (2.90)
Same as Y1856 but with tamper proof screws on head and body	Y1858	1.31 (2.90)

- Not for 9007CR Hazardous location devices
- Wire entry completely sealed with epoxy resin.

#### Dust boot (protects against abrasive dusts, dirt, grit and sand)

Description	Suffix to add to the device catalog number	Weight kg (lb)
Lever type limit switch furnished with a boot around the shaft	On all 9007C and 9007CR lever type switches	Y33 0.01 (0.01)
Dust boot only	see accessories, page 177	

#### Wiring Diagrams

##### Forms Y1851 and Y1853

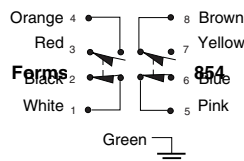
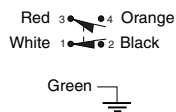

##### Forms Y1855 and Y1857

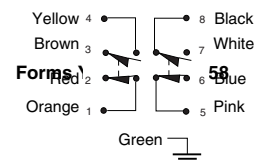
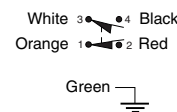

# Limit Switches

## 9007C Heavy Duty Industrial—Plug-in Body, Metal

### Factory Modifications (Forms)

#### Special features and modifications (continued)

Special features do not apply to 9007CR unless noted. Not field installable, except where noted.

Optional shafts		
Description	Suffix to add to the device catalog number	Weight kg (lb)
<b>Optional shaft (7.8 mm (0.306") diameter):</b> To accommodate lever arms from the obsolete Denison C limit switches. Available on all 9007C, CF, or CR limit switches	Y247	0.57 (1.25)
<b>Optional shaft (7.1 mm (0.28") diameter):</b> Available on all 9007C, CF, or CR limit switches	Y249	0.57 (1.25)

Switch with adapter plate		
Description	Suffix to add to the device catalog number	Weight kg (lb)
<b>Switch with adapter plate permitting substitution of any 9007C switch with standard body for any type T switch with style B base plate</b>	Y147	–

#### Direct acting contacts / Positive opening contacts ☺ Y1561

One pole, normally closed, slow make-slow break, direct acting contact mechanism substituted for standard snap switch on 9007C52, C54 and CR53 devices.

This mechanism was designed for use in emergency overtravel applications. The movable contact of this basic switch unit is acted upon directly by the actuating mechanism of the limit switch and is not dependent upon the force exerted by a snap switch blade or spring to open the circuit. Because these contacts are slow make-slow break, they are best suited for applications where they are not actuated during normal operation, but only if abnormal overtravel is encountered.

#### Electrical contact ratings

AC—NEMA A600 maximum current—35 % power factor						DC maximum current			
Volts	Make		Break		Continuous carrying	Volts	Make or break		Continuous carrying
	A	VA	A	VA	A		A	VA	A
120	60	7200	6	720	10	125	1.1/0.55 (1)	138/69 (1)	5/2.5 (1)
240	30	7200	3	720	10	–	–	–	–
480	15	7200	1.5	720	10	250	0.27	67.5	2.5
600	12	7200	1.2	720	10	600	0.10	60	2.5

1. 9007C52 compact unit ratings at 125 Vdc—same ratings as 9007C54 and 9007CR53 at other voltages.

Description	Suffix to add to the device catalog number	Weight kg (lb)
<b>Direct acting contact/positive opening contact block (slow break single pole only)</b>	Y1561	0.566 (1.25)

# Limit Switches

## 9007C Heavy Duty Industrial—Plug-in Body, Metal Accessories

Accessories		
<b>Hub only</b>		
Description	Catalog number	Weight kg (lb)
Hub can be field installed on any 9007C lever type switch, increasing the shaft diameter from 0.375" (9.53 mm) to 0.749" (19 mm), to accept levers normally used with 9007T/FT switches.	9007S9	0.02 (0.04)
<b>Dust boot only</b>		
Description	Catalog number	Weight kg (lb)
Dust boot can be field installed on any 9007C and CR lever type switch	9007BT3	0.01 (0.01)
<b>Conduit seal insert (field instable)</b>		
Description	Catalog number	Weight kg (lb)
Conduit seal fits in conduit entrance and excludes liquids		
5 hole seal	31032-488-01	0.01 (0.02)
9 hole seal	31032-815-01	0.01 (0.02)
<b>Plug and cable assemblies</b>		
Description	Catalog number	Weight kg (lb)
<b>5-pin mini connecting cables (to fit certain switches with Form Y190**)</b>		
Plug and 3 ft (0.91 m) cable	BH20-5-3	—
Plug and 6 ft (1.83 m) cable	BH20-5-6	—
Plug and 12 ft (3.66 m) cable	BH20-5-12	—
Note: Other cables available. See the Machine Cabling section of the Sensors catalog, 9006CT0101.		
<b>Adapter—Field installable</b>		
Description	Catalog number	Weight kg (lb)
<b>Adapter plate kit only</b> Plate plus mounting screws for substitution of any 9007C switch with standard box for any 9007T switch with style B base plate	9007BT1	0.23 (0.50)
<b>Adapter plate</b> to allow direct substitution of any 9007C plunger switches for 9007B plug-in plunger switches— <b>use only</b> if there is a problem in lining up cam tracks		
Standard body type	9007CT10 (1)	0.13 (0.28)
Compact body type	9007CT13 (2)	0.01 (0.20)
<b>Adapter plate kit</b> permitting direct substitution of any 9007C lever arm switch with standard box for any 9007AW lever arm switch	9007CT11	0.23 (0.50)
<b>20 mm conduit connection adapter</b> male 0.5" (12.7 mm) NPT on one end, female 0.787" (20 mm) on other end	9007CT12	0.01 (0.20)

(1) Dimensions: 0.22" (5.6 mm) x 2.94" (75 mm) x 1.54" (39 mm)

(2) Dimensions: 0.22" (5.6 mm) x 2.07" (53 mm) x 1.54" (39 mm)

# Limit Switches

## 9007C Heavy Duty Industrial—Plug-in Body, Metal

### Dimensions—Standard Body

#### Side Plunger

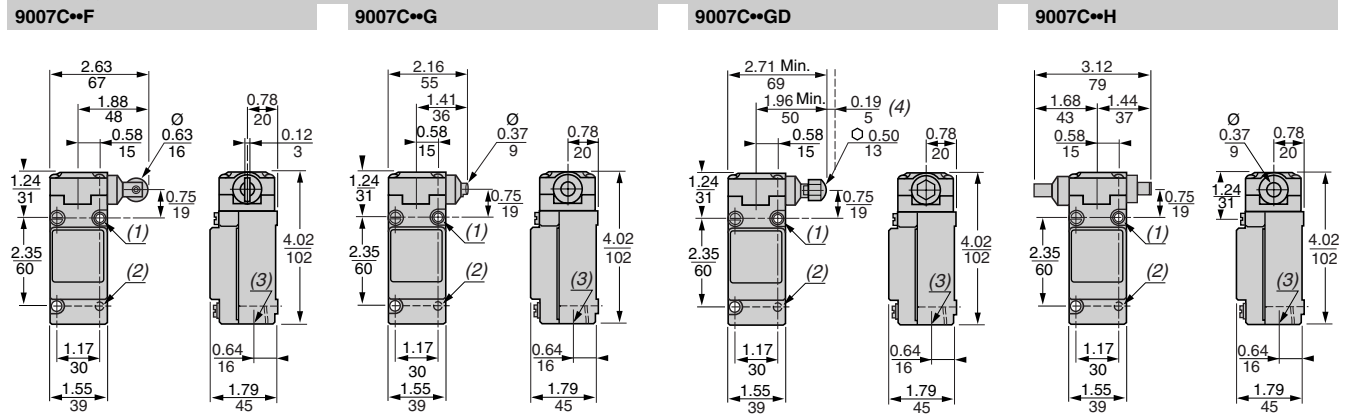

Dual dimensions:  $\frac{\text{in.}}{\text{mm}}$

1. 2 x 0.20/5 x 0.22/6 HLS.
2. 2 x 10-24 Tapped HLS Back Mtg 0.29/7 DP.
3. 1/2 14 NPT.
4. Adjustable.

#### Top Plunger

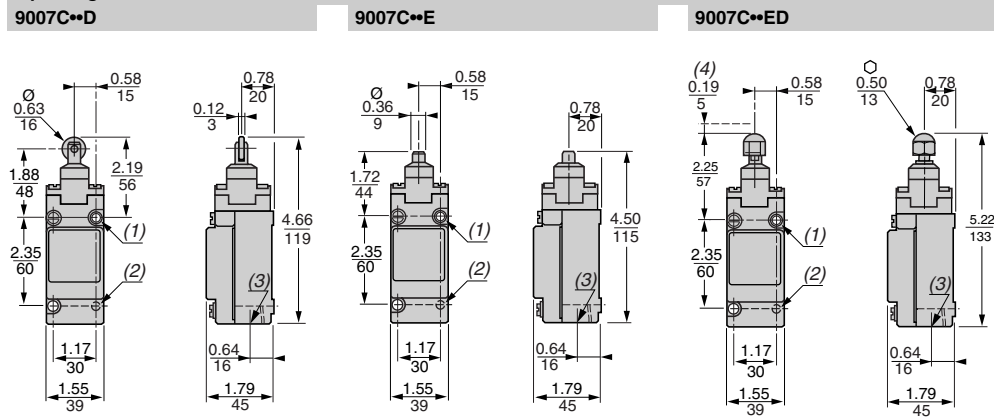

Dual dimensions:  $\frac{\text{in.}}{\text{mm}}$

1. 2 x 0.20/5 x 0.22/6 HLS.
2. 2 x 10-24 Tapped HLS Back Mtg 0.29/7 DP.
3. 1/2 14 NPT.
4. Adjustable.

# Limit Switches

## 9007C Heavy Duty Industrial—Plug-in Body, Metal Dimensions—Standard Body

Rotary  
9007C\*\*\* A, B, C, N, T5, T10

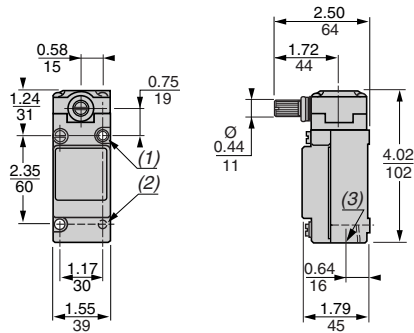

Dual dimensions:  $\frac{\text{in.}}{\text{mm}}$

1. 2 x 0.20/5 x 0.22/6 HLS.
2. 2 x 10-24 Tapped HLS Back Mtg 0.29/7 DP.
- (3) 1/2 14 NPT.

Wobble stick  
9007C\*\*JKC

9007C\*\*J

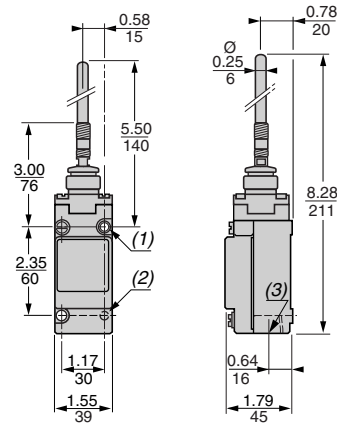
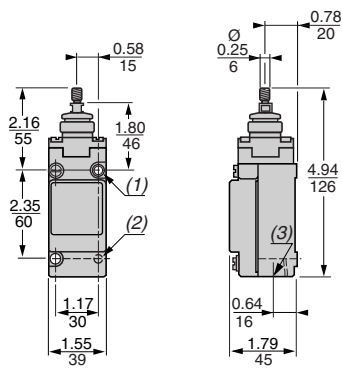

9007C\*\*K

9007C\*\*KC

9007C\*\*L

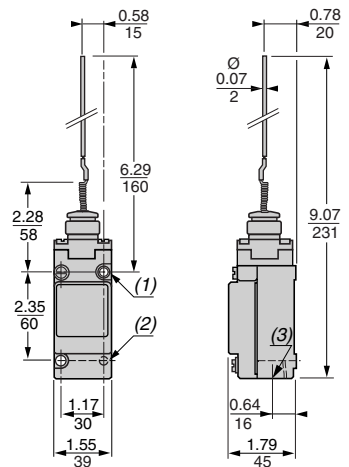
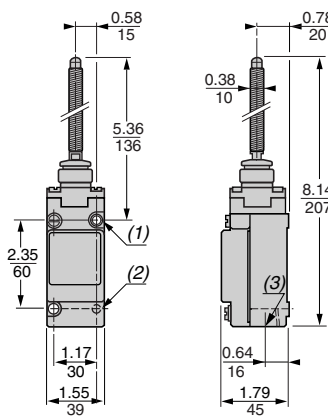
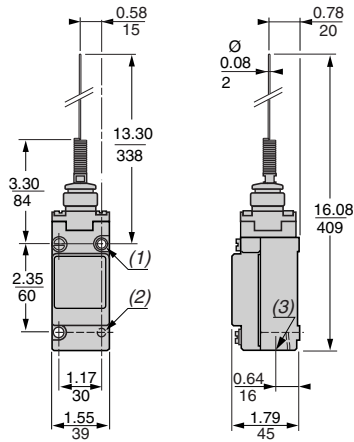

Dual dimensions:  $\frac{\text{in.}}{\text{mm}}$

1. 2 x 0.20/5 x 0.22/6 HLS.
2. 2 x 10-24 Tapped HLS Back Mtg 0.29/7 DP.
3. 1/2 14 NPT.

Limit Switches

# Limit Switches

## 9007C Heavy Duty Industrial—Plug-in Body, Metal

### Dimensions—Compact Body

#### Side Plunger

##### 9007C52F

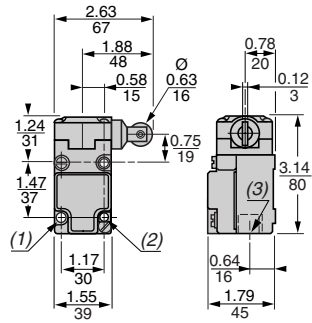

##### 9007C52G

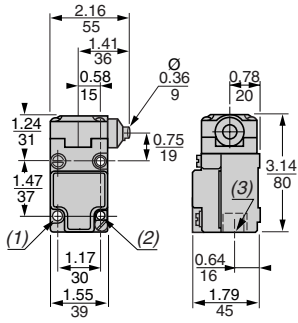

##### 9007C52GD

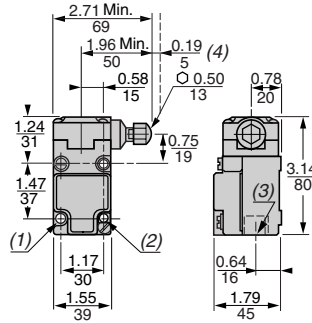

##### 9007C52H

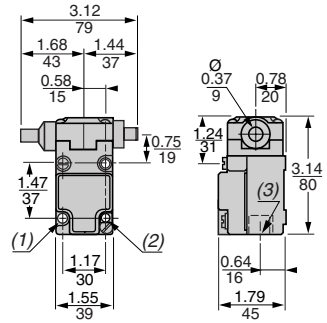

Dual dimensions:  $\frac{\text{in.}}{\text{mm}}$

1. 2 x 0.20/5 HLS.
2. 2 x 10-24 Tapped HLS Back Mtg 0.20/5 DP.
3. 1/2 14 NPT.
4. Adjustable.

#### Top Plunger

##### 9007C52D

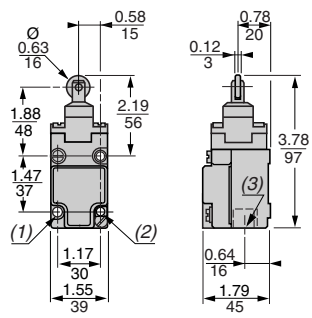

##### 9007C52E

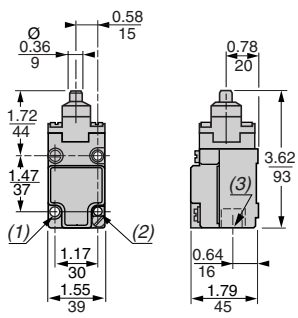

##### 9007C52ED

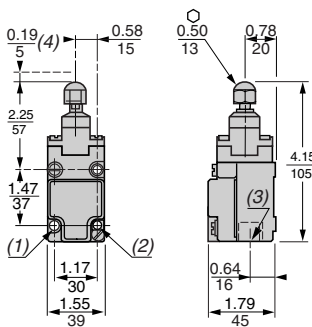

Dual dimensions:  $\frac{\text{in.}}{\text{mm}}$

1. 2 x 0.20/5 HLS.
2. 2 x 10-24 Tapped HLS Back Mtg 0.20/5 DP.
3. 1/2 14 NPT.
4. Adjustable.



# Limit Switches

## 9007C Heavy Duty Industrial—Plug-in Body, Metal Dimensions—Compact Body

### Rotary

9007C52\*\* A, B, C, N, T5, T10

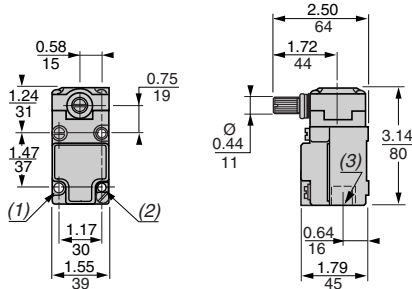

Dual dimensions:  $\frac{\text{in.}}{\text{mm}}$

1. 2 x 0.20/5 x 0.22/6 HLS.
2. 2 x 10-24 Tapped HLS Back Mtg 0.29/7 DP.
- (4) 1/2 14 NPT.

### Wobble stick

9007C52JKC

### 9007C52J

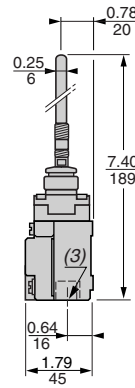
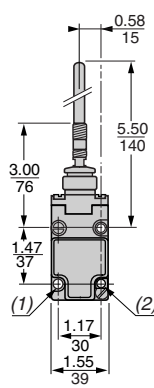
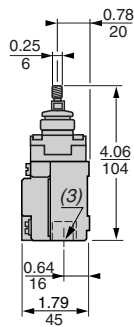
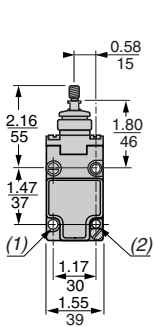

### 9007C52K

### 9007C52KC

### 9007C52L

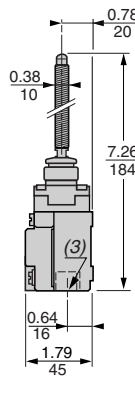
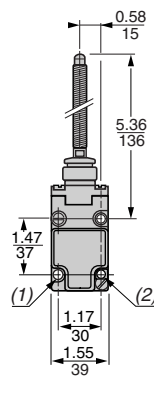
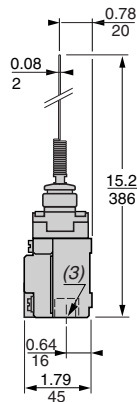
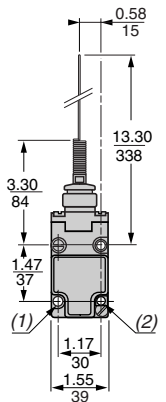

Dual dimensions:  $\frac{\text{in.}}{\text{mm}}$

1. 2 x 0.20/5 x 0.22/6 HLS.
2. 2 x 10-24 Tapped HLS Back Mtg 0.29/7 DP.
3. 1/2 14 NPT.

Limit Switches

# Limit Switches

## 9007C Heavy Duty Industrial—Plug-in Body, Metal Adaptable Sub-Assemblies

Limit Switches

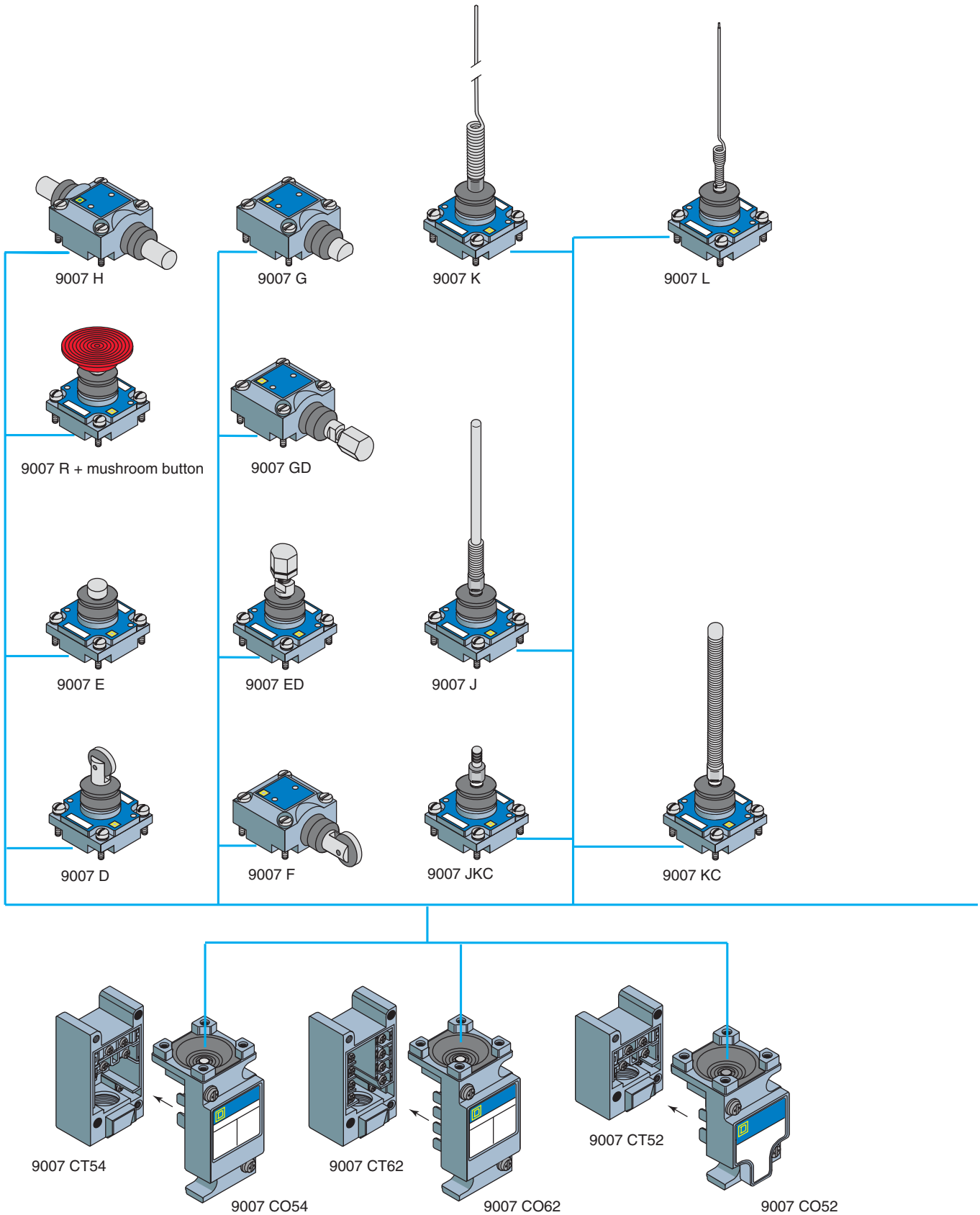

**Limit Switches**  
**9007C Heavy Duty Industrial—Plug-in Body, Metal**  
**Adaptable Sub-Assemblies**

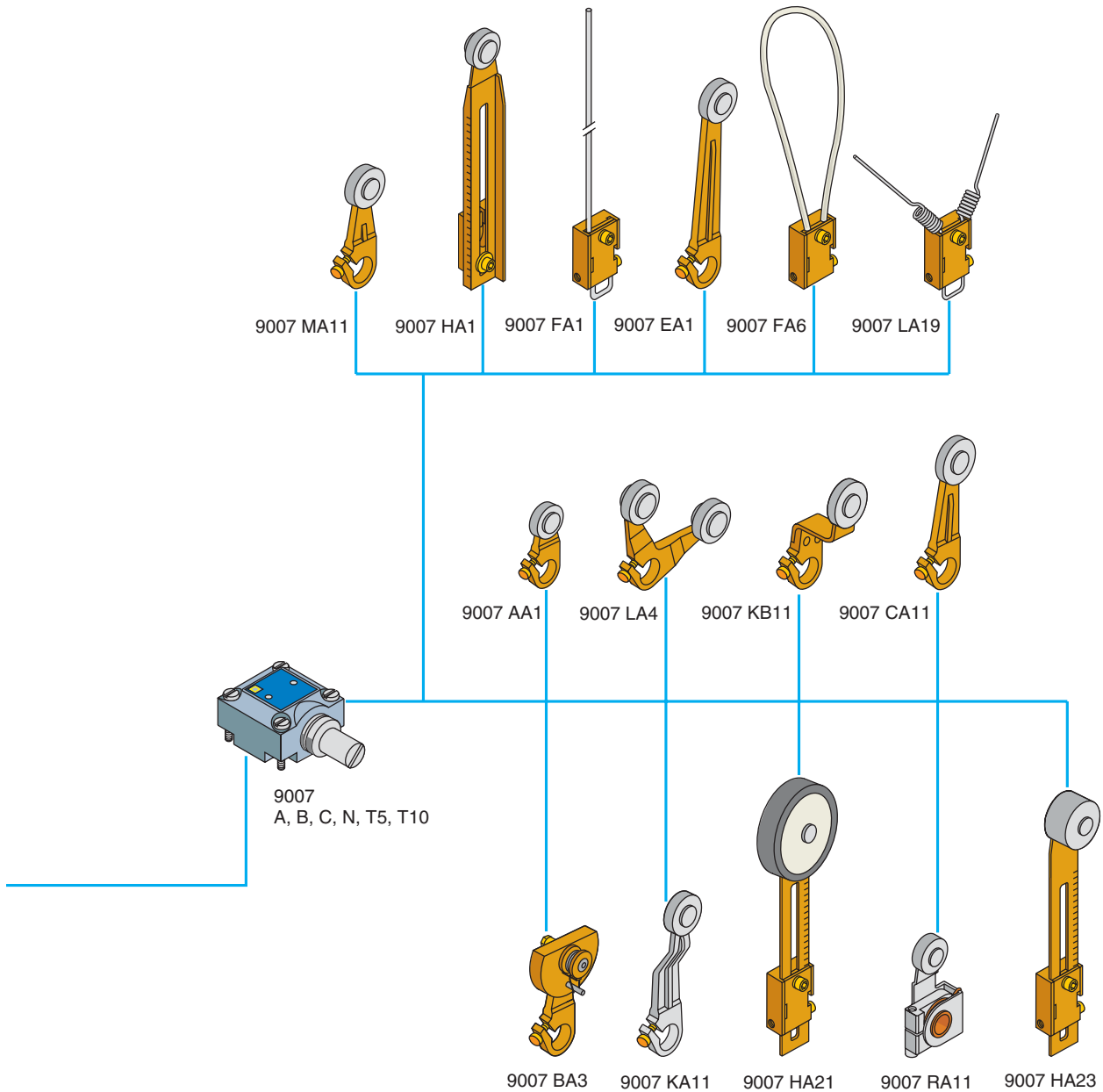

# Limit Switches

## 9007C Heavy Duty Industrial—Plug-in Body, Metal Adaptable Sub-Assemblies

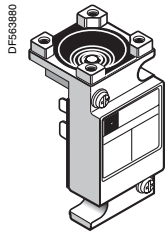

9007CO54

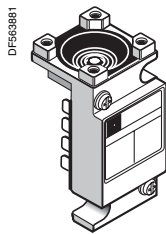

9007CO62

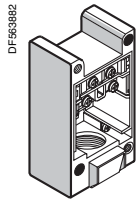

9007CT54

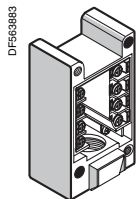

9007CT62

Limit Switches

### Body with contacts for plunger or rotary heads Plug-in Unit (Top) with contacts

Type	Type of contact	Function diagram	Catalog number	Weight kg (lb)
For standard plug-in body type	Single pole		9007CO54	0.19 (0.42)
	Two pole		9007CO62	0.20 (0.44)
	Two stage		9007CO66	0.23 (0.50)
	Neutral position		9007CO68	0.20 (0.45)
For compact plug-in body type	Single pole		9007CO52	0.18 (0.40)

### Plug-in Receptacle (Base) with screw terminals (1)

Type	Type of contact	Function diagram	Catalog number	Weight kg (lb)
For standard plug-in body type	Single pole		9007CT54	0.22 (0.48)
	Two pole		9007CT62	0.22 (0.48)
	Neutral position		9007CT62	0.22 (0.48)
	Two stage		9007CT62	0.22 (0.48)
	Reed switches, either N/O or N/C (2)		9007CT54	0.22 (0.48)
For compact plug-in body type	Single pole		9007CT52	0.15 (0.34)

1. Acceptable wire sizes: 12-22 AWG (2.05 mm<sup>2</sup>-0.644mm<sup>2</sup>). Recommended terminal clamp torque: 7 lb-in (0.80 N•m).
2. Reed switches: plug-in switches less heads are not available as separate units. Order complete plug-in unit with a head. Example: 9007C084B2.

Dimensions:  
page 192

# Limit Switches

## 9007C Heavy Duty Industrial—Plug-in Body, Metal

### Adaptable Sub-Assemblies

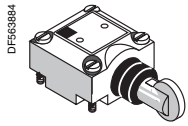

9007F

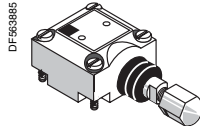

9007GD

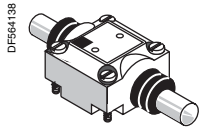

9007H

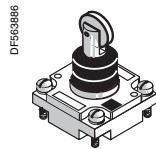

9007D

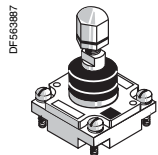

9007ED

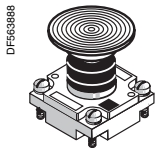

9007R + mushroom button

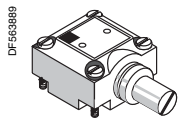

9007C

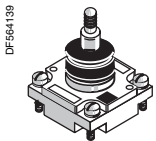

9007JKC

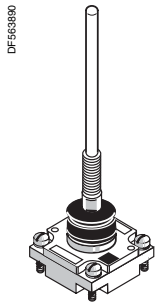

9007J

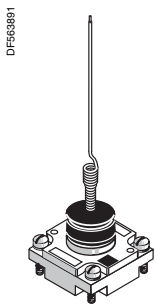

9007L

#### Heads for linear, rotary and multi-directional movements

##### Side plunger heads

Type of operator	Catalog number	Weight kg (lb)
Side roller plunger, spring return, vertical roller (1)	9007F	0.16 (0.36)
Side push rod plunger, spring return	9007G	0.15 (0.34)
Side push rod plunger, adjustable spring return	9007GD	0.16 (0.36)
Side push rod plunger, maintained contact	9007H	0.16 (0.36)

##### Top plunger heads

Type of operator	Catalog number	Weight kg (lb)
Top roller plunger, spring return	9007D	0.12 (0.26)
Top push rod plunger, spring return	9007E	0.11 (0.24)
Top push rod plunger, adjustable spring return	9007ED	0.12 (0.27)
Palm operated turret head without mushroom button Mushroom button see Accessories (below)	9007R	0.13 (0.28)

##### Rotary heads (without lever arm type)

Type of operator	Type of direction	Catalog number	Weight kg (lb)
Standard pre-travel spring return	CW & CCW	9007B	0.19 (0.41)
Low differential spring return	CW & CCW	9007A	0.19 (0.41)
Neutral position Standard pre-travel spring return	CW & CCW	9007T10	0.16 (0.36)
Neutral position Low differential spring return	CW & CCW	9007T5	0.16 (0.36)
Extra light operating torque spring return	CW & CCW	9007N	0.18 (0.40)
Maintained contact	CW (trip) CCW (reset)	9007C	0.19 (0.41)

##### Multi-directional head

Type of operator	Catalog number	Weight kg (lb)
Universal (2)	9007JKC	0.19 (0.41)
Wobble stick, Delrin® extension (2)	9007J	0.20 (0.43)
Wobble stick, wire extension (2)	9007K	0.26 (0.57)
Wobble stick, coil spring extension (2)	9007KC	0.22 (0.48)
Cat whisker	9007L	0.17 (0.37)

##### Accessories

Description	Diameter in. (mm)	Color	Catalog number	Weight kg (lb)
Mushroom button for palm operated turret head	1.38 (35)	Black	2358C6G3	0.03 (0.06)
		Red	2358C6G2	0.03 (0.06)
		Green	2358C6G6	0.03 (0.06)
		Yellow	2358C6G8	0.03 (0.06)
	2.25 (57.2)	Black	—	—
		Red	2358C22G3	0.05 (0.10)
		Green	2358C22G6	0.05 (0.10)
		Yellow	2358C22G8	0.05 (0.10)
Description (2)	Type of extension	Catalog number	Weight kg (lb)	
Wobble stick extensions for the universal head	Delrin® extension	9007WJ	0.01 (0.03)	
	Wire extension	9007WK	0.01 (0.02)	
	Coil spring extension	9007WKC	0.02 (0.04)	

- Field convertible to horizontal.
- Acceptable wire sizes: 12-22 AWG (2.05 mm<sup>2</sup>-0.644mm<sup>2</sup>).  
Recommended terminal clamp torque: 7 lb-in (0.80 N\*m).

# Limit Switches

## 9007C Heavy Duty Industrial—Plug-in Body, Metal

### Lever Arms for Rotary Heads

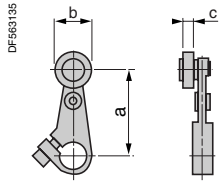

a: Length of lever Arm  
b: Roller diameter  
c: Roller width



9007AA1



9007MA11

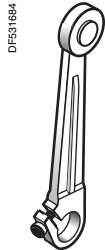

9007EA1

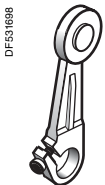

9007CA11

#### Cast zinc lever arms with standard roller

##### Lever arms with steel roller (1)

Arm	Steel roller		Catalog number	Weight kg (lb)
	Length (a) in. (mm)	Diameter (b) in. (mm)		
0.88 (22)		0.25 (6.3)	9007AA1	0.02 (0.05)
		0.63 (16)	9007AA2	0.03 (0.07)
1.38 (35)	0.75 (19)	0.25 (6.3)	9007BA11	0.03 (0.07)
		0.63 (16)	9007BA12	0.05 (0.10)
	0.63 (16)	0.25 (6.3)	9007BA1	0.03 (0.07)
		0.63 (16)	9007BA2	0.04 (0.08)
1.5 (38)	0.75 (19)	0.25 (6.3)	9007MA11	0.03 (0.07)
		0.63 (16)	9007MA12	0.05 (0.11)
	0.63 (16)	0.25 (6.3)	9007MA1	0.03 (0.06)
		0.63 (16)	9007MA2	0.05 (0.10)
2 (51)	0.75 (19)	0.25 (6.3)	9007CA11	0.04 (0.08)
		0.63 (16)	9007CA12	0.05 (0.12)
	0.63 (16)	0.25 (6.3)	9007CA1	0.04 (0.08)
		0.63 (16)	9007CA2	0.05 (0.10)
2.5 (63.5)	0.75 (19)	0.25 (6.3)	9007DA11	0.05 (0.10)
		0.63 (16)	9007DA12	0.06 (0.13)
	0.63 (16)	0.25 (6.3)	9007DA1	0.04 (0.08)
		0.63 (16)	9007DA2	0.05 (0.11)
3 (76)	0.75 (19)	0.25 (6.3)	9007EA11	0.05 (0.10)
		0.63 (16)	9007EA12	0.06 (0.14)
	0.63 (16)	0.25 (6.3)	9007EA1	0.04 (0.09)
		0.63 (16)	9007EA2	0.06 (0.14)

##### Lever arms with nylon roller

Arm	Nylon roller		Catalog number	Weight kg (lb)
	Length (a) in. (mm)	Diameter (b) in. (mm)		
0.88 (22)		0.25 (6.3)	9007AA8	0.02 (0.05)
		0.63 (16)	9007AA17	0.03 (0.07)
1.38 (35)	0.75 (19)	0.25 (6.3)	9007BA18	0.03 (0.07)
		0.63 (16)	9007BA8	0.05 (0.10)
	0.63 (16)	0.25 (6.3)	9007BA17	0.05 (0.11)
		0.63 (16)	9007BA4	0.03 (0.06)
		0.63 (16)	9007BA13	0.05 (0.10)
		0.63 (16)	9007BA18	0.03 (0.06)
1.5 (38)	0.75 (19)	0.25 (6.3)	9007MA8	0.05 (0.10)
		0.63 (16)	9007MA17	0.05 (0.10)
	1 (25.4)	0.25 (6.3)	9007MA4	0.05 (0.10)
		0.63 (16)	9007MA13	0.05 (0.12)
2 (51)	0.75 (19)	0.25 (6.3)	9007CA18	0.05 (0.10)
		0.63 (16)	9007CA8	0.03 (0.06)
	0.63 (16)	0.25 (6.3)	9007CA17	0.03 (0.07)
		0.63 (16)	9007CA4	0.05 (0.12)
2.5 (63.5)	1 (25.4)	0.25 (6.3)	9007CA13	0.06 (0.14)
		0.63 (16)	9007CA18	0.03 (0.07)
	0.75 (19)	0.25 (6.3)	9007DA8	0.06 (0.13)
		0.63 (16)	9007DA17	0.06 (0.13)
3 (76)	1 (25.4)	0.25 (6.3)	9007DA4	0.06 (0.14)
		0.63 (16)	9007DA13	0.07 (0.15)
	0.75 (19)	0.25 (6.3)	9007EA18	0.04 (0.08)
		0.63 (16)	9007EA8	0.06 (0.14)
0.63 (16)	0.25 (6.3)	9007EA17	0.07 (0.16)	
	0.63 (16)	9007EA4	0.07 (0.15)	
1 (25.4)	0.25 (6.3)	9007EA13	0.08 (0.17)	
	0.63 (16)	9007EA13	0.08 (0.17)	

1. Material is hardened, oil-impregnated, sintered iron.

Dimensions:  
page 193

# Limit Switches

## 9007C Heavy Duty Industrial—Plug-in Body, Metal

### Lever Arms for Rotary Heads

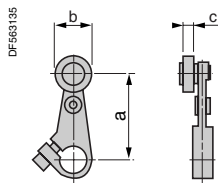

a: Length of lever Arm  
b: Roller diameter  
c: Roller width

#### Cast zinc lever arms (continued)

##### Lever arms with ball bearing roller

Arm	Ball bearing roller		Catalog number	Weight kg (lb)
Length (a) in. (mm)	Diameter (b) in. (mm)	Width (c) in. (mm)		
0.88 (22)	0.69 (17.5)	0.25 (6.3)	9007AA9	0.04 (0.09)
1.38 (35)	0.69 (17.5)	0.25 (6.3)	9007BA9	0.04 (0.09)
1.5 (38)	0.69 (17.5)	0.25 (6.3)	9007MA9	0.04 (0.09)
2 (51)	0.69 (17.5)	0.25 (6.3)	9007CA9	0.04 (0.09)
2.5 (63.5)	0.69 (17.5)	0.25 (6.3)	9007DA9	0.04 (0.09)
3 (76)	0.69 (17.5)	0.25 (6.3)	9007EA9	0.04 (0.09)

##### Lever arms with roller on opposite side to standard

Lever arm	Roller on opposite side		Catalog number	Weight kg (lb)
Length (a) in. (mm)	Diameter (b) in. (mm)	Width (c) in. (mm)		
0.88 (22)	0.63 (16)	0.25 (6.3)	9007AA5	0.04 (0.09)
	0.63 (16)	0.63 (16)	9007AA6	0.04 (0.09)
1.38 (35)	0.75 (19)	0.25 (6.3)	9007BA15	0.04 (0.09)
	0.63 (16)	0.25 (6.3)	9007BA5	0.04 (0.09)
	0.63 (16)	0.63 (16)	9007BA6	0.04 (0.09)
1.5 (38)	0.75 (19)	0.25 (6.3)	9007MA15	0.04 (0.09)
	0.63 (16)	0.25 (6.3)	9007MA5	0.04 (0.09)
2 (51)	0.63 (16)	0.63 (16)	9007MA6	0.04 (0.09)
	0.75 (19)	0.25 (6.3)	9007CA15	0.04 (0.09)
2.5 (63.5)	0.63 (16)	0.25 (6.3)	9007CA5	0.04 (0.09)
	0.63 (16)	0.63 (16)	9007CA6	0.04 (0.09)
	0.75 (19)	0.25 (6.3)	9007DA15	0.04 (0.09)
	0.63 (16)	0.25 (6.3)	9007DA5	0.04 (0.09)
3 (76)	0.63 (16)	0.63 (16)	9007DA6	0.04 (0.09)
	0.75 (19)	0.25 (6.3)	9007EA15	0.04 (0.09)
	0.63 (16)	0.25 (6.3)	9007EA5	0.04 (0.09)
	0.63 (16)	0.63 (16)	9007EA6	0.04 (0.09)

##### Lever arms with roller countersunk roller pin

Arm	Roller (countersunk roller pin)		Catalog number	Weight kg (lb)
Length (a) in. (mm)	Diameter (b) in. (mm)	Width (c) in. (mm)		
1.5 (38)	0.75 (19)	0.25 (6.3)	9007MA31	0.03 (0.07)
2 (51)	0.75 (19)	0.25 (6.3)	9007CA31	0.04 (0.08)
2.5 (63.5)	0.75 (19)	0.25 (6.3)	9007DA31	0.04 (0.09)

##### Lever arms with cable operated with eyebolt (I.D.) instead of roller

Arm	Cable	Catalog number	Weight kg (lb)
Length in. (mm)	Length in. (mm)		
1.5 (38)	0.38 (9.6)	9007MA22	0.05 (0.10)

# Limit Switches

## 9007C Heavy Duty Industrial—Plug-in Body, Metal

### Lever Arms for Rotary Heads

DF563135

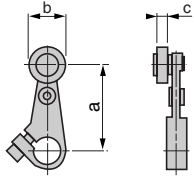

a: Length of lever Arm  
b: Roller diameter  
c: Roller width

Flat steel lever arms with standard roller (1)				
Arm Length(a) in. (mm)	Roller		Catalog number	Weight kg (lb)
	Diameter (b) in. (mm)	Width (c) in. (mm)		
<b>Lever arms with steel roller</b>				
0.88 (22)	0.63 (16)	0.25 (6.3)	9007AA1S	0.01 (0.03)
	0.63 (16)	0.63 (16)	9007AA2S	0.01 (0.03)
1.38 (35)	0.63 (16)	0.25 (6.3)	9007BA1S	0.01 (0.03)
	0.63 (16)	0.63 (16)	9007BA2S	0.01 (0.03)
2 (51)	0.63 (16)	0.25 (6.3)	9007CA1S	0.03 (0.07)
	0.63 (16)	0.63 (16)	9007CA2S	0.04 (0.08)
2.5 (63.5)	0.63 (16)	0.25 (6.3)	9007DA1S	0.04 (0.08)
	0.63 (16)	0.63 (16)	9007DA2S	0.04 (0.08)
3 (76)	0.63 (16)	0.25 (6.3)	9007EA1S	0.04 (0.08)
	0.63 (16)	0.63 (16)	9007EA2S	0.04 (0.08)
<b>Lever arms with nylon roller</b>				
1.38 (35)	1 (25.4)	0.25 (6.3)	9007BA4S	0.01 (0.03)
1.5 (38)	0.75 (19)	0.25 (6.3)	9007MA18S	0.01 (0.03)
2 (51)	1 (25.4)	0.25 (6.3)	9007CA4S	0.03 (0.07)
2.5 (63.5)	1 (25.4)	0.25 (6.3)	9007DA4S	0.04 (0.08)
3 (76)	1 (25.4)	0.25 (6.3)	9007EA4S	0.04 (0.08)
<b>Lever arms without roller</b>				
0.88 (22)	—	—	9007AA0S	
1.38 (35)	—	—	9007BA0S	0.01 (0.02)
2 (51)	—	—	9007CA0S	0.03 (0.06)
2.5 (63.5)	—	—	9007DA0S	0.03 (0.07)
3 (76)	—	—	9007EA0S	0.03 (0.07)

1. Material is hardened, oil-impregnated, sintered iron.

90° Forked cast zinc lever arms					
Arm Length(a) in. (mm)	Roller position	Roller		Catalog number	Weight kg (lb)
		Diameter(b) in. (mm)	Width(c) in. (mm)		
<b>Lever arms with steel roller</b>					
1.5 (38)	Rollers on same side	0.75 (19)	0.25 (6.3)	9007LA4	0.05 (0.12)
		0.63 (16)	0.25 (6.3)	9007LA1	0.07 (0.15)
	R.H. Roller on opposite side	0.75 (19)	0.25 (6.3)	9007LA5	0.05 (0.12)
		0.63 (16)	0.25 (6.3)	9007LA2	0.07 (0.15)
	L.H. Roller on opposite side	0.75 (19)	0.25 (6.3)	9007LA6	0.05 (0.12)
		0.63 (16)	0.25 (6.3)	9007LA3	0.07 (0.15)
<b>Lever arms with nylon rollers</b>					
1.5 (38)	Rollers on same side	0.75 (19)	0.25 (6.3)	9007LA16	0.04 (0.09)
			1 (25.4)	9007LA10	0.06 (0.14)
	R.H. Roller on opposite side	0.75 (19)	0.25 (6.3)	9007LA17	0.04 (0.09)
			1 (25.4)	9007LA11	0.06 (0.14)
	L.H. Roller on opposite side	0.75 (19)	0.25 (6.3)	9007LA18	0.04 (0.09)
			1 (25.4)	9007LA12	0.06 (0.14)
<b>Lever arms with ball bearing rollers</b>					
1.5 (38)	Rollers on same side	0.69 (17.5)	0.25 (6.3)	9007LA7	0.11 (0.25)
	R.H. Roller on opposite side	0.69 (17.5)	0.25 (6.3)	9007LA8	0.11 (0.25)
	L.H. Roller on opposite side	0.69 (17.5)	0.25 (6.3)	9007LA9	0.11 (0.25)

DF531892



9007LA4

Dimensions:  
page 193



# Limit Switches

## 9007C Heavy Duty Industrial—Plug-in Body, Metal

### Lever Arms for Rotary Heads

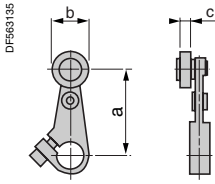

a: Length of lever Arm  
b: Roller diameter  
c: Roller width



9007RA11

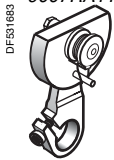

9007BA3

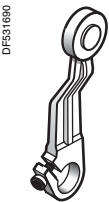

9007KA11

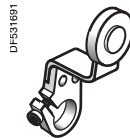

9007KB11

One-way lever arm					
Arm		Steel roller		Catalog number	Weight kg (lb)
Length (a) in. (mm)		Diameter (b) in. (mm)	Width (c) in. (mm)		
<b>Lever arm with standard roller</b>					
1.5 (38)		0.75 (19)	0.25 (6.3)	9007RA11	0.05 (0.12)
<b>Lever arm with nylon roller</b>					
1.5 (38)		0.75 (19)	0.25 (6.3)	9007RA18	0.05 (0.12)
<b>Lever arm with ball bearing roller</b>					
1.5 (38)		0.69 (17.5)	0.25 (6.3)	9007RA9	0.05 (0.12)
<b>Lever arm with rod type</b>					
5 (127)		–	–	9007FA2	0.05 (0.12)
One-way cast zinc roller lever arm					
Arm		Roller		Catalog number	Weight kg (lb)
Length (a) in. (mm)		Diameter (b) in. (mm)	Width (c) in. (mm)		
<b>Cast arm with steel roller</b>					
1.38 (35)		1.25 (32)	0.25 (6.3)	9007BA3	0.07 (0.15)
1.5 (38)		1.25 (32)	0.25 (6.3)	9007MA3	0.10 (0.23)
2 (51)		1.25 (32)	0.25 (6.3)	9007CA3	0.12 (0.27)
2.5 (63.5)		1.25 (32)	0.25 (6.3)	9007DA3	0.12 (0.27)
3 (76)		1.25 (32)	0.25 (6.3)	9007EA3	0.13 (0.29)
<b>Flat steel arm with steel roller</b>					
1.38 (35)		1.25 (32)	0.25 (6.3)	9007BA3S	0.07 (0.15)
2 (51)		1.25 (32)	0.25 (6.3)	9007CA3S	0.10 (0.23)
2.5 (63.5)		1.25 (32)	0.25 (6.3)	9007DA3S	0.12 (0.27)
3 (76)		1.25 (32)	0.25 (6.3)	9007EA3S	0.13 (0.29)
Offset type cast zinc lever arm					
Offset lever arm		Roller		Catalog number	Weight kg (lb)
Length in. (mm)	Offset	Diameter in. (mm)	Width in. (mm)		
<b>Offset cast zinc arm with steel roller</b>					
2 (51)	0.44 (11)	0.63 (16)	0.25 (6.3)	9007KA1	0.04 (0.08)
		0.63 (16)	0.63 (16)	9007KA2	0.04 (0.08)
		0.75 (19)	0.25 (6.3)	9007KA11	0.04 (0.09)
		0.75 (19)	0.63 (16)	9007KA12	0.05 (0.12)
1.5 (38)	0.88 (22)	0.75 (19)	0.25 (6.3)	9007KB11	0.04 (0.10)
		0.75 (19)	0.25 (6.3)	9007KB15	0.04 (0.10)
<b>Offset cast zinc arm with ball bearing roller</b>					
2 (51)	0.44 (11)	0.69 (17.5)	0.25 (6.3)	9007KA9	0.04 (0.10)
<b>Offset cast zinc arm with nylon roller</b>					
2 (51)	0.44 (11)	0.75 (19)	0.25 (6.3)	9007KA18	0.04 (0.10)
		0.75 (19)	1 (25.4)	9007KA21	0.04 (0.10)

# Limit Switches

## 9007C Heavy Duty Industrial—Plug-in Body, Metal

### Lever Arms for Rotary Heads

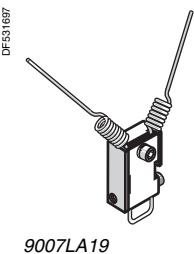
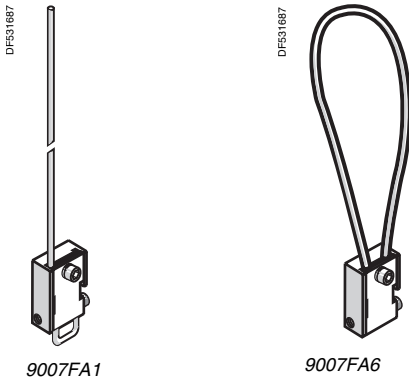
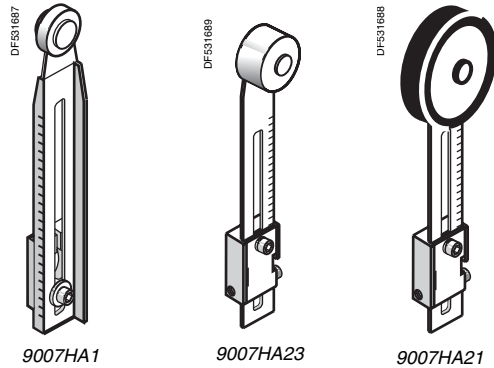
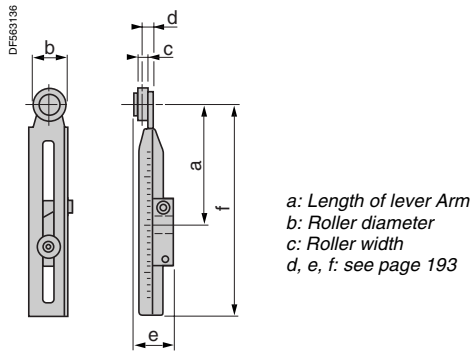

Adjustable length lever arm				
Lever arm	Roller		Catalog number	Weight kg (lb)
Dimensions length (a) in. (mm)	Diameter (b) in. (mm)	Width (c) in. (mm)		
<b>Adjustable length arm with steel roller</b>				
Non-bendable, adjustable from 0.88 (22) to 4 (101)	0.63 (16)	0.25 (6.3)	9007HA1	0.05 (0.12)
	0.63 (16)	0.63 (16)	9007HA2	0.07 (0.14)
Bendable, adjustable from 0.88 (22) to 4 (101)	0.63 (16)	0.25 (6.3)	9007HA5	0.06 (0.14)
	0.63 (16)	0.63 (16)	9007HA6	0.04 (0.18)
<b>Adjustable length arm with nylon roller</b>				
Non-bendable, adjustable from 0.88 (22) to 4 (101)	0.63 (16)	0.25 (6.3)	9007HA4	0.05 (0.12)
	1 (25.4)	0.63 (16)	9007HA22	0.06 (0.13)
Bendable, adjustable from 0.88 (22) to 4 (101)	0.63 (16)	0.25 (6.3)	9007HA8	0.06 (0.14)
	1.0 (16)	0.63 (16)	9007HA23	0.07 (0.16)
	2 (51)	0.25 (6.3)	9007HA26	0.08 (0.17)
<b>Adjustable length arm with ball bearing roller</b>				
Non-bendable, adjustable from 0.88 (22) to 4 (101)	0.69 (17.5)	0.25 (6.3)	9007HA24	0.06 (0.13)
Bendable, adjustable from 0.88 (22) to 4 (101)	0.69 (17.5)	0.25 (6.3)	9007HA25	0.07 (0.16)
<b>Adjustable length arm with ball Delrin® roller</b>				
Bendable, adjustable from 0.88 (22) to 4 (101)	1.63 (41)	0.25 (6.3)	9007HA20	0.07 (0.16)
<b>Adjustable length arm with rubber tire roller</b>				
Bendable, adjustable from 0.88 (22) to 4 (101)	2.13 (54)	0.5 (12.7)	9007HA21	0.10 (0.22)
<b>Adjustable length arm without roller</b>				
Non-bendable, adjustable from 0.88 (22) to 4 (101)	–	–	9007HA0	0.15 (0.33)
Bendable, adjustable from 0.88 (22) to 4 (101)	–	–	9007HA9	0.11 (0.25)
<b>Rod type lever arm</b>				
Description	Length in. (mm)	Catalog number		Weight kg (lb)
<b>Rod</b>				
Stainless steel rod	10 (254)		9007FA1	0.07 (0.15)
Spring rod, steel	12 (304)		9007FA3	0.07 (0.15)
Spring rod, Delrin®	12 (304)		9007FA5	0.07 (0.15)
Looped Delrin rod arm	–		9007FA6	0.05 (0.11)
<b>90° forked rod</b>				
Spring rods, steel	2.5 (63.5)		9007LA19	0.06 (0.13)

Dimensions:  
page 193

# Limit Switches

## 9007C Heavy Duty Industrial—Plug-in Body, Metal

### Lever Arms for Rotary Heads

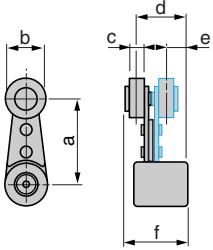

a: Length of lever Arm  
 b: Roller diameter  
 c: Roller width  
 d, e: see page 193

360° angular adjustable lever arm					
360° angular adjustable lever arm		Roller		Catalog number	Weight kg (lb)
Length (a) in. (mm)	Roller (1) position	Diameter (b) in. (mm)	Width (c) in. (mm)		
<b>Lever arms with steel roller</b>					
0.88 (22)	Roller outside	0.63 (16)	0.25 (6.3)	9007AA1M	0.09 (0.20)
	Roller inside	0.63 (16)	0.25 (6.3)	9007AA5M	0.09 (0.20)
	Roller outside	0.75 (19)	0.25 (6.3)	9007AA11M	0.09 (0.20)
1.38 (35)	Roller outside	0.63 (16)	0.25 (6.3)	9007BA1M	0.09 (0.22)
	Roller inside	0.63 (16)	0.25 (6.3)	9007BA5M	0.10 (0.22)
	Roller outside	0.75 (19)	0.25 (6.3)	9007BA11M	0.10 (0.22)
1.5 (38)	Roller outside	0.63 (16)	0.25 (6.3)	9007MA1M	0.11 (0.24)
	Roller inside	0.63 (16)	0.25 (6.3)	9007MA5M	0.11 (0.24)
	Roller outside	0.75 (19)	0.25 (6.3)	9007MA11M	0.11 (0.24)
2 (51)	Roller outside	0.63 (16)	0.25 (6.3)	9007CA1M	0.11 (0.24)
	Roller inside	0.63 (16)	0.25 (6.3)	9007CA5M	0.11 (0.24)
	Roller outside	0.75 (19)	0.25 (6.3)	9007CA11M	0.11 (0.25)
2.5 (63.5)	Roller outside	0.63 (16)	0.25 (6.3)	9007DA1M	0.11 (0.25)
	Roller inside	0.63 (16)	0.25 (6.3)	9007DA5M	0.12 (0.27)
	Roller outside	0.75 (19)	0.25 (6.3)	9007DA11M	0.12 (0.27)
3 (76)	Roller outside	0.63 (16)	0.25 (6.3)	9007EA1M	0.12 (0.27)
	Roller inside	0.63 (16)	0.25 (6.3)	9007EA5M	0.12 (0.27)
	Roller outside	0.75 (19)	0.25 (6.3)	9007EA11M	0.13 (0.29)
<b>Lever arms with nylon roller</b>					
0.88 (22)	Roller outside	0.63 (16)	0.25 (6.3)	9007AA8M	0.09 (0.20)
		0.75 (19)	0.25 (6.3)	9007AA18M	0.09 (0.20)
1.38 (35)	Roller outside	0.63 (16)	0.25 (6.3)	9007BA8M	0.11 (0.25)
		0.75 (19)	0.25 (6.3)	9007BA18M	0.11 (0.25)
1.5 (38)	Roller outside	0.63 (16)	0.25 (6.3)	9007MA8M	0.10 (0.23)
		0.75 (19)	0.25 (6.3)	9007MA18M	0.11 (0.25)
2 (51)	Roller outside	0.63 (16)	0.25 (6.3)	9007CA8M	0.12 (0.27)
		0.75 (19)	0.25 (6.3)	9007CA18M	0.12 (0.27)
2.5 (63.5)	Roller outside	0.63 (16)	0.25 (6.3)	9007DA8M	0.12 (0.27)
		0.75 (19)	0.25 (6.3)	9007DA18M	0.12 (0.27)
3 (76)	Roller outside	0.63 (16)	0.25 (6.3)	9007EA8M	0.12 (0.26)
		0.75 (19)	0.25 (6.3)	9007EA18M	0.12 (0.27)
<b>Lever arms with ball bearing roller</b>					
0.88 (22)	Roller outside	0.69 (17.5)	0.25 (6.3)	9007AA9M	0.10 (0.23)
1.38 (35)	Roller outside	0.69 (17.5)	0.25 (6.3)	9007BA9M	0.11 (0.24)
1.5 (38)	Roller outside	0.69 (17.5)	0.25 (6.3)	9007MA9M	0.19 (0.26)
2 (51)	Roller outside	0.69 (17.5)	0.25 (6.3)	9007CA9M	0.19 (0.26)
2.5 (63.5)	Roller outside	0.69 (17.5)	0.25 (6.3)	9007DA9M	0.12 (0.27)
3 (76)	Roller outside	0.69 (17.5)	0.25 (6.3)	9007EA9M	0.13 (0.28)

(1) Roller can be changed in the field from roller outside to roller inside position or vice versa.

# Limit Switches

## 9007C Heavy Duty Industrial—Plug-in Body, Metal Bodies and Heads, Dimensions

### Body Standard

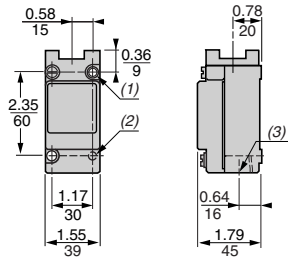

Dual dimensions:  $\frac{\text{in.}}{\text{mm}}$

1. 2 x 0.20/5 x 0.22/6 HLS.
2. 2 x 10-24 Tapped HLS Back Mtg 0.29/7 DP.
3. 1/2 14 NPT.

### Compact

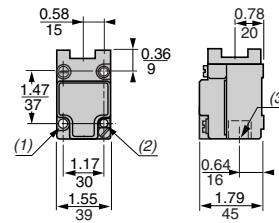

Dual dimensions:  $\frac{\text{in.}}{\text{mm}}$

1. 2 x 0.20/5 HLS.
2. 2 x 10-24 Tapped HLS Back Mtg 0.20/5 DP.
3. 1/2 14 NPT.

### Side plunger heads

#### 9007F

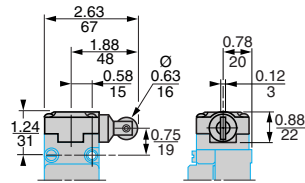

#### 9007G

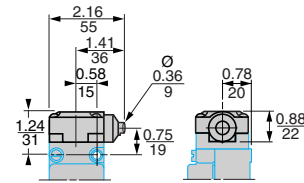

#### 9007GD

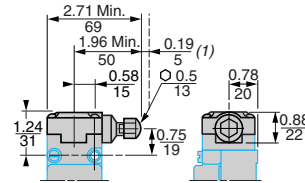

#### 9007H

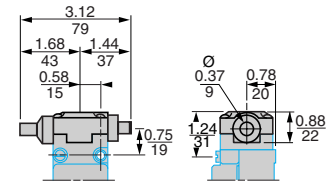

### Top plunger heads

#### 9007D

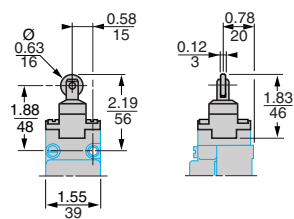

#### 9007E

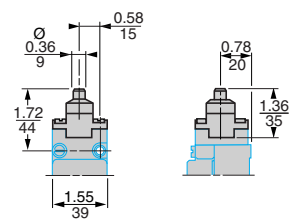

#### 9007ED

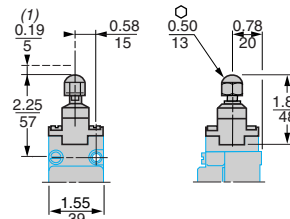

1. Adjustable

### Rotary heads

#### 9007C

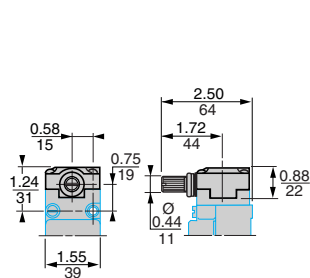

### Multi-directional heads

#### 9007JKC

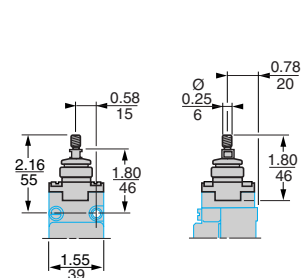

#### 9007J

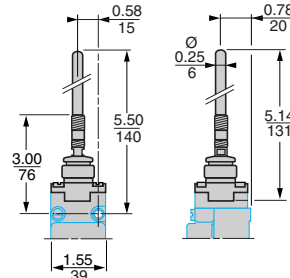

#### 9007KC

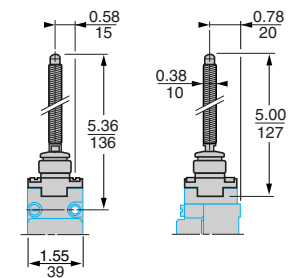

### Multi-directional heads (continued)

#### 9007K

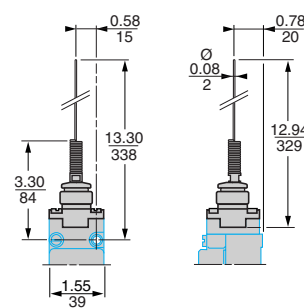

#### 9007L

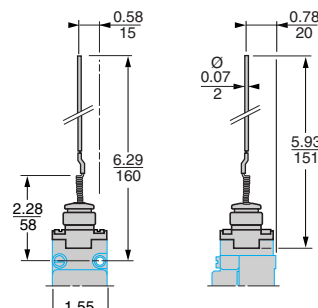

Catalog numbers:  
pages 184 and 185

# Limit Switches

## 9007C Heavy Duty Industrial—Plug-in Body, Metal Lever Arms for Rotary Heads, Dimensions

### Lever arms

9007AA\*\*, BA\*\*, CA\*\*, DA\*\*, EA\*\*, FA\*\*, KA\*\*, LA\*\*, MA\*\*, RA\*\*

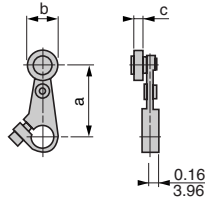

a: Length of lever Arm  
b: Roller diameter  
c: Roller width

a, b, c: pages 186 to 189

### Adjustable length lever arms

9007HA\* and 9007HA\*\*\*

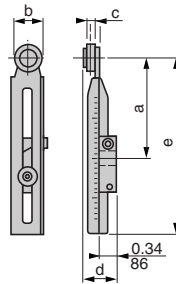

a: Length of lever Arm  
b: Roller diameter  
c: Roller width  
d = 0.38/10  
e = 4.38/111

a, b, c: page 190

### 360° angular adjustable lever arms

9007AA\*\*M, 9007BA\*\*M, 9007CA\*\*M, 9007DA\*\*M, 9007EA\*\*M, 9007MA\*\*M

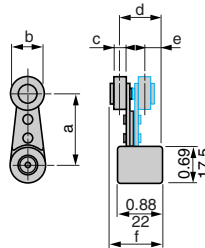

a: Length of lever Arm  
b: Roller diameter  
c: Roller width  
d = 0.84/21  
e = 0.38/10  
f = 1.05/27

a, b, c: page 191

### Rod type lever arms

9007FA1

9007FA6

9007LA19

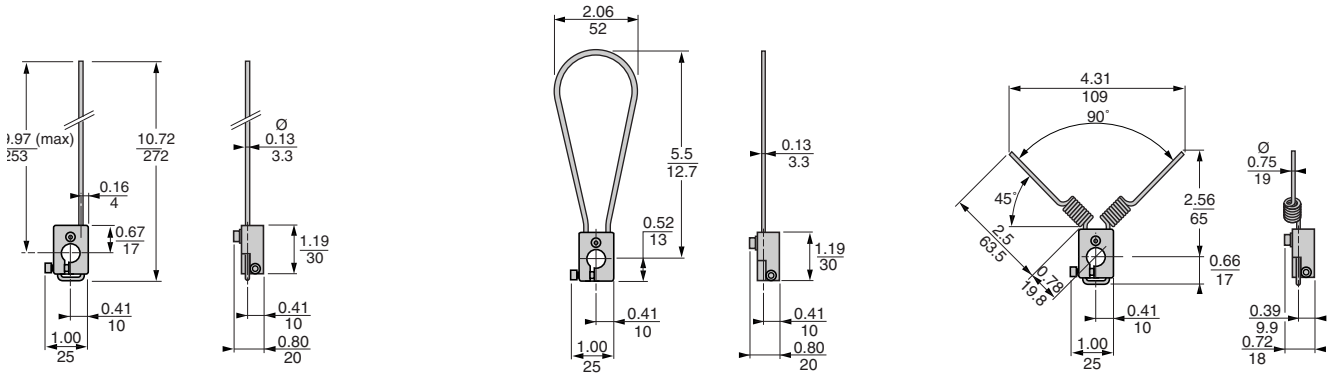

Catalog numbers:  
pages 186 to 191

# Limit Switches

## 9007C Heavy Duty Industrial—Non-Plug-in Body, Metal

### Hazardous Location

#### Hazardous Non-Plug-in Body Type (1)

With head for linear movement  
side plunger

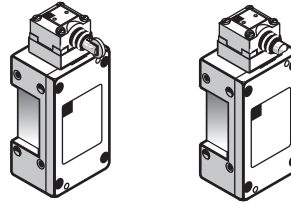

Page 196

top plunger

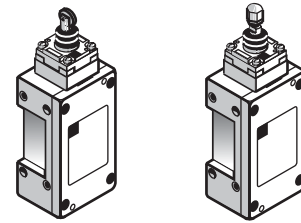

Page 197

With head for rotary movement (lever)

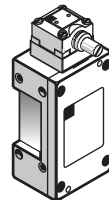

Page 198

With head for multi-directional movement

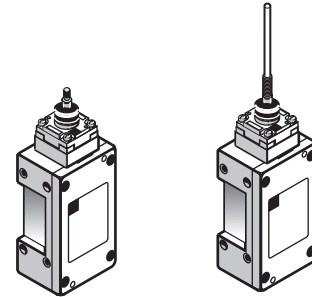

Page 199

1. Factory modifications: see pages 172 to 176.

#### Application Information—Hazardous Locations

##### Classification of hazardous locations

Hazardous locations are those areas that **may** have flammable gases or combustible dusts present in quantities sufficient to produce an explosive or ignitable mixture. These gases, dusts, may always be present or may only be present in abnormal situations. The National Electrical Code (NEC) describes these areas in Articles 500 through 503 and divides them into three types of categories: Class, Group, Division.

- **Classes**

The *Classes* (I, II, III) differentiate between the type of hazardous materials: I is for gases, II is for dusts, and III is for fibers.

- **Groups**

The *Groups* (A, B, C, D, E, F, and G) further subdivide each class according to the relative explosive force of the materials. Group A atmosphere is acetylene which has a higher explosive force than Group B (which may contain hydrogen, for example); and Group B has a higher explosive force than Group D, etc.

- **Divisions**

The *Divisions* (1 and 2) refer to the presence of these hazardous gases and dusts. Division 1 areas can have these gases or dusts present **at all times** under **normal operating conditions** in an ignitable concentration. Division 2 areas **only** have **ignitable concentrations** of dusts or gases present during **abnormal conditions**, such as machine failures or container breakage.

The table below summarizes the classifications described above.

#### Summary of Classification Chart

Class	Division	Group
I. Gas	1. <b>Hazard May Exist</b> May Exist In Atmosphere Under Normal Operating Conditions	A. Acetylene B. Manufactured Gases Containing Hydrogen C. Petrochemicals (e.g. ethylene) D. Petrochemicals (e.g. alcohol)
	2. <b>Potential Hazard</b> A. May be present in atmosphere only under abnormal circumstances.	A. Acetylene B. Manufactured Gases Containing Hydrogen C. Petrochemicals (e.g. ethylene) D. Petrochemicals (e.g. alcohol)
II. Dust	1. <b>Hazard May Exist</b> May Exist In Atmosphere Under Normal Operating Conditions	E. Conductive and Combustible Dust (Resistivity $\leq 10^5$ ohms/cm) F. Carbonaceous Dusts (Resistivity $> 10^2$ ohm/cm but $< 108$ ohm/cm) G. Non-Conductive Combustible Dust (Resistivity $> = 105$ ohms/cm)
	2. <b>Potential Hazard</b> A. May be present in atmosphere only under abnormal circumstances.	G. Non-Conductive Combustible Dust (Resistivity $> = 105$ ohms/cm)
III. Fibers	1. <b>Production Areas</b>	Easily Ignitable Fibers
	2. <b>Handling and Storage Areas</b>	Easily Ignitable Fibers

# Limit Switches

## 9007C Heavy Duty Industrial—Non-Plug-in Body, Metal Hazardous Location

Environment characteristics		
Conforming to standards	Products	NEMA 250, EN 60947-1, EN 60947-5-1, IEC 60947, UL 508, C22-2-14-95, CE conformity documentation
	Machine assemblies	IEC 60204-1
Product certifications		UL, CSA, CE
Protective treatment		Epoxy powder coat
Ambient air temperature (Lever/rotary head)	Operation	-20...+185 °F (-29...+85 °C), wider range available
	Storage	-20...+185 °F (-29...+85 °C), wider range available
Vibration resistance	Conforming to IEC 60068-2-6	25 gn (10...150 Hz, 11 ms) (C86F switch good for 18.5g only)
Shock resistance	Conforming to IEC 60068-2-27	60 gn (9 ms) 40 gn (9 ms) for reed switch
	Conforming to IEC 61140	Class 0
Degree of protection	Conforming to IEC 60529	IP 67
Cable entry or connector	Depending on model	1/2-14 NPT, M20 X 1.5, ISO cable entry, 5-pin mini connector, 4-pin micro connector
Materials	Bodies, heads, levers	Bodies in aluminum, heads in Zamak <sup>®</sup> zinc alloy, levers and rods in zinc, steel, stainless steel, Delrin <sup>®</sup> resin.
Contact block characteristics		
Rated operational characteristics hard contacts -AC Voltage	9007CR53 (single pole)	NEMA A600 (Ue = 600 V, Ie = 1.2 A); Ithe = 10 A
	9007CR61 (two pole)	NEMA A600 (Ue = 600 V, Ie = 1.2 A); Ithe = 10 A
	9007CR65 (two pole two stage)	NEMA A600 (Ue = 600 V, Ie = 1.2 A); Ithe = 10 A
	9007CR67 (two pole neutral)	NEMA A600 (Ue = 600 V, Ie = 1.2 A); Ithe = 10 A
Rated operational characteristics hard contacts -DC Voltage	9007CR53 (single pole)	NEMA Q600 (Ue = 600 V, Ie = 0.1 A); Ithe = 2.5 A
	9007CR61 (two pole)	NEMA R300 (Ue = 250 V, Ie = 0.11 A); Ithe = 1.0 A
	9007CR65 (two pole two stage)	NEMA R300 (Ue = 250 V, Ie = 0.11 A); Ithe = 1.0 A
	9007CR67 (two pole neutral)	NEMA R300 (Ue = 250 V, Ie = 0.11 A); Ithe = 1.0 A
Rated insulation voltage		600 V
Rated Impulse Withstand Voltage		2,500 Vac for 1 minute for CE; 2,200 Vac for 1 minute for UL; and 2,640 Vac for 1 s for CSA
Positive Opening	Special Y1561	Special Y1561 (one pole slow break only) ↻
Short Circuit Protection		10 A. Bussman Class CC KTK-R-10 fuse non-time-delay
Terminal wire sizes (Cabling/Screw Clamp)		1 or 2, 12–22 AWG (2.05–0.644 mm <sup>2</sup> ) wires maximum
Maximum Actuation Speed		50fpm / 90fpm (15.2 m/min / 27.4 m/min) with 45 degree cam angle, levers only
Electrical Durability		1 million operating cycles

Types of contact elements			IEC 60947-5-1			NEMA			JIS			
	Form	Symbol	Description	Form	Symbol	Description	Form	Symbol	Description	Form	Symbol	Description
A			Single break	A		-	3		-			Double break
X				B		-	2		-			Double break
B			Single break	C		-	1		-			Single break
Y				Z		"Same polarity" only						Double break
Za			Same polarity									
Zb			Electrically separate									

# Limit Switches

## 9007C Heavy Duty Industrial—Non-Plug-in Body, Metal Hazardous Location

Type of head **Side Plunger (mounting by the body)**

Hazardous location non-plug-in body type

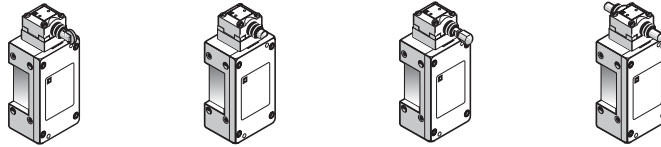

Type of operator	Side roller plunger spring return vertical roller (1)	Side push rod plunger spring return	Side push rod plunger adjustable (2) spring return	Side push rod plunger maintained contact
------------------	---	-------------------------------------	--	--

### Catalog numbers

<b>1 N.O. 1 N.C. snap action</b> 	<b>9007CR53F</b> 	<b>9007CR53G</b> 	<b>9007CR53GD</b> 	<b>9007CR53H</b> 
<b>2 N.O. 2 N.C. snap action</b> 	<b>9007CR61F</b> 	<b>9007CR61G</b> 	<b>9007CR61GD</b> 	<b>9007CR61H</b> 
<b>2 N.O. 2 N.C. Two stage snap action</b> 	<b>9007CR65F</b> 	<b>9007CR65G</b> 	<b>9007CR65GD</b> 	

Weight, kg (lb)	1.020 (2.25)	1.020 (2.25)	1.020 (2.25)	1.020 (2.25)
-----------------	--------------	--------------	--------------	--------------

Contact operation	 ■ contact closed □ contact open
-------------------	--

### Characteristics (nominal operating data)

Switch actuation	On end		
Type of actuation			
Pre-travel	2 mm (0.08")		3.6 mm (0.14")
Pre-travel two Stage	First stage	2 mm (0.08")	
	First stage to second stage	0.5 mm (0.02")	
Total travel	6.3 mm (0.25")		
Differential	0.8 mm (0.03")		
Reverse overtravel	-		
Minimum force or torque	1 pole & 2 pole	4 lb (17.8 N)	7 lb (31.1 N)
Terminal wire sizes (Cabling/Screw Clamp)	1 or 2, 12–22 AWG (2.05–0.644 mm <sup>2</sup> ) wires maximum		
Repeatability (linear travel of cam)	0.03 mm (0.001")		-
Cable entry	1/2-14 NPT standard, optional M20 x 1.5 mm for ISO cable entry		

- Can be converted to horizontal roller type in the field. To order horizontal roller version add the letter H at the end of the equivalent vertical roller version type.
- To lock the nut in the desired position, crimp the slot near the bottom of the nut.

Dimensions:  
pages 200 and 201



# Limit Switches

## 9007C Heavy Duty Industrial—Non-Plug-in Body, Metal Hazardous Location

Type of head Top Plunger (mounting by the body)

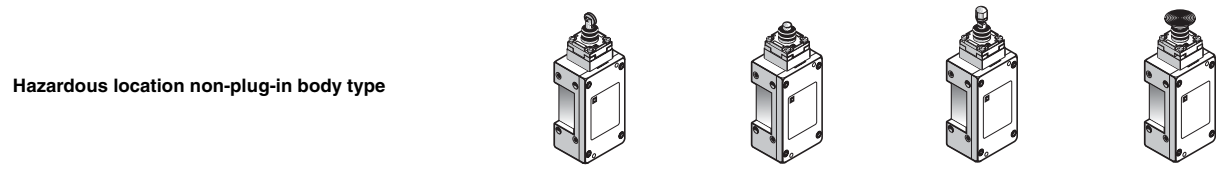

Type of operator	Top roller plunger spring return	Top push rod plunger spring return	Top push rod plunger adjustable (1)	Palm operated (2)
------------------	----------------------------------	------------------------------------	-------------------------------------	-------------------

### Catalog numbers

<b>1 N.O. 1 N.C. snap action</b> 	<b>9007CR53D</b> 	<b>9007CR53E</b> 	<b>9007CR53ED</b> 	<b>9007CR53R (2)</b> 
<b>2 N.O. 2 N.C. snap action</b> 	<b>9007CR61D</b> 	<b>9007CR61E</b> 	<b>9007CR61ED</b> 	<b>9007CR61R (2)</b> 
<b>2 N.O. 2 N.C. Two stage snap action</b> 	<b>9007CR65D</b> 	<b>9007CR65E</b> 	<b>9007CR65ED</b> 	<b>9007CR65R (2)</b> 

<b>Weight, kg (lb)</b>	1.020 (2.25)	1.020 (2.25)	1.020 (2.25)	1.020 (2.25)
<b>Contact operation</b>				

### Characteristics (nominal operating data)

<b>Switch actuation</b>	On end			
<b>Type of actuation</b>				
<b>Pre-travel</b>	2 mm (0.08")			
<b>Pre-travel two Stage</b>	First stage	2 mm (0.08")		
	First stage to second stage	0.3 mm (0.01")		
<b>Total travel</b>	6.3 mm (0.25")			
<b>Differential</b>	0.5 mm (0.02")			
<b>Reverse overtravel</b>	-			
<b>Minimum force or torque</b>	1 pole & 2 pole	3 lb (13.3 N)		7 lb (31.1 N)
<b>Terminal wire sizes</b> (Cabling/Screw Clamp)	1 or 2, 12–22 AWG (2.05–0.644 mm <sup>2</sup> ) wires maximum			
<b>Repeatability</b> (linear travel of cam)	0.03 mm (0.001")			
<b>Cable entry</b>	1/2-14 NPT standard, optional M20 x 1.5 mm for ISO cable entry			

- To lock the nut in the desired position, crimp the slot near the bottom of the nut.
- Does not include mushroom button. Must be ordered separately see page 185.

Dimensions:  
pages 200 and 201

# Limit Switches

## 9007C Heavy Duty Industrial—Non-Plug-in Body, Metal Hazardous Location

Type of head	Rotary (lever arm type) (1)					
Hazardous location non-plug-in body type						
Type of operator	Standard pre-travel spring return	Low differential spring return	Neutral position		Light operating torque spring return	Maintained contact
Type of direction	CW & CCW (2)	CW & CCW (2)	CW & CCW	CW & CCW	CW & CCW (2)	CW (trip) CCW (reset)
<b>Catalog numbers</b>						
1 N.O. 1 N.C. snap action 	9007CR53B2 	9007CR53A2 			9007CR53N2 	9007CR53C 
2 N.O. 2 N.C. snap action 	9007CR61B2 	9007CR61A2 			9007CR61N2 	9007CR61C 
2 N.O. 2 N.C. snap action Neutral position 			9007CR67T10 	9007CR67T5 		
2 N.O. 2 N.C. two stage snap action 	9007CR65B2 	9007CR65A2 			9007CR65N2 	
Weight, kg (lb)	1.020 (2.25)	1.020 (2.25)	1.020 (2.25)	1.020 (2.25)	1.020 (2.25)	1.020 (2.25)
Contact operation	■ contact closed		□ contact open			
<b>Characteristics (nominal operating data)</b>						
Switch actuation	By 30° cam					
Type of actuation						
Pre-travel	10°	5°	10°	5°	10°	45°
Pre-travel two stage						
First stage	10°	5°	—	—	10°	—
First stage to second stage	2.5°	1.5°	—	—	2.5°	—
Total travel	90°					90°
Differential	4°	2°	4°	2°	4°	—
Reverse overtravel	90°					—
Operating torque/force 1 pole & 2 pole	4 lb-in (0.45 N•m)				25 oz-in (0.18 N•m)	3 lb-in (0.34 N•m)
Terminal wire sizes (Cabling/Screw Clamp)	1 or 2, 12–22 AWG (2.05–0.644 mm <sup>2</sup> ) wires maximum					
Repeatability (linear travel of cam)	0.05 mm (± 0.002")	0.03 mm (± 0.001")	0.05 mm (± 0.002")	0.05 mm (± 0.002")	0.05 mm (± 0.002")	0.05 mm (± 0.002")
Cable entry	1/2-14 NPT standard, optional M20 x 1.5 mm for ISO cable entry					
1. Lever arm type must be ordered separately from page 186 to 189. 2. These devices are factory set to operate the contacts in <b>both the CW and CCW directions</b> . <b>Mode of operation</b> is field convertible to CW only or CCW only. <b>To order factory converted devices:</b> For CCW only operation, change the <b>2</b> at the end of the Type number to <b>1</b> (for example: C54B2 becomes C54B1). For CW only operation, delete the <b>2</b> at the end of the Type number (for example, C54B2 becomes C54B). Mode of operation of the lever arm is easily convertible to clockwise or both. Simply pull out and rotate the arrow to the letters representing the desired direction—CW, CCW, or CW/CCW.						

Dimensions:  
pages 200 and 201

# Limit Switches

## 9007C Heavy Duty Industrial—Non-Plug-in Body, Metal Hazardous Location

Type of head Flexible operator (wobble stick) e

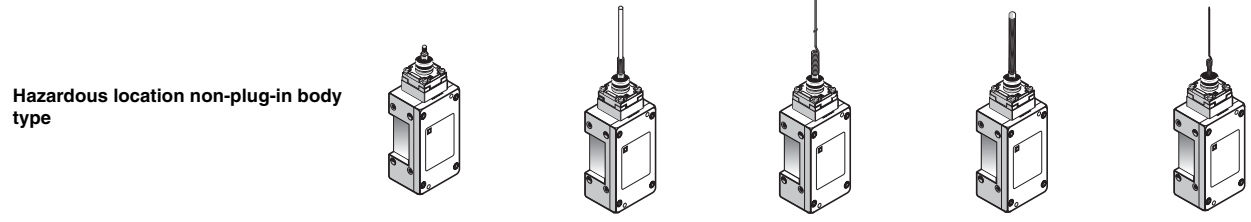

Type of operator	Universal (1)	Wobble stick Delrin® extension (1)	Wobble stick wire extension (1)	Wobble stick coil spring extension (1)	Cat whisker
------------------	---------------	------------------------------------	---------------------------------	--	-------------

### Catalog numbers

1 N.O. 1 N.C. snap action 	9007CR53JKC 	9007CR53J 	9007CR53K 	9007CR53KC 	9007CR53L 
2 N.O. 2 N.C. snap action 	9007CR61JKC 	9007CR61J 	9007CR61K 	9007CR61KC 	9007CR61L 
2 N.O. 2 N.C. Two stage snap action 	9007CR65JKC 	9007CR65J 	9007CR65K 	9007CR65KC 	9007CR65L 
Weight, kg (lb)	1.020 (2.25)	1.020 (2.25)	1.020 (2.25)	1.020 (2.25)	1.020 (2.25)

Contact operation contact closed  
 contact open

### Characteristics (nominal operating data)

Switch actuation	By any moving object from any direction	
Type of actuation		
Pre-travel	10° (any direction)	20°
Pre-travel two Stage		
- First stage	10° (any direction)	20°
- First stage to second stage	4°	5°
Total travel	90°	
Differential	3	6°
Reverse overtravel	-	
Operating torque/force 1 pole & 2 pole	3 lb-in (0.34 N•m)	7 oz-in (0.05 N•m)
Terminal wire sizes (Cabling/Screw Clamp)	1 or 2, 12–22 AWG (2.05–0.644 mm <sup>2</sup> ) wires maximum	
Repeatability (linear travel of cam)	-	
Cable entry	1/2-14 NPT standard, optional M20 x 1.5 mm for ISO cable entry	

1. Wobble stick extensions are available separately for the universal head or as replacements for complete devices (see page 185)

Dimensions:  
pages 200 and 201

# Limit Switches

## 9007C Heavy Duty Industrial—Non-Plug-in Body, Metal Hazardous Location—Dimensions

### Side Plunger 9007C••F

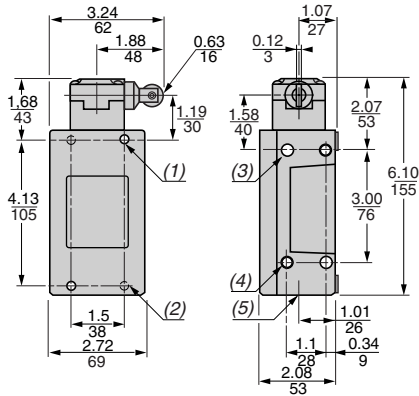

### 9007C••G

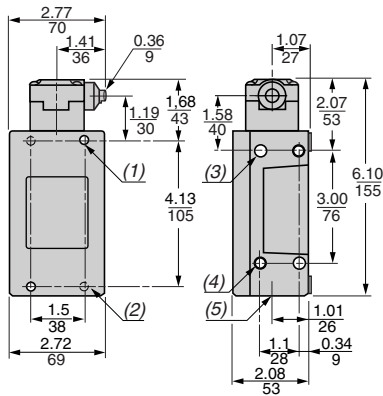

### 9007C••GD

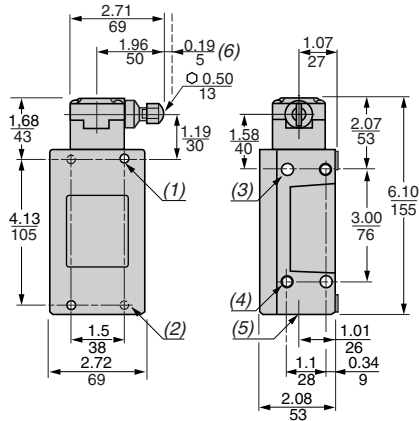

### 9007C••H

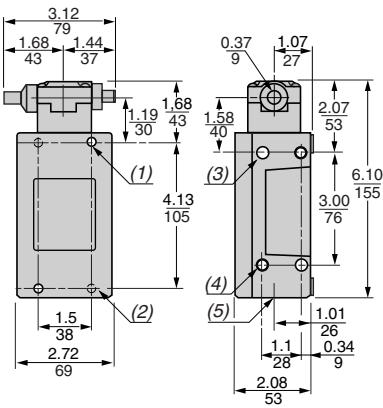

Limit Switches

1. 2 x 0.2777, front Mtg. holes.
2. 2 x 0.63/16 1/4-20 DP UNC-2B back mounting holes.
3. 2 x 0.26/7 dia. holes.
4. 2 1/4-20 UNC-2B, both sides 0.32/8 DP.
5. 1/2 or 3/4 NPT.
6. Adjustable.

Dual dimensions:  $\frac{\text{in.}}{\text{mm}}$

### Top Plunger 9007C••D

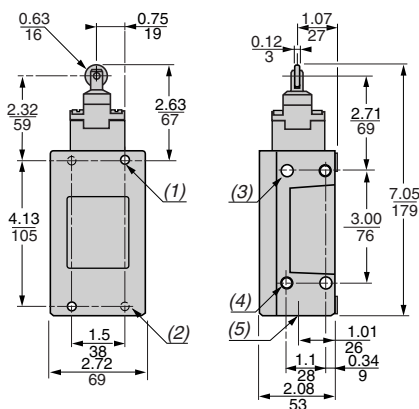

### 9007C••E

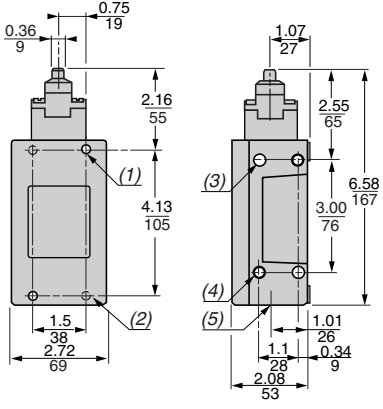

### 9007C••ED

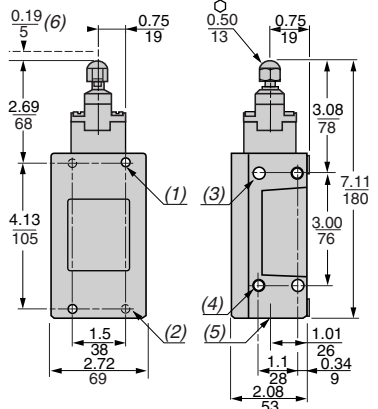

1. 2 x 0.2777, front Mtg. holes.
2. 2 x 0.63/16 1/4-20 DP UNC-2B back mounting holes.
3. 2 x 0.26/7 dia. holes, back Mtg. holes.
4. 2 1/4-20 UNC-2B, both sides 0.32/8 DP.
5. 1/2 or 3/4 NPT.
6. Adjustable.

Dual dimensions:  $\frac{\text{in.}}{\text{mm}}$

# Limit Switches

## 9007C Heavy Duty Industrial—Non-Plug-in Body, Metal Hazardous Location—Dimensions

### Rotary 9007C\*\*\*

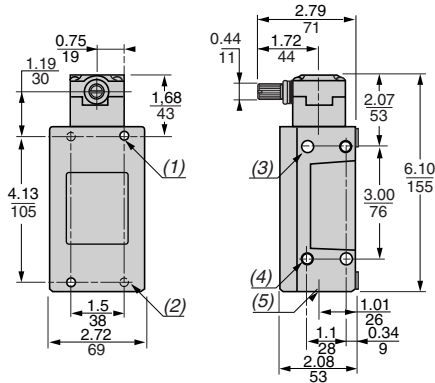

1. 2 x 0.277, front Mtg holes.
2. 2 x 0.63/16 1/4-20 DP UNC-2B back mounting holes.
3. 2 x 0.267 dia. holes, back Mtg. holes.
4. 2 1/4-20 UNC-2B, both sides 0.32/8 DP.
5. 1/2 or 1/4 NPT.

Dual dimensions:  $\frac{\text{in.}}{\text{mm}}$

### Wobble stick 9007C\*\*JKC

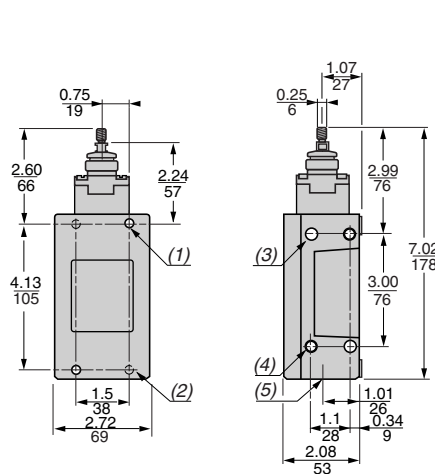

### 9007C\*\*J

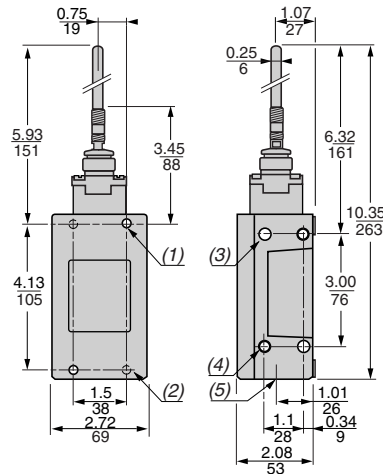

### 9007C\*\*K

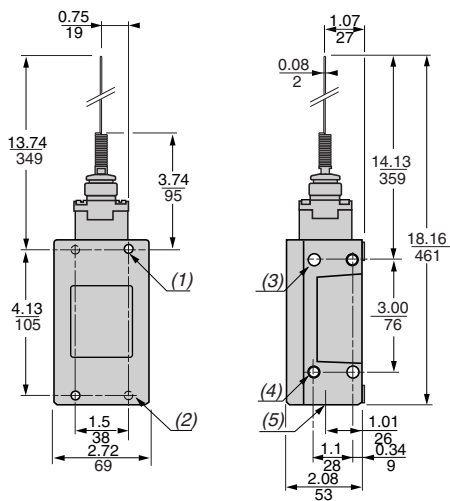

### 9007C\*\*KC

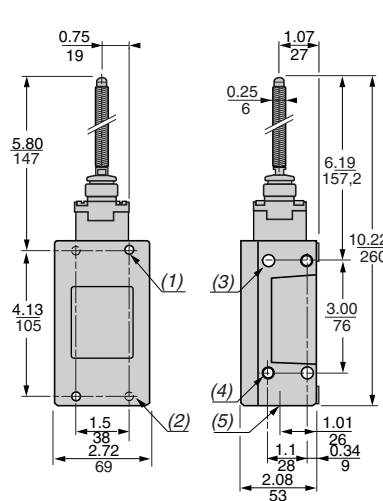

### 9007C\*\*L

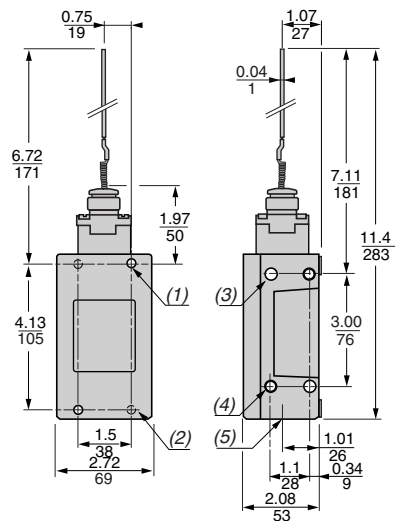

1. 2 x 0.277, front Mtg holes.
2. 2 x 0.63/16 1/4-20 DP UNC-2B back mounting holes.
3. 2 x 0.267 dia. holes, back Mtg. holes.
4. 2 1/4-20 UNC-2B, both sides 0.32/8 DP.
5. 1/2 or 1/4 NPT.

Dual dimensions:  $\frac{\text{in.}}{\text{mm}}$

# Limit Switches

## 9007C Heavy Duty Industrial

### Technical Information

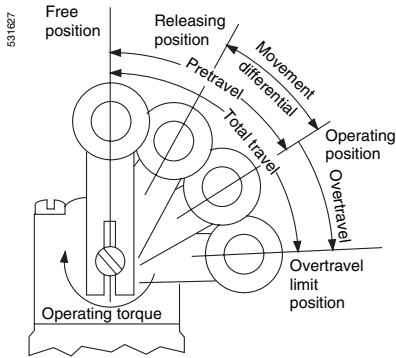

Figure 1: Rotary lever type

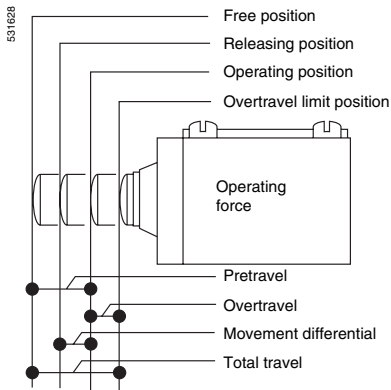

Figure 2: Linear (or Plunger) type

#### Glossary

**CCW**—Counterclockwise only (for lever types).

**CW**—Clockwise only (for lever types).

**Differential**—The movement differential or differential is the distance or angle from the operating position to the releasing position.

**Free or normal position**—Free or normal position is the initial position of the actuator when there is no external force (other than gravity) applied on the actuator.

**Neutral position**—Lever operated switch with a minimum of two contacts. One contact changes state only when lever moves CW. The second contact changes state only when the lever moves CCW. (The center position is the free position.)

**Operating position**—Operating position is the position of the actuator at which the contacts change state.

**Overtravel**—Overtravel is the distance or angle through which the actuator moves when traveling from the operating position to the overtravel limit position.

**Pre-travel**—Pre-travel is the distance or angle through which the actuator moves from the free position to the position at which the contacts change state, the operating position.

**Release position**—Release position is that position of the actuator at which the contacts change state from the operated contact position to the normal contact position.

**Release torque**—Release torque is the value to which the torque on the actuator must be reduced to allow the contacts to change state from the operated position to the normal contact position.

**Actuator-lever**—An actuator is the mechanism of the switch or enclosure which, when moved as intended, will operate the contacts.

**Maintained contact limit switch**—A maintained contact limit switch is a switch which remains in a given condition until actuated to another condition, which is also maintained until further actuation.

**Momentary contact limit switch**—A momentary contact limit switch is a switch which returns from the operated condition to its free or normal circuit condition when the actuating force is removed.

**N.C.**—Normally closed contact, when the switch mechanism is at its free or normal position.

**N.O.**—Normally open contact, when the switch mechanism is at its free or normal position.

**Operating torque**—Operating torque (force) is the minimum torque (force) value which must be applied to the actuator to cause the contacts to change state.

**Overtravel limit position**—Overtravel limit position is that position of the actuator beyond which further overtravel would cause damage to the switch or actuator.

**Repeatability**—Repeatability is the ability to consistently maintain the original operating characteristics. Measured by the difference between the operating position of a new switch and of the same after 1 million operations.

**Total travel**—Total travel is the sum of the pre-travel and overtravel.

**Travel**—Movement of the actuator from its free or normal position when force is applied. (See pre-travel and over travel.)

# Limit Switches

## 9007C Heavy Duty Industrial

### Technical Information

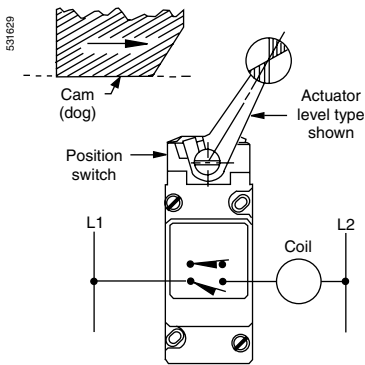

Figure 3—Limit switch

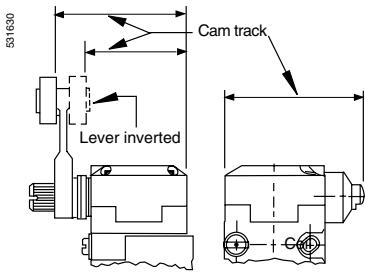

Figure 4—Cam track dimension

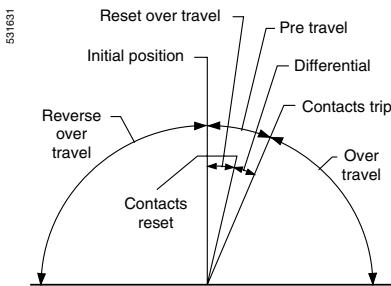

Figure 5—Contact travel

### Glossary (continued)

#### Definition of limit switch terms

There are many terms common to position switches that are not used with other control devices. Before proceeding further, definitions of the commonly used terms should be understood as these terms will be used throughout this document.

**Limit switch**—A device that converts a mechanical motion into an electrical control signal.

**Actuator**—The mechanism of a limit switch that operates the contacts, i.e., lever arm, plunger, wobble stick.

**Cam**—A machine part or component that applies force to the switch actuator causing it to move as intended. Also known as "dog".

**Cam track dimension**—The distance from the switch mounting surface to some point on the roller or actuator.

**Differential**—The distance that the limit switch actuator moves, from the trip point to the reset point of the contacts.

**Direct-acting/positive opening contacts**—Normally closed contacts that are moved directly by the operating shaft. They are slow make-slow break contacts and have a shorter life than snap action contacts due to longer arcing times. In general, these should only be used where movement of actuator must break welded contacts, as in a crane safety limit switch. (Snap action positive opening contacts are available in the Telemecanique® XCKJ limit switch.)

**Maintained contacts**—Contacts that remain in the tripped position until the return travel of the cam moves the switch actuator back and resets the contacts.

**Neutral (free or normal) position limit switch**—A lever arm type switch with two sets of contacts. One set operates when the shaft is rotated clockwise; the other operates when the shaft is rotated counterclockwise.

**Operating force**—The force required to move limit switch actuator to cause the contacts to change state.

**Overtravel**—The distance that the position switch actuator may move beyond the trip point, (see figure 5) without damage to the switch.

**Pole**—The number of moveable contacts in a switching mechanism. A single pole device may be 1 N.O., 1 N.C. or 1 N.O. and 1 N.C. with a single set of moveable contacts is used to bridge those stationary contacts. A double or two pole switch has two moveable contacts.

**Positive break contacts**—Normally closed contacts with a special mechanism to ensure opening. Can be snap acting positive break or direct acting slow make, slow break type. The slow break direct acting type is not recommended for high cycle applications due to shorter life.

**Pre-travel**—The distance that the limit switch actuator must move to trip the contacts.

**Reed contacts**—A mechanism consists of a set of contacts hermetically sealed in a glass envelope and actuated by a magnet attached to the operator. This sealed construction keeps contaminants out of the contact area, making the reed switch ideal for low voltage, low current circuits such as programmable controllers.

**Reset point**—The position of the actuator at which the contacts return to the normal position.

**Snap action contacts**—Contacts that move rapidly to open or closed position and are relatively independent of cam speed. Because of shorter arcing times, snap acting contacts have longer contact life than slow make and break contacts and should be used where fast moving cams are encountered or where good repeat accuracy is required.

**Spring return**—Contacts that return to their original position when the actuating force is removed.

# Limit Switches

## 9007C Heavy Duty Industrial

### Technical Information

#### Definition

**Slow break contacts**—The speed of transfer of the moveable contacts is dependent on the speed of the operator. The amount of travel of the moveable contacts is also dependent on the amount of travel by the operator. Slow make and break contacts have the same trip and reset points, and do not have the differential travel common to snap switches.

**Snap action contacts**—The speed of transfer of the moveable contacts is not dependent on the speed of the operator. The amount of travel of the moveable contacts is also not dependent on the amount of travel by the operator. The movement of the moveable contacts are determined by a preset travel, after this point is reached, the contacts will trip. Snap action contacts have different trip and reset points, the difference is identified as "differential".

**Flexible operators**—Flexible resilient or elastic operators, i.e., wobble sticks, do not ensure direct opening/positive opening action.

**Isolated contacts**—Single-pole double-throw (SPDT) contacts with four terminals which have two isolated contact bars mechanically linked. No polarity restrictions apply. Different (isolated) power supplies can also be applied.

**Same polarity**—Single-pole double throw (SPDT) contacts with four terminals that require the supply to be applied with the same polarity (i.e., L1 or +) on the same side of the contact bar. Two different supplies are not allowed in this configuration. (The loads should always be on the same side of the contact bar.)

**Direct opening contact (also known as positive opening contacts)**—A normally closed contact element coupled with the switch actuator via a non-resilient (non-elastic) member so that full contact opening is obtained when the actuator is moved through the direct opening travel by applying a direct opening force. The contact element will shear open in the event of sticking contacts or broken springs. Proper fusing of the control circuit is required. Direct opening contacts meet IEC 60947-5-1 requirements.

**Direct opening travel (also known as positive opening travel)**—Minimum travel from the actuator free position to the position where the direct opening operation is completed. Usually longer than the normal pre-travel.

**Reed contacts**—Contact mechanism consists of a set of contacts hermetically sealed in a glass envelope and actuated by a magnet attached to the operator. This sealed construction keeps contaminants out of the contact area, making the reed switch the ideal switch for low voltage, low current circuits such as programmable controllers.

*Note: Because reed switches are operated by a magnet, they should not be installed in areas where strong magnetic fields may be present. The devices should always be checked for proper operation after installation.*

#### Polarity

Opposite polarities should not be connected to the contacts of one limit switch unless the limit switch is specifically designed for such service (isolated contacts—no polarity). See page 205.

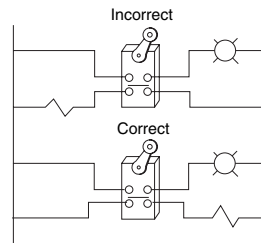

#### Power sources

Power from different sources should not be connected to the contacts of one limit switch unless the switch is specifically designed for such service (isolated contacts—no polarity).

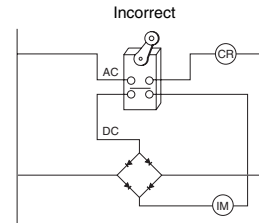



# Limit Switches

## 9007C Heavy Duty Industrial

### Technical Information

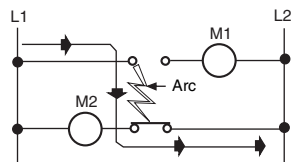
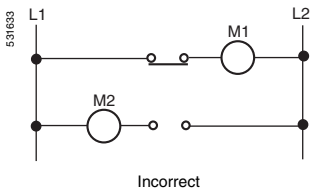
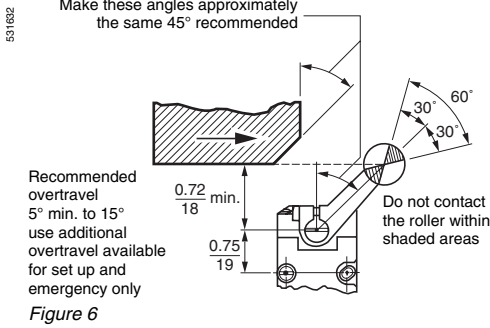

Figure 7—Contacts connected to opposite polarities. Line to line short (bold line) can occur through arc drawn when contacts operate

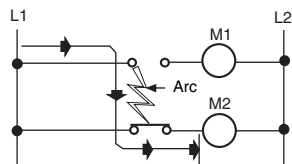
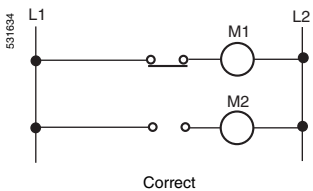

Figure 8—Contacts connected to same polarity. Line to line short cannot occur when contacts operate

### Overriding Cams

The cam trailing edge on overriding cams must also be considered for maximum switch life (see figure 6). Lever arm snap back causes shock loads which reduce switch life. Also, with reversing cams the trailing edge becomes a leading edge on the return stroke. The overtravel of the limit switch should not be exceeded, but 5° minimum to 15° travel past the trip point is recommended. Additional travel should only be used for set up and emergencies. Cam design procedures for limit switches with other than lever arm actuators vary from switch type to switch type and are discussed along with other limit switch application design suggestions in additional literature "Proper Application of Limit Switches" (SM444).

### Contacts

- Make sure the electrical load is within limit switch contact ratings.
- The single pole, double throw contacts of a snap switch used in a limit switch should not be used on opposite polarities. When load M1 is connected between the contact and line L2, and load M2 is connected between the other contact and line L1 (figure 7), a line-to-line short (bold line) can occur through the arc, which may be drawn as the contacts operate. When contacts are connected to the same polarity (figure 8), this line-to-line short cannot occur.
- The same result can occur if different power sources are connected to the single-pole, double-throw contacts of a snap switch.
- With limit switches having reed contacts, some form of transient protection should be used. This protects the small contacts from damaging surges and increases contact life.

### Coolant

- When possible, avoid mounting limit switches where they will be constantly exposed to coolant, chips, etc. Although designed for such applications, switches last longer when not exposed to these contaminants.
- Make sure cover screws are tightened to ensure a good oiltight seal.
- When possible, avoid using fire-resistant coolants of the phosphate ester type. Equipment exposed to these coolants requires special seals and gaskets. Viton® fluoroelastomer, resistant to these types of coolants, is the standard shaft seal material on Type C lever arm types. If required, all gaskets, as well as boots on plunger types, can be furnished in Viton material.

### Recommendations for Conduit Installation

Limit switch leakage is often traced to the conduit system. Coolant or condensation in the conduit line can enter the switch through the conduit entry. Oil tightness depends on the condition of the conduit connection and seal. Recommendations for installing conduit to position switches are as follows:

- To ensure an oiltight seal, use thread sealant and a conduit seal or a sealing bushing around the conduit fitting. Otherwise, the fitting probably will leak.
- Limit switches should be installed with the conduit end down whenever possible.
- If condensation or moisture is present inside the conduit, a Square D® conduit seal can be inserted into the conduit entry. The conduit fitting can then be connected in the normal manner. Thread sealant and a sealing bushing must still be used.
- Often a junction box fills with coolant and/or condensation, which backs up into the position limit through the conduit. A simple solution is to drill a hole in the bottom of the junction box to allow the liquid to drain out.
- If conduit leakage is severe, pre-wired and potted position limit (Forms Y184• and Y185•) should be used. The switches are pre-wired with either individual wires or multiconductor STOWA cord, and the receptacle is sealed with a potting material.
- The Square D limit switch is available with a pre-wired male plug receptacle. The connector provides an effective oiltight seal when used with the appropriate female connector cord.

# Limit Switches

## 9007C Heavy Duty Industrial

### Technical Information

#### Terminal Identification

European (IEC) contact terminals marking

Single pole	Double pole	
	1 <sup>st</sup> pole	2 <sup>nd</sup> pole
11-12	11-12	21-22
13-14	13-14	23-24
11-12	11-12	21-22
13-14	13-14	23-24

Each terminal is marked with 2 digits: First digit indicates the pole (circuit). The second digit indicates the type of contact:

\_1-\_2 is N.C., \_3-\_4 is N.O.

i.e.: 11-12, 21-22 are N.C. 13-14, 23-24 are N.O.

#### Example of European Terminal Markings:

For switch elements without isolated contacts:

11-12 is the N.C. contact of pole No. 1, 13-14 is the N.O. contact of pole No. 2

For switch elements with isolated contacts:

13-14 is the N.O. contact of pole No. 1, 21-22 is the N.C. contact of pole No. 2

#### Example of US Terminal Markings

Single pole	Double pole	
	1 <sup>st</sup> pole	2 <sup>nd</sup> pole
1-2	1-2	5-6
3-4	3-4	7-8
1-2	1-2	5-6
3-4	3-4	7-8

Each contact terminal is marked with one digit, i.e., 1-2, 3-4, 5-6, 7-8.

#### Example of US Terminal Markings:

For most snap switch elements (isolated contacts not usually on US manufactured switches):

1-2 is the N.C. contact of pole No. 1,

3-4 is the N.O. contact of pole No. 1

5-6 is the N.C. contact of pole No. 2,

7-8 is the N.O. contact of pole No. 2

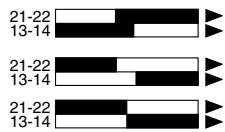

**Make-before-break** (overlapping) SPDT: the normally open contact closes before the normally closed contact opens.

**Break-before-make** (offset) SPDT: the normally closed contact opens before the normally open contact closes.

**Simultaneous make and break** SPDT: the normally closed contact opens at the same time as the normally open contact closes.

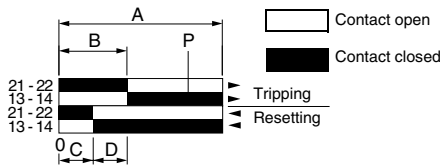

A = Maximum travel of the operator in mm or degrees.

B = Tripping travel of the contact.

C = Resetting travel of contact.

D = B-C = Differential travel.

P = Point from which positive opening is assured.

Note: The arrows indicate direction of actuation clockwise (CW) and return for simplicity reasons. For counterclockwise (CCW) only direction of actuation is reversed.

#### Wiring diagrams

Form A  
SPST-NO



Form B  
SPST-NC



Form C  
SPDT



Form AA  
DPST-NO



Form BB  
DPST-NC



Form CC  
DPDT



Form X  
SPST-NO-DB



Form Y  
SPST-NC-DB



Form Zb  
SPDT isolated contacts

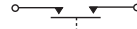

Form Z  
DPDT-DB



Form XX  
DPST-NO-DB



Form YY  
DPST-NC-DB



Form ZZ  
DPDT-DB



# Limit Switches

## 9007C Heavy Duty Industrial Cam Design

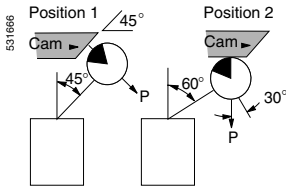

Figure 1A cam design for speeds up to 50 fpm

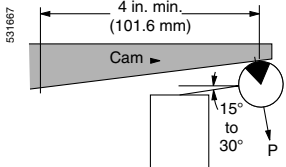

Figure 1B cam design for speeds from 50 to 200 fpm (15.2 to 60.9 mpm).

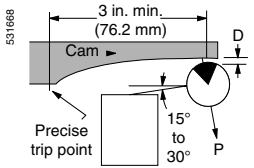

Figure 1C cam design for speeds from 200 to 400 fpm (60.9 to 121.9 mpm).

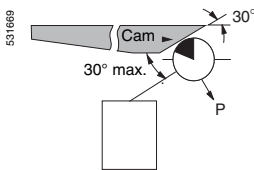

Figure 2

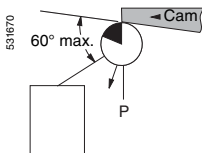

Figure 3

### Application information

Excessive impact from improperly designed actuating systems is without question the leading cause of premature failure of the electromechanical limit switch. At slow speed, impact is rarely troublesome, but as speed increases, impact applied to the switch becomes a critical problem. In today's higher speed machines, therefore, it is important to give proper consideration to correctly designed actuating systems. These recommendations are designed to assist you in obtaining greater life from your limit switches. The black sector in the roller indicates the recommended design limits of the angle of pressure shown in the illustrations as "P". Three main design and installation considerations are:

- The pressure applied by the actuating mechanism to switch operating lever should approximate direction of lever rotation with a variation not to exceed 30°.
- Since the angle of pressure changes drastically with rotation of the lever, the cam must be designed for proper pressure angles at all positions of the lever travel.
- The switch operating levers should be positioned as nearly parallel with the leading edges of the cams as possible.

Considering these three factors:

- The cam in Figure 1A is satisfactory for speeds up to 50 fpm (15.2 mpm)
- The cam in Figure 1B is suitable for speeds up to 200 fpm (60.9 mpm) (nonuniform acceleration of switch lever)
- The cam in Figure 1C is satisfactory for speeds up to 400 fpm (121.9 mpm) (uniform or other controlled acceleration)

### Designing proper pressure angles for overriding cams for electromechanical limit switches

Don't underestimate the importance of adjusting the cams and operating levers in electromechanical limit switches to provide the proper pressure angles in every travel position. Without the means to control the angle of pressure or the limit of override, the operating lever may spring back with damaging results. *Lever flyback usually causes double pulsing of the contacts, and places additional stresses on the mechanical system of the limit switch.* The excessive impacts absorbed from inadequately designed actuating devices eventually leads to abnormal wear and premature failure of the limit switch.

By looking closely at the actuating angles of the cam surface, designers and engineers can obtain the maximum operating life from electromechanical limit switches. The following recommendations help provide a workable knowledge of proper lever and cam angles—and how they are applied to secure optimum conditions:

- Actuating cam on machinery or slide should provide a trailing edge so that upon overriding the operating lever will not snap back.
- During the approach phase, **the pressure angle of the cam should not vary from the lever angle more than 30°.**
- On the override phase, **the angle of the trailing edge of the cam to the lever should be no more than 60°.**

If these guidelines are followed, the switch operating levers will always be approximately parallel with the leading edges of the actuating surfaces or cams.

**Figure 2** shows leading edge of cam about to depress and actuate the electromechanical limit switch. The black sector of the roller indicates the recommended design limits of the angle of pressure shown in drawings as "P".

**Figure 3** shows operating lever roller following the trailing edge of the cam on the override cycle. Unless a one-way lever is used, the cam will operate the switch on the return cycle.

# Limit Switches

## 9007C Heavy Duty Industrial

### Linear/Angular Lever Travel

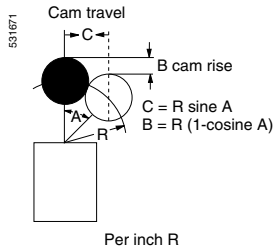

Dual dimensions: in. (mm)

#### Application information (continued)

The table below can assist the designer of machine tools and conveyors, the plant engineer, or the maintenance personnel responsible for keeping this equipment in a satisfactory operating condition.

The design engineer will find the table useful in making trouble-free cam layouts. For example, if the recommended operating travel for a switch is between 15° and 30°, use the table to figure cam rise and travel. This aids in determining what type of cam to design, its dimensions, etc.

The plant engineer can use the table to determine where to position levers on replacement switches or revamped circuitry to operate existing cams. The engineer can also use the table to position the lever in proper relationship to the cam, and to find out whether switches and cams are installed properly to obtain maximum switch life.

**All dimensions in the table are for 1 in. (25.4 mm) levers. If you use longer levers, multiply the figures by the increased lever length. For example, for a 2 in. (50.8 mm) lever, use the multiplier 2.**

**All limit switches have a recommended operating travel and for best performance should be installed within these limits. (1)**

A	B	C	A	B	C
1°	0.0002 (0.005mm)	0.017 (0.43mm)	46°	0.305 (7.7mm)	0.719 (18.2mm)
2°	0.0006 (0.015mm)	0.035 (0.89mm)	47°	0.318 (8.1mm)	0.731 (18.6mm)
3°	0.0014 (0.035mm)	0.052 (1.3mm)	48°	0.331 (8.4mm)	0.743 (18.9mm)
4°	0.002 (0.05mm)	0.070 (1.8mm)	49°	0.344 (8.7mm)	0.755 (19.2mm)
5°	0.004 (0.101mm)	0.087 (2.2mm)	50°	0.357 (9.0mm)	0.766 (19.4mm)
6°	0.005 (0.127mm)	0.105 (2.6mm)	51°	0.371 (9.4mm)	0.777 (19.7mm)
7°	0.007 (0.178mm)	0.122 (3.1mm)	52°	0.384 (9.7mm)	0.788 (20.0mm)
8°	0.010 (0.254mm)	0.139 (3.5mm)	53°	0.398 (10.1mm)	0.799 (20.3mm)
9°	0.012 (0.304mm)	0.156 (4.0mm)	54°	0.412 (10.4mm)	0.809 (20.5mm)
10°	0.015 (0.381mm)	0.174 (4.4mm)	55°	0.426 (11.0mm)	0.819 (20.8mm)
11°	0.018 (0.457mm)	0.191 (4.8mm)	56°	0.441 (11.2mm)	0.829 (21.0mm)
12°	0.022 (0.559mm)	0.208 (5.3mm)	57°	0.455 (11.5mm)	0.839 (21.3mm)
13°	0.026 (0.660mm)	0.225 (5.7mm)	58°	0.485 (12.3mm)	0.857 (21.7mm)
14°	0.030 (0.762mm)	0.242 (6.1mm)	59°	0.485 (12.3mm)	0.857 (21.7mm)
15°	0.034 (0.863mm)	0.259 (6.6mm)	60°	0.500 (12.7mm)	0.866 (22mm)
16°	0.039 (0.990mm)	0.276 (7.2mm)	61°	0.515 (13.1mm)	0.875 (22.2mm)
17°	0.044 (1.12mm)	0.292 (7.4mm)	62°	0.531 (13.5mm)	0.883 (22.5mm)
18°	0.049 (1.24mm)	0.309 (7.8mm)	63°	0.546 (14.0mm)	0.891 (22.6mm)
19°	0.054 (1.37mm)	0.326 (8.3mm)	64°	0.562 (14.3mm)	0.899 (22.8mm)
20°	0.060 (1.52mm)	0.342 (8.7mm)	65°	0.577 (14.6mm)	0.906 (23.0mm)
21°	0.066 (1.67mm)	0.358 (9.1mm)	66°	0.593 15.0(mm)	0.914 (23.2mm)
22°	0.073 (1.85mm)	0.375 (9.5mm)	67°	0.609 15.5(mm)	0.921 (23.4mm)
23°	0.079 (2.00mm)	0.391 (9.9mm)	68°	0.625 (16.0mm)	0.927 (23.5mm)
24°	0.086 (2.2mm)	0.407 (10.3mm)	69°	0.642 (16.3mm)	0.934 (23.7mm)
25°	0.094 (2.38mm)	0.423 (10.7mm)	70°	0.658 (16.7mm)	0.940 (23.9mm)
26°	0.101 (2.56mm)	0.438 (11.1mm)	71°	0.674 (17.1mm)	0.946 (24.0mm)
27°	0.109 (2.77mm)	0.454 (11.5mm)	72°	0.691 (17.5mm)	0.951 (24.1mm)
28°	0.117 (2.9mm)	0.469 (12mm)	73°	0.708 (18.0mm)	0.956 (24.3mm)
29°	0.125 (3.17mm)	0.485 (12.3mm)	74°	0.724 (18.4mm)	0.961 (24.4mm)
30°	0.134 (3.40mm)	0.500 (12.7mm)	75°	0.741 (19.0mm)	0.966 (24.5mm)
31°	0.143 (3.6mm)	0.515 (13.1mm)	76°	0.758 (19.2mm)	0.970 (24.6mm)
32°	0.152 (3.9mm)	0.530 (13.4mm)	77°	0.775 (20.0mm)	0.974 (24.7mm)
33°	0.161 (4.1mm)	0.545 (14.0mm)	78°	0.792 (20.1mm)	0.978 (24.8mm)
34°	0.171 (4.3mm)	0.559 (14.2mm)	79°	0.809 (20.5mm)	0.982 (24.9mm)
35°	0.181 (4.6mm)	0.574 (14.6mm)	80°	0.826 (21.0mm)	0.985 (25.0mm)
36°	0.191 (4.8mm)	0.588 (15mm)	81°	0.844 (21.4mm)	0.988 (25.1mm)
37°	0.201 (5.1mm)	0.602 (15.3mm)	82°	0.861 (21.8mm)	0.990 (25.1mm)
38°	0.212 (5.4mm)	0.616 (15.6mm)	83°	0.878 (22.3mm)	0.993 (25.2mm)
39°	0.223 (5.7mm)	0.629 (16.0mm)	84°	0.895 (22.7mm)	0.995 (25.3mm)
40°	0.234 (6.0mm)	0.643 (16.3mm)	85°	0.913 (23.2mm)	0.996 (25.3mm)
41°	0.245 (6.2mm)	0.656 (16.6mm)	86°	0.930 (23.6mm)	0.9976 (25.3mm)
42°	0.257 (6.5mm)	0.669 (17.0mm)	87°	0.948 (24.0mm)	0.9986 (25.4mm)
43°	0.269 (6.8mm)	0.682 (17.3mm)	88°	0.965 (24.5mm)	0.9994 (25.4mm)
44°	0.281 (7.1mm)	0.695 (17.6mm)	89°	0.983 (25.0mm)	0.9999 (25.4mm)
45°	0.293 (7.4mm)	0.707 (18mm)	90°	1.000 (25.4mm)	1.000 (25.4mm)

(1) Refer to document SM444R1 for additional information regarding Cam speed and angles.

# Limit Switches

## 9007C Heavy Duty Industrial

### Installation Considerations

#### Lever Actuators

For limit switches with lever actuators, the actuating force should be applied as nearly perpendicular to the lever as practical and perpendicular to the shaft axis about which the lever rotates.

#### Lever Actuators

Correct

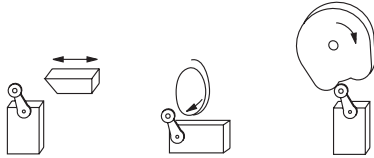

Incorrect

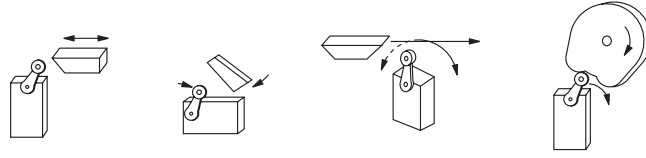

#### Dwelling Requirements

Where relatively fast motions are involved, the cams should be so designed that the limit switch will be held operated long enough to operate relays, valves, etc.

Correct

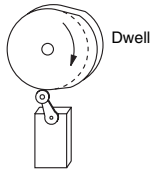

Incorrect

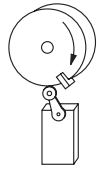

#### Overtravel limitations

Operating mechanisms for limit switches should be so designed that, under any operating or emergency conditions, the limit switch is not operated beyond its overtravel limit position. A limit switch should not be used as a mechanical stop.

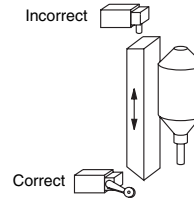
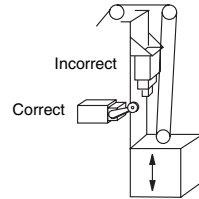

Correct

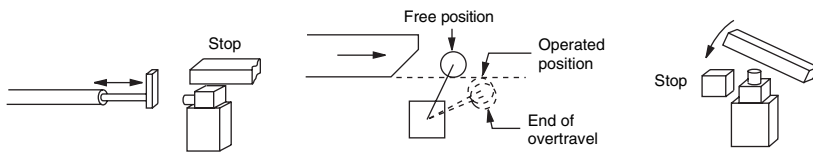

# Limit Switches

## 9007T and FT Severe Duty Mill and Foundry Switches

### Conforming to NEMA A600 and UL508

#### Description

##### 9007T Mill Switches

Use the 9007T Mill switches instead of other limit switches in the following applications:

- 1 Where the current load exceeds the typical heavy duty limit switch contact rating of 10 A and falls within the range of up to 20 A continuous.
- 2 Where an operating sequence is required that is not possible on other limit switches. Fifteen sequences are available. Universal type has twelve different operating sequences with CW only, CCW only and neutral position. Standard type has three operating sequences with CW and CCW operation.
- 3 Where higher reset forces are required due to foreign material interfering with lever arm operation, or where long heavy arms must reset against gravity.

##### 9007FT Foundry Switches

The 9007FT Foundry switches are for use in foundries or mills where the applications described above are required, and where falling foundry sand or similar material could build up and jam the operating mechanism. The shaft has a dust boot and extends from the switch case, preventing sand build up around the shaft. The devices can withstand hot falling sand up to 300° F (149° C.).

#### 9007 (convertible sequence)

##### 9007T Mill Switches

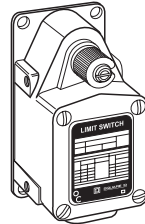

Page 212

##### 9007FT Foundry Switches

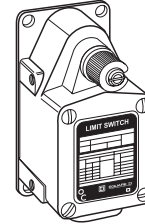

Page 214

#### Application Information

**Type T** — Ideal for applications requiring extra heavy duty contact ratings, or higher operating and reset forces. Rugged mechanical construction with several different operating sequences in one basic switch.

**Type FT** — Designed specifically for rough foundry application. The shaft is entirely beyond the switch case to prevent jamming of the lever arm due to build up of sand. A dust boot is furnished as standard to further prevent sand packing and allow free movement of the lever arm. An extra long shaft bearing makes the switch extremely rugged and able to handle the rough applications encountered in foundries, mills, machine tool and similar industries. The switch will withstand hot falling sand up to 300° F (149° C).

#### Type T and FT

**Enclosure** — Oil-tight, dust-tight, water-tight, drip-tight meets NEMA Types 2, 4, and 13 requirements. Die cast zinc construction.

**Operating Sequences** — Fifteen sequences available. Universal type has 12 different operating sequences with CW only, CCW only, and neutral position operation. Standard type has three operating sequences with CW and CCW operation. Various sequences will give quick make and break, spring return with maintained contact, or slow make and break. Most sequences are convertible by removing the base plate and adjusting the positioning plate and/or latches

**Ambient Temperature Range** — 10° F (-12.2° C) to 185° F (85° C) ambient at full rated load, up to 220° F (104° C) ambient with single coil load.

**Lever Arm** — Die cast zinc construction with hardened, oil-impregnated, sintered iron rollers.

**Conduit** — 0.5" standard / 20 mm optional—Form M11

**Mounting** — Four baseplates provide end or side mounting holes and/or manifold mounting. All mounting holes are 0.25" (6.35 mm) diameter. Two tapped holes on each side of switch allows side mounting.

**Contacts** — SPDT<sup>1</sup> double break and three point double throw single break. Silver contact tips. Phenolic contact block. Nylon liner. Polarity must be the same on double throw contacts.

1. Single pole, double throw.

Interpretation of Catalog Numbers:  
page 235

# Limit Switches

## 9007T and FT Severe Duty Mill and Foundry Switches

### Conforming to NEMA A600 and UL508

Environment characteristics	
Conforming to standards	UL508
Product certifications	UL Listed, CSA Certified, CE Marked
Protective treatment	Corrosion resistant gray paint
Ambient air temperature	-10 to +185 °F (-23 to +85 °C) Housing can withstand falling sand at +300 °F (+149 °C)
Vibration resistance	10G (10–55 Hz)
Shock resistance	30G
Electric shock protection	Class O
Degree of protection	NEMA Types 1, 2, 4, 12, 13, IP65, 66, 67
Cable entry or connector	0.5" NPT (metric available)
Materials	Cast zinc $\varnothing$

Contact block characteristics		
Rated operational characteristics hard contacts	AC Voltage	NEMA A600 Ithe = 20 A 20 A Resistive and continuous
Rated operational characteristics hard contacts	DC Voltage	NEMA P 600 Ithe = 20 A 20 A Resistive and continuous
Rated insulation voltage		600 V
Rated impulse withstand voltage		2,500 Vac for 1 minute for CE, 2,200 Vac for 1 minute for UL, and 2,640 Vac for 1 minute for CSA
Positive opening		No
Short circuit protection		20 A Bussmann Class CC KTK-R-20 fuse, non-time-delay
Terminal wire sizes (Cabling/Screw Clamp)		12 – 22 AWG (3.31 mm <sup>2</sup> – 0.326 mm <sup>2</sup> ) wire max.
Maximum actuation speed		15.2 mpm / 27.4 mpm (50 fpm / 90 fpm) with 45° Cam angle, levers only

Maximum current ratings for control circuit contacts												
Contacts	Volts	AC						Volts	DC			
		Inductive 35% Power Factor		Continuous Carrying Amperes	Resistive 75% Power Factor		Inductive and Resistive		Continuous Carrying Amperes			
		Make Amperes	Break VA		Make, Break and Continuous Carrying Amperes	Single Throw				Double Throw		
SPDT Quick Make and Break	120	150	18,000	20	2400	20	20	120	5.0	$\varnothing$	20	
	240	75	18,000	12.5	3000	20	20	250	1.0	$\varnothing$	20	
	480	37.5	18,000	6.25	3000	20	20	600	0.2	$\varnothing$	20	
	600	30	18,000	5	3000	20	20					
All Slow Make and Break	120	60	7200	6	720	20	10	20	$\varnothing$	$\varnothing$	$\varnothing$	$\varnothing$
	240	30	7200	3	720	20	10	20	$\varnothing$	$\varnothing$	$\varnothing$	$\varnothing$
	480	15	7200	1.5	720	20	10	20	$\varnothing$	$\varnothing$	$\varnothing$	$\varnothing$
	600	12	7200	1.2	720	20	10	20	$\varnothing$	$\varnothing$	$\varnothing$	$\varnothing$

Characteristics for material and ratings comparisons — standard switches $\varnothing$		
	9007 Type T/FT	Type L (R. B. Denison Lox Switch)
Body material	Cast zinc	Cast aluminum
Cover material	Cast zinc	Aluminum
Base plate material	Steel with zinc plating	Steel with chromate plating
Shaft seal material	Nitrile	PVC
Contact block material	Phenolic	Glass filled nylon
Moveable contact material	Fine silver on copper backing	Coin Silver on steel backing
Stationary contact material	Fine silver on copper backing	90/10 AgCdO on copper backing
Low ambient temperature rating	-10° F	0° F
High ambient temperature at full rating $\blacklozenge$	180° F	200° F
Enclosure rating	NEMA Types 1, 2, 4, 12 and 13	NEMA Types 1, 4 and 13
Vibration resistance	10G (10–150 Hz)	40G max (10-150 Hz)

$\blacklozenge$  Many switches are available with higher or lower temperature limits by selecting special versions or special options. See page 233.



# Limit Switches

## 9007T Severe Duty Mill Switches

### Universal Operating Sequences

#### Universal Catalog Numbers

##### Base Plate

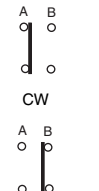
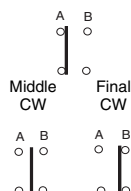
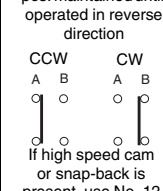
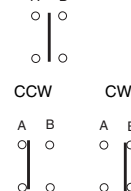
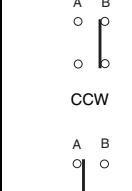
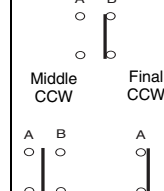





Surface Mounted	A	9007TUA1	9007TUA2	9007TUA3	9007TUA4	9007TUA5	9007TUA6
	B	9007TUB1	9007TUB2	9007TUB3	9007TUB4	9007TUB5	9007TUB6
	C	9007TUC1	9007TUC2	9007TUC3	9007TUC4	9007TUC5	9007TUC6
	D	9007TUD1	9007TUD2	9007TUD3	9007TUD4	9007TUD5	9007TUD6
		No. 1	No. 2	No. 3 ④	No. 4	No. 5	No. 6
		SPDT Spring Return CW Only	SPDT Spring Return CW Only	SPDT Maintained Contact	SPDT Spring Return Neutral Position	SPDT Spring Return CCW Only	SPDT Spring Return CCW Only
		Initial position and CCW 	Initial position and CCW 	Spring return of arm to initial pos. Contact pos. maintained until operated in reverse direction CCW CW 	Initial position 	Initial position and CW 	Initial position and CW 

#### Characteristics

##### Nominal Operating Data

Pre-travel ①	14°	Int. Pos. 9°, Final 16°	7°	6°	14°	Int. Pos. 9°, Final 16°
Total travel	88°	88°	81°	81°	88°	88°
Differential	12°	5°	7°	5°	12°	5°
Operating torque	12 lb-in (1.35 N•m)	12 lb-in (1.35 N•m)	12 lb-in (1.35 N•m)	12 lb-in (1.35 N•m)	12 lb-in (1.35 N•m)	12 lb-in (1.35 N•m)
Repeat accuracy ②	± 0.004" (0.10mm)	± 0.004" (0.10mm)	± 0.004" (0.10mm)	± 0.004" (0.10mm)	± 0.004" (0.10mm)	± 0.004" (0.10mm)

To convert sequences, remove base plate, position plate and latches. Reassemble positioning plate and latches as shown.

						
Weight lb (kg)	2.35 lb. (1.07 kg)	2.35 lb. (1.07 kg)	2.35 lb. (1.07 kg)	2.35 lb. (1.07 kg)	2.35 lb. (1.07 kg)	2.35 lb. (1.07 kg)

#### Universal Catalog Numbers (continued)

##### Base Plate

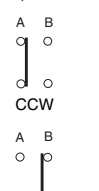
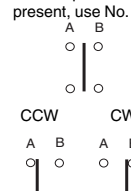
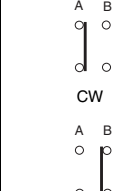
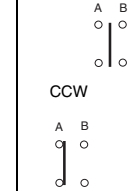
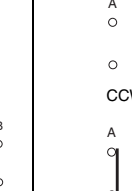
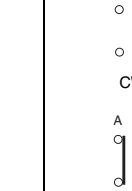



Surface Mounted	A	9007TUA7	9007TUA8	9007TUA9	9007TUA10	9007TUA11	9007TUA12
	B	9007TUB7	9007TUB8	9007TUB9	9007TUB10	9007TUB11	9007TUB12
	C	9007TUC7	9007TUC8	9007TUC9	9007TUC10	9007TUC11	9007TUC12
	D	9007TUD7	9007TUD8	9007TUD9	9007TUD10	9007TUD11	9007TUD12
		No. 7	No. 8 ④	No. 9	No. 10	No. 11	No. 12
		SPDT Maintained	SPDT Maintained Neutral Position	SPDT Spring Return Slow Make, Slow Break	SPDT Spring Return Slow Make, Slow Break	SPDT Spring Return Slow Mak, Slow Break	SPDT Maintained
		If high speed cam or snap-back present, use No. 12 	Initial position If high speed cam or snap-back is present, use No. 12 	Initial position and CCW 	Initial position 	Initial position and CW 	CCW 

#### Characteristics

##### Nominal Operating Data

Pre-travel ①	10°	6°	12°	3°	12°	45°
Total travel	85°	81°	87°	81°	87°	90°
Differential	12°	10°	0°	0°	0°	0°
Operating torque	2.5 lb-in (0.28 N•m)	2.5 lb-in (0.28 N•m)	12 lb-in (1.35 N•m)	12 lb-in (1.35 N•m)	12 lb-in (1.35 N•m)	8 lb-in (0.9 N•m)
Repeat accuracy ②	± 0.004" (0.10mm)	± 0.004" (0.10mm)	± 0.004" (0.10mm)	± 0.004" (0.10mm)	± 0.004" (0.10mm)	± 0.004" (0.10mm)

To convert sequences, remove base plate, position plate and latches. Reassemble positioning plate and latches as shown.

						Not adjustable
Weight lb (kg)	2.35 lb (1.07 kg)	2.35 lb. (1.07 kg)	2.35 lb. (1.07 kg)	2.35 lb. (1.07 kg)	2.35 lb. (1.07 kg)	2.35 lb. (1.07 kg)

Footnotes: see page 213

Dimensions:  
pages 218 to 221

Interpretation of Catalog Numbers:  
page 235

Base Plates:  
pages 217 and 218



# Limit Switches

## 9007T Severe Duty Mill Switches

### Standard Operating Sequences

#### Standard Catalog Numbers

Base Plate

Surface Mounted

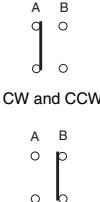
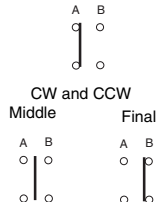
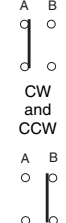

A	9007TSA1	9007TSA2	9007TSA3
B	9007TSB1	9007TSB2	9007TSB3
C	9007TSC1	9007TSC2	9007TSC3
D	9007TSD1	9007TSD2	9007TSD3
	<b>No. 1</b>	<b>No. 2</b>	<b>No. 3</b>
	SPDT Spring Return CW & CCW	SPDT Spring Return CW & CCW	SPDT Spring Return CW & CCW Slow Make, Slow Break
	Initial position 	Initial position 	Initial position 

#### Characteristics (nominal operating data)

Switch actuation	By 30° cam		
Type of actuation			
Pre-travel ①	14°	Int. Pos. 9°, Final 16°	9°
Total travel	89°	89°	89°
Differential	12°	Int. Pos. 5.5°, Final 7.5°	5°
Reverse overtravel	N/A (future availability)	N/A (future availability)	N/A (future availability)
Operating torque/force 1 pole & 2 pole	10 lb-in (1.13 N•m)	10 lb-in (1.13 N•m)	10 lb-in (1.13 N•m)
Terminal wire sizes (Cabling/Screw Clamp)	#12–22 AWG (3.31–0.326 mm <sup>2</sup> )	#12–22 AWG (3.31–0.326 mm <sup>2</sup> )	#12–22 AWG (3.31–0.326 mm <sup>2</sup> )
Repeatability ② (linear travel of cam)	± 0.004" (0.10 mm)	± 0.004" (0.10 mm)	± 0.004" (0.10 mm)
Cable entry (metric available)	0.5" NPT	0.5" NPT	0.5" NPT
Weight lb (kg)	2.35 lb. (1.07 kg)	2.35 lb. (1.07 kg)	2.35 lb. (1.07 kg)

① The pre-travel listed may vary up to 5° additional for universal switches or up to 2° additional for standard switches due to free travel of lever arm at initial position.

② Linear travel of cam on 1.5" (38.1mm) lever arm.

③ Remove spring from the positioning plate.

④ Sequence 3, 7, and 8 devices are available but are not recommended where high speed cams or lever arm snap-back is present. The application should be checked and No. 12 sequences substituted where possible.

**Note:** For Type FT foundry switches, change the "T" at the beginning of the equivalent Type number above to "FT" (Example: FTUB1). See page 214.

# Limit Switches

## 9007FT Severe Duty Foundry Switches

### Universal Operating Sequences

#### Universal Catalog Numbers

Base Plate

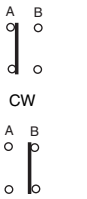
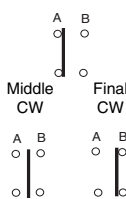
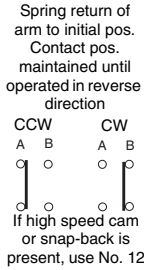
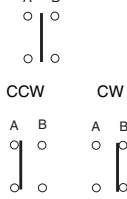
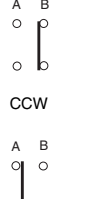
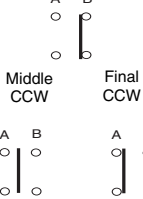





Surface Mounted	A	9007FTUA1	9007FTUA2	9007FTUA3	9007FTUA4	9007FTUA5	9007FTUA6
	B	9007FTUB1	9007FTUB2	9007FTUB3	9007FTUB4	9007FTUB5	9007FTUB6
C	9007FTUC1	9007FTUC2	9007FTUC3	9007FTUC4	9007FTUC5	9007FTUC6	9007FTUC6
D	9007FTUD1	9007FTUD2	9007FTUD3	9007FTUD4	9007FTUD5	9007FTUD6	9007FTUD6
	<b>No. 1</b>	<b>No. 2</b>	<b>No. 3</b> ④	<b>No. 4</b>	<b>No. 5</b>	<b>No. 6</b>	
	SPDT Spring Return CW Only	SPDT Spring Return CW Only	SPDT Maintained Contact	SPDT Spring Return Neutral Position	SPDT Spring Return CCW Only	SPDT Spring Return CCW Only	
	Initial position and CCW 	Initial position and CCW 	Spring return of arm to initial pos. Contact pos. maintained until operated in reverse direction CCW CW 	Initial position 	Initial position and CW 	Initial position and CW 	

#### Characteristics

##### Nominal Operating Data

Pre-travel ①	14°	Int. Pos. 9°, Final 16°	7°	6°	14°	Int. Pos. 9°, Final 16°
Total travel	88°	88°	81°	81°	88°	88°
Differential	12°	5°	7°	5°	12°	5°
Operating torque	12 lb-in (1.35 N•m)	12 lb-in (1.35 N•m)	12 lb-in (1.35 N•m)	12 lb-in (1.35 N•m)	12 lb-in (1.35 N•m)	12 lb-in (1.35 N•m)
Repeat accuracy ②	± 0.004" (0.10mm)	± 0.004" (0.10mm)	± 0.004" (0.10mm)	± 0.004" (0.10mm)	± 0.004" (0.10mm)	± 0.004" (0.10mm)

To convert sequences, remove base plate, position plate and latches. Reassemble positioning plate and latches as shown.

						
Weight lb (kg)	2.57 lb (1.17 kg)	2.57 lb (1.17 kg)	2.57 lb (1.17 kg)	2.57 lb (1.17 kg)	2.57 lb (1.17 kg)	2.57 lb (1.17 kg)

#### Universal Catalog Numbers (continued)

Base Plate

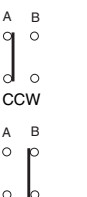
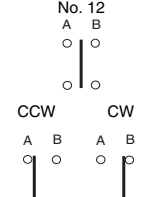
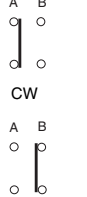
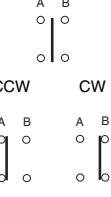
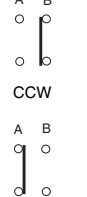
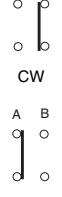



Surface Mounted	A	9007FTUA7	9007FTUA8	9007FTUA9	9007FTUA10	9007FTUA11	9007FTUA12
	B	9007FTUB7	9007FTUB8	9007FTUB9	9007FTUB10	9007FTUB11	9007FTUB12
C	9007FTUC7	9007FTUC8	9007FTUC9	9007FTUC10	9007FTUC11	9007FTUC12	9007FTUC12
D	9007FTUD7	9007FTUD8	9007FTUD9	9007FTUD10	9007FTUD11	9007FTUD12	9007FTUD12
	<b>No. 7</b>	<b>No. 8</b> ④	<b>No. 9</b>	<b>No. 10</b>	<b>No. 11</b>	<b>No. 12</b>	
	SPDT Maintained	SPDT Maintained Neutral Position	SPDT Spring Return Slow Make, Slow Break	SPDT Spring Return Slow Make, Slow Break	SPDT Spring Return Slow Make, Slow Break	SPDT Maintained	
	If high speed cam or snap-back present, use No. 12 	Initial position If high speed cam or snap-back present, use No. 12 	Initial position and CCW 	Initial position 	Initial position and CW 	CCW 	

#### Characteristics

##### Nominal Operating Data

Pre-travel ①	10°	6°	12°	3°	12°	45°
Total travel	85°	81°	87°	81°	87°	90°
Differential	12°	10°	0°	0°	0°	0°
Operating torque	2.5 lb-in (0.28 N•m)	2.5 lb-in (0.28 N•m)	12 lb-in (1.35 N•m)	12 lb-in (1.35 N•m)	12 lb-in (1.35 N•m)	8 lb-in (0.9 N•m)
Repeat accuracy ②	± 0.004" (0.10mm)	± 0.004" (0.10mm)	± 0.004" (0.10mm)	± 0.004" (0.10mm)	± 0.004" (0.10mm)	± 0.004" (0.10mm)

To convert sequences, remove base plate, position plate and latches. Reassemble positioning plate and latches as shown.

						Not adjustable
Weight lb (kg)	2.57 lb (1.17 kg)	2.57 lb (1.17 kg)	2.57 lb (1.17 kg)	2.57 lb (1.17 kg)	2.57 lb (1.17 kg)	2.57 lb (1.17 kg)

Footnotes: see page 215

Dimensions:  
pages 218 to 221

Interpretation of Catalog Numbers:  
page 235

# Limit Switches

## 9007FT Severe Duty Foundry Switches

### Standard Operating Sequences

#### Standard Catalog Numbers

Base Plate

Surface  
Mounted



A	9007FTSA1	9007FTSA2	9007FTSA3
B	9007FTSB1	9007FTSB2	9007FTSB3
C	9007FTSC1	9007FTSC2	9007FTSC3
D	9007FTSD1	9007FTSD2	9007FTSD3
	<b>No. 1</b>	<b>No. 2</b>	<b>No. 3</b>
	Single Pole Double Throw Spring Return CW & CCW	Single Pole Double Throw Spring Return CW & CCW	Single Pole Double Throw Spring Return CW & CCW Slow Make Slow Break
	Initial position  CW and CCW	Initial position  CW and CCW	Initial position  CW and CCW

#### Characteristics (nominal operating data)

Switch actuation	By 30° cam		
Type of actuation			
Pre-travel ①	14°	Int. Pos. 9°, Final 16°	9°
Total travel	89°	89°	89°
Differential	12°	Int. Pos. 5.5°, Final 7.5°	5°
Reverse overtravel	N/A (future availability)	N/A (future availability)	N/A (future availability)
Operating torque/force 1 pole & 2 pole	10 lb-in (1.13 N•m)	10 lb-in (1.13 N•m)	10 lb-in (1.13 N•m)
Terminal wire sizes (Cabling/Screw Clamp)	#12–22 AWG (3.31–0.326 mm <sup>2</sup> )	#12–22 AWG (3.31–0.326 mm <sup>2</sup> )	#12–22 AWG (3.31–0.326 mm <sup>2</sup> )
Repeatability ② (linear travel of cam)	± 0.004" (0.10mm)	± 0.004" (0.10mm)	± 0.004" (0.10mm)
Cable entry (metric available)	0.5" NPT	0.5" NPT	0.5" NPT
Weight lb (kg)	2.57 lb. (1.17 kg)	2.57 lb. (1.17 kg)	2.57 lb. (1.17 kg)

① The pre-travel listed may vary up to 5° additional for universal switches or up to 2° additional for standard switches due to free travel of lever arm at initial position.

② Linear travel of cam on 1.5" (38.1mm) lever arm.

③ Remove spring from the positioning plate.

④ Sequence 3, 7, and 8 devices are available but are not recommended where high speed cams or lever arm snap-back is present.

The application should be checked and No. 12 sequences substituted where possible.

Note: Type FT Foundry Switches are obtained by changing the "T" at the beginning of the equivalent type number to "FT" (Example: FTUB1).

# Limit Switches

## 9007T and FT Severe Duty Mill and Foundry Switches

### Lever Arms and Renewal Parts



Standard Roller

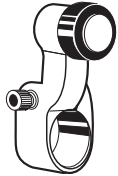

Offset Type

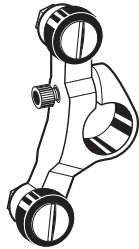

120° Forked

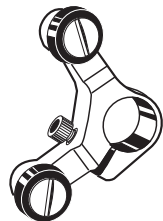

90° Forked

Standard Roller					
Arm	Steel Roller			Catalog Number	Weight lb (kg)
Length in. (mm)	Diameter in. (mm)	Roller Position	Width in. (mm)		
1.5 (38.1)	0.75 (19)	Optional	0.25 (6.3)	9007B1	0.17 (0.077)
1.5 (38.1)	1.0 (25.4)	Optional	0.25 (6.3)	9007B2	0.19 (0.086)
1.5 (38.1)	1.38 (35)	Optional	0.25 (6.3)	9007B3	0.23 (0.104)
2.5 (63.5)	0.75 (19)	Optional	0.25 (6.3)	9007B7	0.25 (0.113)
2.5 (63.5)	1.0 (25.4)	Optional	0.25 (6.3)	9007B8	0.25 (0.113)
2.5 (63.5)	1.38 (35)	Optional	0.25 (6.3)	9007B9	0.27 (0.122)
1.5 (38.1)	0.75 (19)	Optional	0.5 (12.7)	9007B12	0.34 (0.154)
1.5 (38.1)	1.0 (25.4)	Optional	0.5 (12.7)	9007B13	0.34 (0.154)
1.5 (38.1)	1.38 (35)	Optional	0.5 (12.7)	9007B14	0.42 (0.191)
5 (127)	0.75 (19)	Optional	0.25 (6.3)	9007B19	1.00 (0.454)
2.88 (73.1)	0.75 (19)	No roller	—	9007B21	0.20 (0.091)
2.5 (63.5)	0.75 (19)	Optional	0.5 (12.7)	9007B22	0.22 (0.100)
2.5 (63.5)	1.0 (25.4)	Optional	0.5 (12.7)	9007B23	0.28 (0.127)
2.5 (63.5)	1.38 (35)	Optional	0.5 (12.7)	9007B24	0.36 (0.163)
Adjustable <sup>(1)</sup>	0.75 (19)	Optional	0.25 (6.3)	9007R18	0.50 (0.227)
Adjustable <sup>(1)</sup>	1.0 (25.4)	Optional	0.25 (6.3)	9007R19	0.50 (0.227)
Adjustable <sup>(1)</sup>	1.38 (35)	Optional	0.25 (6.3)	9007R20	0.50 (0.227)

1. Does not include lever arm clamp or rod. If lever arm clamp is required, use 9007R16 or R17.

Offset Type (used to obtain different cam track dimensions)					
Arm	Steel Roller			Catalog Number	Weight lb (kg)
Length in. (mm)	Diameter in. (mm)	Roller Position	Width in. (mm)		
1.5 (38.1)	0.75 (19)	Inside offset	0.25 (6.3)	9007C1	0.50 (0.227)
1.5 (38.1)	1.0 (25.4)	Inside offset	0.25 (6.3)	9007C2	0.50 (0.227)
1.5 (38.1)	1.38 (35)	Inside offset	0.25 (6.3)	9007C3	0.50 (0.227)
1.5 (38.1)	0.75 (19)	Outside offset	0.25 (6.3)	9007D1	0.18 (0.082)
1.5 (38.1)	1.0 (25.4)	Outside offset	0.25 (6.3)	9007D2	0.18 (0.082)
1.5 (38.1)	1.38 (35)	Outside offset	0.25 (6.3)	9007D3	0.18 (0.082)
1.88 (48)	0.75 (19)	Outside offset	0.25 (6.3)	9007E4	0.20 (0.091)
1.88 (48)	1.0 (25.4)	Outside offset	0.25 (6.3)	9007E5	0.27 (0.122)
1.88 (48)	1.38 (35)	Outside offset	0.25 (6.3)	9007E6	0.27 (0.122)
1.88 (48)	0.75 (19)	Inside offset	0.25 (6.3)	9007F4	0.30 (0.136)
1.88 (48)	1.0 (25.4)	Inside offset	0.25 (6.3)	9007F5	0.30 (0.136)
1.88 (48)	1.38 (35)	Inside offset	0.25 (6.3)	9007F6	0.30 (0.136)

120° Forked (used with maintained contact lever arm type switches)					
Arm	Steel Roller			Catalog Number	Weight lb (kg)
Length in. (mm)	Diameter in. (mm)	Roller Position	Width in. (mm)		
1.5 (38.1)	0.75 (19)	Same side	0.25 (6.3)	9007J1	0.31 (0.141)
1.5 (38.1)	1.0 (25.4)	Same side	0.25 (6.3)	9007J2	0.40 (0.181)
1.5 (38.1)	0.75 (19)	LH on opp. side	0.25 (6.3)	9007K1	0.50 (0.227)
1.5 (38.1)	1.0 (25.4)	LH on opp. side	0.25 (6.3)	9007K2	0.50 (0.227)
1.5 (38.1)	0.75 (19)	RH on opp. side	0.25 (6.3)	9007N1	0.66 (0.299)
1.5 (38.1)	1.0 (25.4)	RH on opp. side	0.25 (6.3)	9007N2	0.70 (0.316)

90° Forked (used with maintained contact lever arm type switches)					
Arm	Steel Roller			Catalog Number	Weight lb (kg)
Length in. (mm)	Diameter in. (mm)	Roller Position	Width in. (mm)		
1.5 (38.1)	0.75 (19)	Same side	0.25 (6.3)	9007X1	0.30 (0.136)
1.5 (38.1)	1.0 (25.4)	Same side	0.25 (6.3)	9007X2	0.40 (0.181)
1.5 (38.1)	0.75 (19)	RH on opp. side	0.25 (6.3)	9007Y1	0.50 (0.227)
1.5 (38.1)	1.0 (25.4)	RH on opp. side	0.25 (6.3)	9007Y2	0.50 (0.227)
1.5 (38.1)	0.75 (19)	LH on opp. side	0.25 (6.3)	9007Z1	0.66 (0.299)
1.5 (38.1)	1.0 (25.4)	LH on opp. side	0.25 (6.3)	9007Z2	0.70 (0.316)

Dimensions:  
pages 218 to 221

# Limit Switches

## 9007T and FT Severe Duty Mill and Foundry Switches

### Lever Arms and Renewal Parts

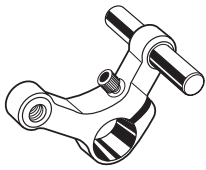

With Reset

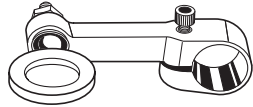

Cable Operated

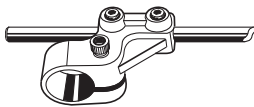

Rod Type  
(rod not included)



Ball Bearing Type



Weld-On Type

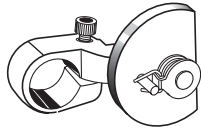

1-Way Roller Type

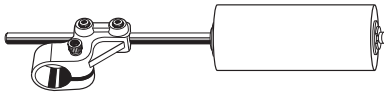

Conveyor Side Guide  
(use with 9007R16 or R17)

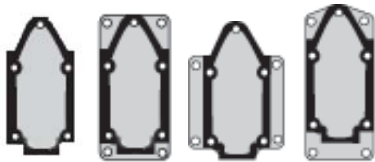

Style A    Style B    Style C    Style D

Base Plates

Cable operated					
Arm Length in. (mm)	Steel roller Diameter in. (mm)	Roller Roller Position	Width in. (mm)	Catalog Number	Weight lb (kg)
1.5 (38.1)	0.75 (19)	None	None	9007Y3	-
2.5" (63.5mm) long with eyebolt 0.25 (6.3mm) I.D. instead of roller.				9007B27	-
Rod Type (used on conveyor systems or where unusual shapes are required)					
Adjustable	0.75 (19)	0.19 (4.8)	None	9007R16	0.18 (0.081)
Adjustable	0.75 (19)	0.25 (6.3)	None	9007R17	0.18 (0.081)
1. Rod not included 2. Key stock not included					
Ball Bearing Type (for abrasive dust areas or with high speed cams)					
1.5 (38.1)	0.75 (19)	Center	0.28 (7.1)	9007B16	0.15 (0.068)
Weld-On Type (used where a special operator is required to weld to lever)					
3.5 (89)	0.75 (19)	None	None	9007G10	0.50 (0.227)
One Way Roller Type (used with reversible cams for one way operations)					
1.5 (38.1)	0.75 (19)	Outside offset	0.25 (6.3)	9007D4	0.64 (0.290)
Conveyor Side Guide					
8.44" (214.3) long with 1.5" (38.1) dia. 3.75" (95.2) Delrin® roller				9007R21	1.63 (0.739)
8.44" (214.3) long with 0.88" (22.3) dia. 3.75" (95.2) Delrin roller				9007R22	1.42 (0.644)

Separate Base Plates (2)			
Style	Mounting Holes	Catalog Number	Weight lb (kg)
A	None (1)	2934D32G1	-
B	End	2934D14G1	0.34 (0.154)
C	Side	2934D33G1	0.42 (0.191)
D	End	2934D34G1	0.36 (0.163)

(1) No mounting holes in base plate. Side mounting holes in switch case must be used.  
 (2) Acceptable wire sizes 14 – 18 AWG (2.08 – 0.823 mm<sup>2</sup>); recommended terminal clamp torque 13 – 16 lb-in. (1.46 – 1.80 N•m).

Optional Conduit Threads		
Description	Catalog Number	Weight lb (kg)
Metric M20 - 20mm (per B.S. 4568)	M11	—

Example: 9007TUB4M11

Three Point Contacts — Ordering Information																		
Select Type number of desired contact operating sequence for standard contact switch. Change the letter following "T" or "FT" as shown below.																		
Change:	U to Y S to K	Contact Configuration Changes																
For example: TUB1 changes to TYB1 TSB1 changes to TKB1		From: <table style="display: inline-table; vertical-align: middle;"> <tr><td>A</td><td>B</td></tr> <tr><td>o</td><td>o</td></tr> <tr><td> </td><td> </td></tr> <tr><td>o</td><td>o</td></tr> </table> <table style="display: inline-table; vertical-align: middle;"> <tr><td>A</td><td>B</td></tr> <tr><td>o</td><td>o</td></tr> <tr><td> </td><td> </td></tr> <tr><td>o</td><td>o</td></tr> </table>	A	B	o	o			o	o	A	B	o	o			o	o
A	B																	
o	o																	
o	o																	
A	B																	
o	o																	
o	o																	

# Limit Switches

## 9007T and FT Severe Duty Mill and Foundry Switches

### Dimensions

#### Surface Mounting

Type T

Type FT

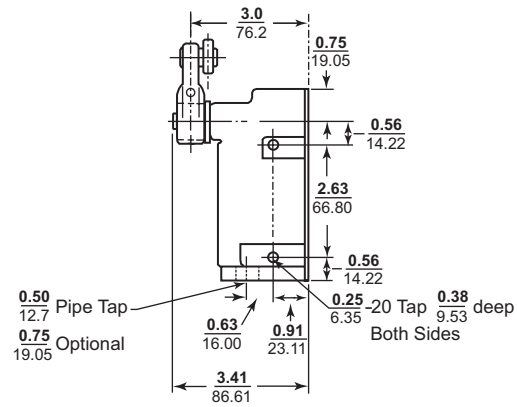
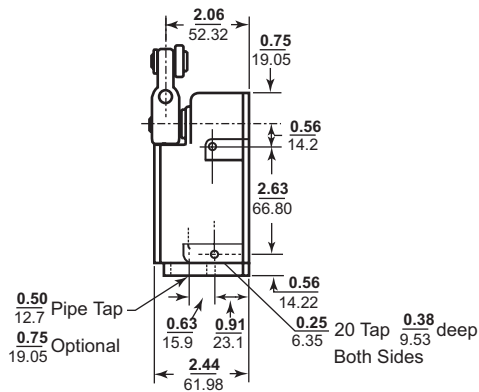

#### Base Plates

Style A

Style B

Style C

Style D

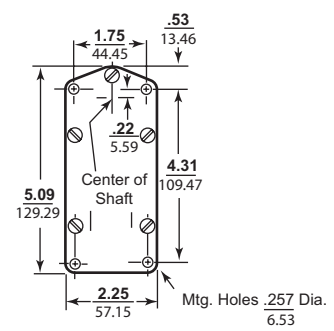
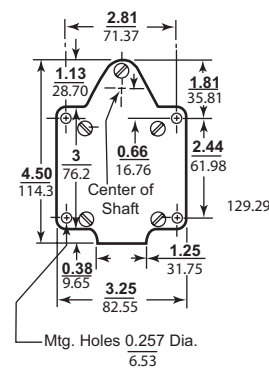
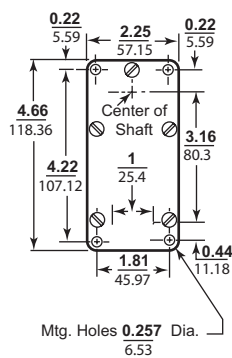
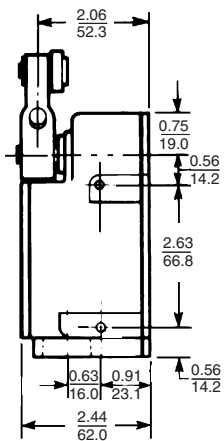

Dual dimensions:  $\frac{\text{in.}}{\text{mm}}$

# Limit Switches

## 9007T and FT Severe Duty Mill and Foundry Switches

### Dimensions

#### CAM Track Dimensions

##### Type T

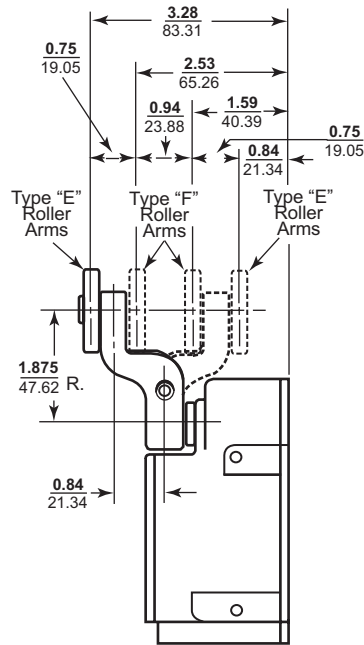
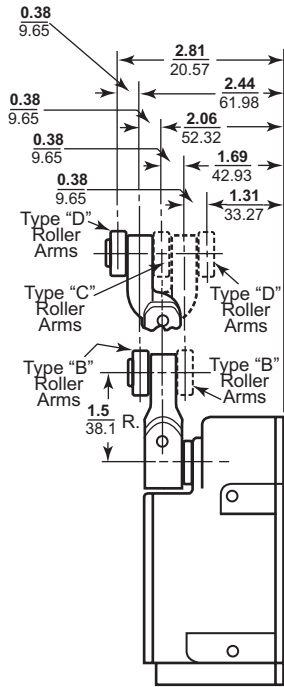

##### Type FT

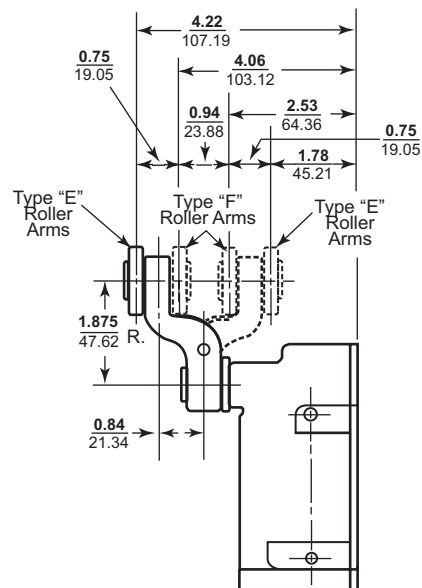
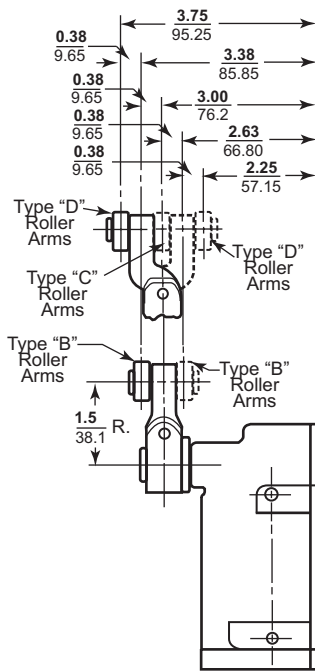

Dual dimensions:  $\frac{\text{in.}}{\text{mm}}$

Limit Switches

# Limit Switches

## 9007T and FT Severe Duty Mill and Foundry Switches

### Dimensions

#### Type T and FT Lever Arms

##### Standard Roller

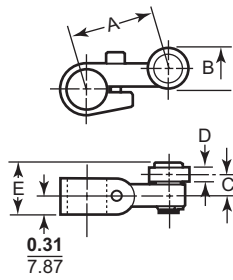

For dimension A refer to page 12.

##### Offset Type

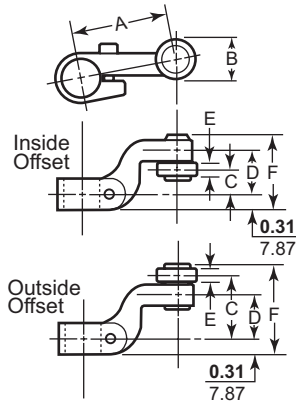

##### Adjustable Length Rod Type

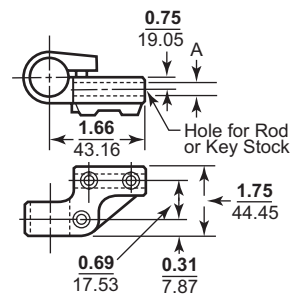

##### Ball Bearing Roller Type B16

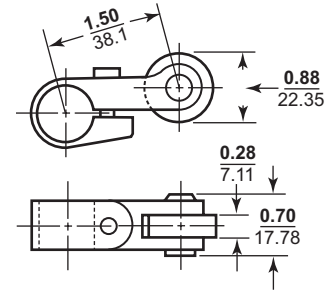

##### Roller Arm for use with Type R17

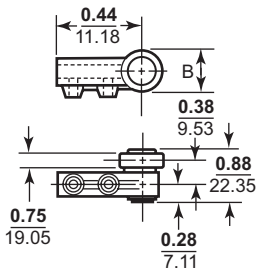

##### 1-Way Roller Type D4

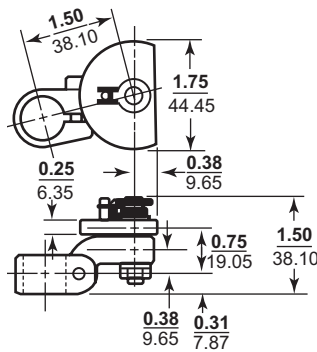

##### Weld-On Arm Type G10

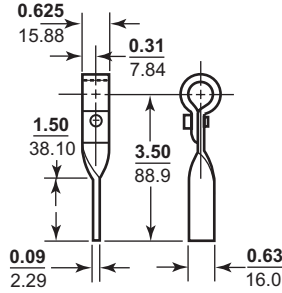

##### Cable Operated with Reset Type Y3

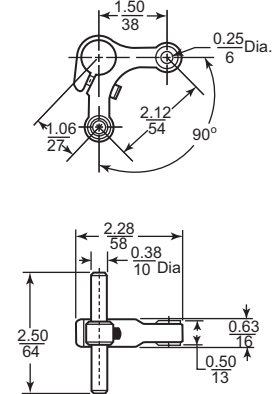

##### Cable Operated Type B27

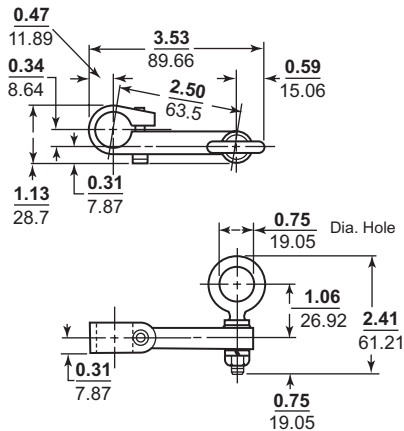

Dual dimensions:  $\frac{\text{in.}}{\text{mm}}$

NOTE: All levers on this page can be used on Type C limit switches by installing the 9007S9 hub.



# Limit Switches

## 9007T and FT Severe Duty Mill and Foundry Switches

### Dimensions

Type T and FT Lever Arms (continued)  
90° Forked

120° Forked

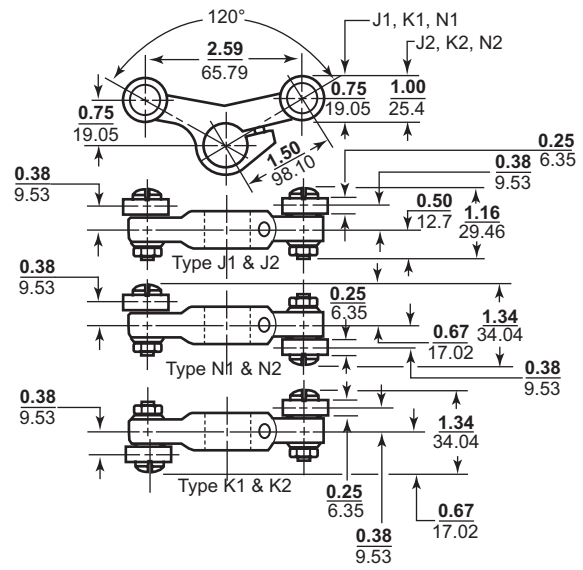
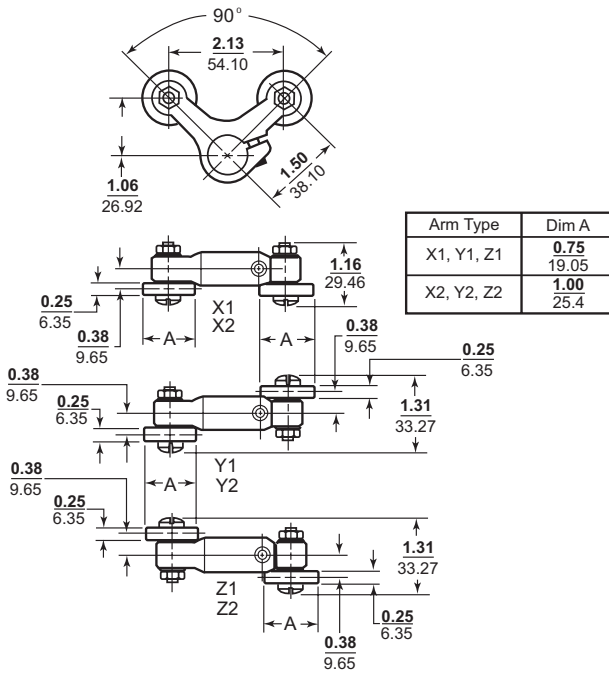

Limit Switches

## Limit Switches

### R.B. Denison® Lox-Switch™ L Severe Duty Mill and Foundry Switches

#### L100, L300 Mill and Foundry Switches, L140, L2153 Cable Pulls, L529 Belt Conveyor

Conforming to NEMA A600 and UL508

#### Description

##### L100W Switches ♦

Use the L100W Mill switches instead of other limit switches in the following applications:

- 1 Where the current load exceeds the typical heavy duty limit switch contact rating of 10 A and falls within the range of up to 20 A continuous.
- 2 Where an operating sequence is required that is not possible on other limit switches (35 choices with the L switches).
- 3 Where higher reset forces are required due to foreign material interfering with lever arm operation, or where long heavy arms must reset against gravity.

♦ L switches are not preceded by 9007. They are known as the R.B. Denison® Lox Switch™ L, and include conveyor belt and slack cable pull switches in the product offering.

##### L300W Switches

The L300W Foundry switches are for use in foundries or mills where the applications described above are required, and where falling foundry sand or similar material could build up and jam the operating mechanism. The shaft has a dust boot and extends from the switch case, preventing sand build up around the shaft. The devices can withstand hot falling sand up to 300° F (149° C).

#### Features L100, L300, L140, L2153, L525

- Captive cover screws
- Heavy duty snap action mechanism prevents teasing or false contact opening.
- Positive trip action prevents the lever from slipping around the 0.5 in. (12.7 mm) shaft even if not properly tightened.
- High current capability. 20 A maximum continuous
- Isolated (no polarity) double and triple circuits with double break (throw) action
- Wide 0.25 in. (6.3 mm) contact gap ensures very high shock and vibration resistance.
- Easy to access contacts allow for easy inspection and replacement.
- Stamped contact configuration number for easy identification even if the switch is painted
- Many contact arrangements to solve difficult applications
- Model L300 is an extra heavy duty version for very aggressive environments.
  - The booted shaft design prevents penetration of foreign materials such as sand, dust, or grit between the shaft and the bushing.
  - Heavy duty stainless steel springs and hardened spring operators permit longer life under extreme lever fly-back and high impact.
  - Same parameters as L100 models, except that the distance between the back of the switch and the lever is increased by 0.34 in. (8.6 mm).
- Two and three circuits in CW, CCW, neutral position, spring return and maintained, snap action or slow-make slow-break, two steps (L525) are available.
- 2 circuit models can be CW or CCW field converted.
- Wide range of options: high shock and vibration, with gold contact, low or very high temperature
- 0.5 in. (12.7 mm) NPT conduit entrance standard on 2-pole models (5 wires max.)
- 0.75 in. (19 mm) NPT conduit entrance standard on 3-pole models (7 wires max.)

#### L100, L300 Switches (fixed sequence)

##### L100 Mill

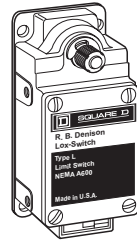

Page 224

##### L300 Foundry

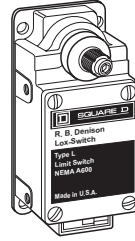

Page 226

- Model L300 is an extra heavy duty version for very aggressive environments
  - The booted shaft design prevents penetration of foreign materials such as sand, dust, or grit between the shaft and the bushing.
  - Heavy duty stainless steel springs and hardened spring operators permit longer life under extreme lever fly-back and high impact.
  - Same parameters as L100 models, except that the distance between the back of the switch and the lever is increased by 0.34 in. (8.6 mm).

#### Cable Pulls (fixed sequence)

##### L140 Mill and Foundry

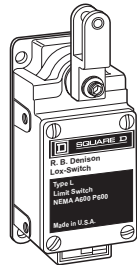

Page 228

##### L2153 Mill and Foundry

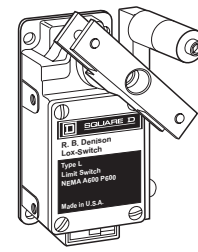

Page 228

#### Belt Conveyors

##### L525 Mill and Foundry

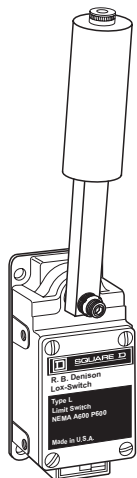

Page 229

Conveyor belt limit switches are ideal for policing the lateral movement of belt conveyors. When the conveyor belt shifts, it contacts the switch roller and a 12° movement of the lever transfers the first set of contacts. This set is usually wired to initiate a warning alarm system to alert the worker that the belt is moving off the rollers. Further lateral movement of the belt, causing the lever to move another 8°, trips the second set of contacts. These contacts are normally wired to the conveyor drive system and when actuated stop the system, minimizing damage to the conveyor or loss of material on the belt.

# Limit Switches

## R.B.Denison® Lox-Switch™ L Severe Duty Mill and Foundry Switches L100, L300 Mill and Foundry Switches, L140, L2153 Cable Pulls, L529 Belt Conveyor

### Environment characteristics

Conforming to standards	UL508
Product certifications	UL Listed, CSA Certified, CE Marked
Protective treatment	Corrosion resistant gray paint
Ambient air temperature	-10 to +185 °F (-23 to +85 °C) With H prefix: -10 to +350 °F (-23 to +177 °C). <sup>(1)</sup>
Vibration resistance	10G (10–55 Hz)
Shock resistance	30G
Electric shock protection	Class O
Degree of protection	NEMA Types 1, 2, 4, 12, 13, IP65, 66, 67
Cable entry or connector	0.5" NPT (metric available)
Materials	Cast zinc ◊

1. For a switch with an ambient temperature rating up to 350 °F (177 °C), add an H to the beginning of the catalog number.  
For example, change catalog number L100WS2M2 to HL100WS2M2.

### Contact block characteristics

Rated operational characteristics hard contacts	AC Voltage	NEMA A600 Ithe = 20 A 20 A Resistive and continuous
	DC Voltage	NEMA P600 Ithe = 20 A 20 A Resistive and continuous
Rated insulation voltage		600 V
Rated impulse withstand voltage		2,500 Vac for 1 minute for CE, 2,200 Vac for 1 minute for UL, and 2,640 Vac for 1 minute for CSA
Positive opening		No
Short circuit protection		20 A Bussmann Class CC KTK-R-20 fuse, non-time-delay
Terminal wire sizes (Cabling/Screw Clamp)		12 – 22 AWG (3.31 mm <sup>2</sup> – 0.326 mm <sup>2</sup> ) wire max.
Maximum actuation speed		15.2 mpm / 27.4 mpm (50 fpm / 90 fpm) with 45 ° Cam angle, levers only

### Maximum current ratings for control circuit contacts

Contacts	Volts	AC						DC					
		Inductive 35% Power Factor						Resistive 75% Power Factor		Inductive and Resistive			
		Make		Break		Con- tinuous Carrying Amperes	Make, Break and Continuous Carrying Amperes	Volts	Make and Break Amperes		Con- tinuous Carrying Amperes		
		Amperes	VA	Amperes	VA				Single Throw	Double Throw			
SPDT	120	150	18,000	20	2400	20	20		120	5.0		9	20
Quick	240	75	18,000	12.5	3000	20	20	250	1.0	9	20		
Make and Break	480	37.5	18,000	6.25	3000	20	20	600	0.2	9	20		
	600	30	18,000	5	3000	20	20						
All Slow	120	60	7200	6	720	20	10	20	...	...	...	...	
Make	240	30	7200	3	720	20	10	20	...	...	...	...	
and Break	480	15	7200	1.5	720	20	10	20	...	...	...	...	
	600	12	7200	1.2	720	20	10	20	...	...	...	...	

### Characteristics for material and ratings comparisons — standard switches ◊

	9007 Type T/FT	Type L (R. B. Denison Lox Switch)
Body material	Cast zinc	Cast aluminum
Cover material	Cast zinc	Aluminum
Base plate material	Steel with zinc plating	Steel with chromate plating
Shaft seal material	Nitrile	PVC
Contact block material	Phenolic	Glass filled nylon
Moveable contact material	Fine silver on copper backing	Coin Silver on steel backing
Stationary contact material	Fine silver on copper backing	90/10 AgCdO on copper backing
Low ambient temperature rating	-10° F	0° F
High ambient temperature at full rating ♦	180° F	200° F
Enclosure rating	NEMA Types 1, 2, 4, 12 and 13	NEMA Types 1, 4 and 13
Vibration resistance	10G (10–150 Hz)	40G max (10-150 Hz)

- ♦ Many switches are available with higher or lower temperature limits by selecting special versions or special options. See page 233.

# Limit Switches

## R.B.Denison® Lox-Switch™ L Severe Duty Mill and Foundry Switches

### L100 Mill Switches

L100 Mill Switches					
Description	Operating Torque	Contact Diagram	Catalog Number	Operating Data	Weight, lb (kg)
Snap-action CW spring return	190 oz-in (1.34 N•m)		L100WS2M1	A (see page 225)	1.51 (0.68)
Snap-action CCW spring return	190 oz-in (1.34 N•m)		L100WS2M2	A (see page 225)	1.51 (0.68)
Maintained contact ■ CW and CCW snap action	45 oz-in (0.32 N•m)		L100WS2M3	A (see page 225)	1.51 (0.68)
Snap action CW spring return	190 oz-in (1.34 N•m)		L100WDR2M4	A (see page 225)	1.51 (0.68)
Snap action CCW spring return	190 oz-in (1.34 N•m)		L100WDR2M5	A (see page 225)	1.51 (0.68)
Maintained contact ■ CW and CCW snap action	45 oz-in (0.32 N•m)		L100WDR2M6	A (see page 225)	1.51 (0.68)
Snap action CCW spring return	190 oz-in (1.34 N•m)		L100WDL2M7	A (see page 225)	1.51 (0.68)
Snap action CW spring return	190 oz-in (1.34 N•m)		L100WDL2M8	A (see page 225)	1.51 (0.68)
Snap action CW 1 N.C./ 2 N.O. spring return	190 oz-in (1.34 N•m)		L100WTR2M10	A (see page 225)	1.51 (0.68)
Snap action CCW 1 N.O./ 2 N.C. spring return	190 oz-in (1.34 N•m)		L100WTR2M11	A (see page 225)	1.51 (0.68)
Maintained contact ■ CW and CCW snap action, 3 poles	45 oz-in (0.32 N•m)		L100WTR2M12	A (see page 225)	1.51 (0.68)
Snap action CCW 2 N.O./ 1 N.C. spring return	190 oz-in (1.34 N•m)		L100WTL2M13	A (see page 225)	1.51 (0.68)
Snap action CW 1 N.O./ 2 N.C. spring return	190 oz-in (1.34 N•m)		L100WTL2M14	A (see page 225)	1.51 (0.68)
Maintained contact ■ CW and CCW snap action, 3 poles	45 oz-in (0.32 N•m)		L100WTL2M15	A (see page 225)	1.51 (0.68)
Neutral position ■ spring return, slow make and break 1 N.O. contact per direction	95 oz-in (0.67 N•m)		L100WN2M16	B (see page 225)	1.51 (0.68)
Neutral position ■ spring return, slow make and break 1 N.O. contact for both directions	95 oz-in (0.67 N•m)		L100WN2M17	B (see page 225)	1.51 (0.68)

Dimensions:  
page 234

Operating Data:  
page 225

Interpretation of Catalog Numbers:  
page 235

# Limit Switches

## R.B.Denison® Lox-Switch™ L Severe Duty Mill and Foundry Switches

### L100 Mill Switches

L100 Mill Switches (continued)					
Description	Operating Torque	Contact Diagram	Catalog Number	Operating Data	Weight, lb (kg)
Neutral position ■ spring return, slow make and break 1 N.C.-CW, 1 N.C.-CCW	95 oz-in (0.67 N•m)		L100WNC2M18	B (see table below)	1.51 (0.68)
Neutral position ■ spring return, slow make and break 2 N.O.-CW, 1 N.O.-CCW	95 oz-in (0.67 N•m)		L100WTRN2M20	B (see table below)	1.51 (0.68)
Neutral position ■ spring return, slow make and break N.O.-CW, 2 N.O.-CCW	95 oz-in (0.67 N•m)		L100WTLN2M21	B (see table below)	1.51 (0.68)
Slow make-before-break, CW spring return	170 oz-in (1.2 N•m)		L100WS02M22	C (see table below)	1.51 (0.68)
Slow make-before-break, CCW spring return	170 oz-in (1.2 N•m)		L100WS02M23	C (see table below)	1.51 (0.68)
Neutral position ■ N.O.-CW, N.O.-CCW spring return, snap action	170 oz-in (1.2 N•m)		L100WNS2M26	D (see table below)	1.51 (0.68)
Neutral position ■ N.O.-CW, N.O.-CCW maintained in CCW only	170 oz-in (1.2 N•m)		L100WNSR2M28	D (see table below)	1.51 (0.68)
Neutral position ■ N.O.-CW, N.O.-CCW maintained in CW only	170 oz-in (1.2 N•m)		L100WNSL2M29	D (see table below)	1.51 (0.68)
Neutral position ■ N.C.-CW, N.C.-CCW spring return, snap action	170 oz-in (1.2 N•m)		L100WNC2M34	D (see table below)	1.51 (0.68)
Neutral position ■ N.O.-CW, N.O./N.C.-CCW spring return, slow make and break	95 oz-in (0.67 N•m)		L100WTRN1C2M38	B (see table below)	1.51 (0.68)
Neutral position ■ N.O./N.C.-CW, N.O.-CCW spring return, slow make and break	95 oz-in (0.67 N•m)		L100WTLN1C2M39	B (see table below)	1.51 (0.68)
Neutral position ■ N.O./N.C.-CW, N.C.-CCW spring return, slow make and break	95 oz-in (0.67 N•m)		L100WTRN2C2M40	B (see table below)	1.51 (0.68)
Neutral position ■ N.C.-CW, N.O./N.C.-CCW spring return, slow make and break	95 oz-in (0.67 N•m)		L100WTLN2M41	B (see table below)	1.51 (0.68)
Neutral position ■ N.O./N.C.-CW, N.C.-CCW spring return, snap action	95 oz-in (0.67 N•m)		L100WTRN2CS2M48	D (see table below)	1.51 (0.68)

Operating Data for Contact Arrangements				
	A	B	C	D
Pretravel	17° nominal	7° maximum	7° nominal	9° nominal
Differential travel	11° nominal	4° maximum	-	6° nominal
Overlapping travel	-	-	4° nominal	-
Total travel	80°	70°	80°	70°
Recommended installation travel	20°-35°	10° - 25°	20° - 35°	13° - 30°
Repetitive accuracy of switch	± 0.03x	-	-	± 0.03x
Operating torque, max with return spring	190 oz-in (1.34 N•m)	95 oz-in (0.67 N•m)	170 oz-in (1.2 N•m)	170 oz-in (1.2 N•m)
Maintained contact	45 oz-in (0.317 N•m)	-	-	45 oz-in (0.317 N•m)

Dimensions:  
page 234

Operating Sequences for Conveyor Belts:  
page 229

# Limit Switches

## R.B.Denison® Lox-Switch™ L Severe Duty Mill and Foundry Switches

### L300 Foundry Switches

L300 Foundry Switches					
Description	Operating Torque	Contact Diagram	Catalog Number	Operating Data	Weight, lb (kg)
Snap-action CW spring return	190 oz-in (1.34 N•m)		L300WS2M1	A (see page 227)	1.54 (0.70)
Snap-action CCW spring return	190 oz-in (1.34 N•m)		L300WS2M2	A (see page 227)	1.54 (0.70)
Maintained contact ■ CW and CCW snap action	45 oz-in (0.32 N•m)		L300WS2M3	A (see page 227)	1.54 (0.70)
Snap action CW spring return	190 oz-in (1.34 N•m)		L300WDR2M4	A (see page 227)	1.54 (0.70)
Snap action CCW spring action	190 oz-in (1.34 N•m)		L300WDR2M5	A (see page 227)	1.54 (0.70)
Maintained contact ■ CW and CCW snap action	45 oz-in (0.32 N•m)		L300WDR2M6	A (see page 227)	1.54 (0.70)
Snap action CCW spring return	190 oz-in (1.34 N•m)		L300WDL2M7	A (see page 227)	1.54 (0.70)
Snap action CW spring return	190 oz-in (1.34 N•m)		L300WDL2M8	A (see page 227)	1.54 (0.70)
Snap action CW 1 N.C./2 N.O. spring return	190 oz-in (1.34 N•m)		L300WTR2M10	A (see page 227)	1.54 (0.70)
Snap action CCW 1 N.O./2 N.C. spring return	190 oz-in (1.34 N•m)		L300WTR2M11	A (see page 227)	1.54 (0.70)
Maintained contact ■ CW and CCW snap action, 3 poles	45 oz-in (0.32 N•m)		L300WTR2M12	A (see page 227)	1.54 (0.70)
Snap action CCW 2 N.O./1 N.C. spring return	190 oz-in (1.34 N•m)		L300WTL2M13	A (see page 227)	1.54 (0.70)
Snap action CW 1 N.O./2 N.C. spring return	190 oz-in (1.34 N•m)		L300WTL2M14	A (see page 227)	1.54 (0.70)
Maintained contact ■ CW and CCW snap action, 3 poles	45 oz-in (0.32 N•m)		L300WTL2M15	A (see page 227)	1.54 (0.70)
Neutral position ■ spring return, slow make and break 1 N.O. contact per direction	95 oz-in (0.67 N•m)		L300WN2M16	B (see page 227)	1.54 (0.70)
Neutral position ■ spring return, slow make and break 1 N.O. contact for both directions	95 oz-in (0.67 N•m)		L300WN2M17	B (see page 227)	1.54 (0.70)

Dimensions:  
page 234

Operating Data:  
page 227

Interpretation of Catalog Numbers:  
page 235

# Limit Switches

## R.B.Denison® Lox-Switch™ L Severe Duty Mill and Foundry Switches

### L300 Foundry Switches

#### L300 Foundry Switches (continued)

Description	Operating Torque	Contact Diagram	Catalog Number	Operating Data	Weight, lb (kg)
Neutral position ■ spring return, slow make and break 1 N.C.-CW, 1 N.C.-CCW	95 oz-in (0.67 N•m)		L300WNC2M18	B (see table below)	1.54 (0.70)
Neutral position ■ spring return, slow make and break 2 N.O.-CW, 1 N.O.-CCW	95 oz-in (0.67 N•m)		L300WTRN2M20	B (see table below)	1.54 (0.70)
Neutral position ■ spring return, slow make and break N.O.-CW, 2 N.O.-CCW	95 oz-in (0.67 N•m)		L300WTLN2M21	B (see table below)	1.54 (0.70)
Slow make-before-break, CW spring return	170 oz-in (1.2 N•m)		L300WS02M22	C (see table below)	1.54 (0.70)
Slow make-before-break, CCW spring return	170 oz-in (1.2 N•m)		L300WS02M23	C (see table below)	1.54 (0.70)
Neutral position ■ N.O.-CW, N.O.-CCW spring return, snap action	170 oz-in (1.2 N•m)		L300WNS2M26	D (see table below)	1.54 (0.70)
Neutral position ■ N.O.-CW, N.O.-CCW maintained in CCW only	170 oz-in (1.2 N•m)		L300WNSR2M28	D (see table below)	1.54 (0.70)
Neutral position ■ N.O.-CW, N.O.-CCW maintained in CW only	170 oz-in (1.2 N•m)		L300WNSL2M29	D (see table below)	1.54 (0.70)
Neutral position ■ N.C.-CW, N.C.-CCW spring return, snap action	170 oz-in (1.2 N•m)		L300WNCS2M34	D (see table below)	1.54 (0.70)
Neutral position ■ N.O.-CW, N.O./N.C.-CCW spring return, slow make and break	95 oz-in (0.67 N•m)		L300WTRN1C2M38	B (see table below)	1.54 (0.70)
Neutral position ■ N.O./N.C.-CW, N.O.-CCW Spring return, slow make and break	95 oz-in (0.67 N•m)		L300WTLN1C2M39	B (see table below)	1.54 (0.70)
Neutral position ■ N.O./N.C.-CW, N.C.-CCW spring return, slow make and break	95 oz-in (0.67 N•m)		L300WTRN2C2M40	B (see table below)	1.54 (0.70)
Neutral position ■ N.C.-CW, N.O./N.C.-CCW spring return, slow make and break	95 oz-in (0.67 N•m)		L300WTLN2M41	B (see table below)	1.54 (0.70)
Neutral position ■ N.O./N.C.-CW, N.C.-CCW spring return, snap action	95 oz-in (0.67 N•m)		L300WTRN2CS2M48	D (see table below)	1.54 (0.70)

#### Operating Data for Contact Arrangements

	A	B	C	D
Pretravel	17° nominal	7° maximum	7° nominal	9° nominal
Differential travel	11° nominal	4° maximum	-	6° nominal
Overlapping travel	-	-	4° nominal	-
Total travel	80°	70°	80°	70°
Recommended installation travel	20°-35°	10° - 25°	20° - 35°	13° - 30°
Repetitive accuracy of switch	± 0.03x	-	-	± 0.03x
Operating torque, max with return spring	190 oz-in (1.34 N•m)	95 oz-in (0.67 N•m)	170 oz-in (1.2 N•m)	170 oz-in (1.2 N•m)
Maintained contact	45 oz-in (0.317 N•m)	-	-	45 oz-in (0.317 N•m)

Dimensions:  
page 234

Operating Sequences for Conveyor Belts:  
page 229

## Limit Switches

### R.B.Denison® Lox-Switch™ L Severe Duty Mill and Foundry Switches L140 and L2153 Cable Pulls



L140 Cable Pull



L2153 Dual Pull Stop

#### L140 Series Cable Pulls (1)

Circuit	Direction	Catalog Number (2)	Weight lb (kg)
1 N.C.	CW right	<b>L142</b>	1.54 (0.70)
1 N.O. and 1 N.C.	CW right	<b>L143</b>	1.54 (0.70)
1 N.O. and 1 N.C.	CCW left	<b>L144</b>	1.54 (0.70)
1 N.C.	CCW left	<b>L145</b>	1.54 (0.70)
2 N.O. and 1 N.C.	CW right	<b>L146</b>	1.54 (0.70)
2 N.C. and 1 N.O.	CW right	<b>L147</b>	1.54 (0.70)
2 N.O. and 1 N.C.	CCW left	<b>L148</b>	1.54 (0.70)
2 N.C. and 1 N.O.	CCW left	<b>L149</b>	1.54 (0.70)

1. Style K levers were designed specifically for this application; see page 231 (order separately).
2. To complete the catalog number, refer to page 235 and add the suffix for the mounting plate style and the front cover material.

#### L2153 Dual Pull Stop

Description	Catalog Number	Weight lb (kg)
Dual pull cord switch—maintained contacts (stop and lever included)	<b>L2153</b>	2.04 (0.93)

#### Characteristics

Pretravel	17° ± 2°
Differential travel	11° ± 2°
Overlapping travel	—
Total travel	80°
Recommended installation travel	—
Repetitive accuracy of switch	± 0.03°
Operating torque, max with return spring	13–27 lb-in (1.47–3.05 N•m)
Reset torque	7–19 lb-in (0.79 –2.14 N•m)
Temperature range	-20 to 120 °F (-6.6 to 48.8 °C)
Maintained contact	—



# Limit Switches

## R.B.Denison® Lox-Switch™ L Severe Duty Mill and Foundry Switches L525 Belt Conveyor Switches

L525 Belt Conveyor Switches				
Description	Operating Torque	Contact Diagram	Catalog Number	Weight lb (kg)
2 step sequence CW spring return, snap action, 2 N.O.	150 oz-in (1.06 N•m)		L525WDR2M56	1.5 (0.68)
2 step sequence CCW spring return, snap action, 2 N.O.	150 oz-in (1.06 N•m)		L525WDL2M57	1.5 (0.68)
2 step sequence CW spring return, snap action, 2 N.C.	150 oz-in (1.06 N•m)		L525WDL2M58	1.5 (0.68)
2 Step sequence CCW spring return, snap action, 2 N.C	150 oz-in (1.06 N•m)		L525WDR2M59	1.5 (0.68)
2 Step sequence CW spring return, snap action, N.O./N.C ■	150 oz-in (1.06 N•m)		L100WS0S2M60	1.5 (0.68)

■ Two step snap action. One normally closed, one normally open; CW operation to first step to 2-C. Further CW operation to second step, 1-O, 1-C. Spring return. Pretravel 9° nominal. Additional travel 8° nominal. Differential second step 7° nominal. Differential first step 7° nominal.

### Characteristics

Pretravel	12° nominal
Additional travel	8° nominal
Differential travel	7° nominal
Total travel	75° nominal
Operating torque, max with return spring	150 oz-in nominal (1.06 N•m)

Limit Switches

# Limit Switches

## R.B.Denison® Lox-Switch™ L Severe Duty Mill and Foundry Switches L100/L300 Lever Arms

### Lever Arms

Lever arms are constructed of machined aluminum.

Dual dimensions: in. (mm)

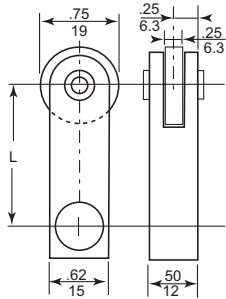

Style A

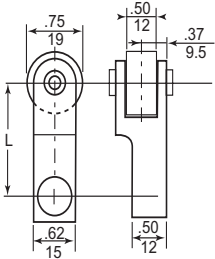

Style B

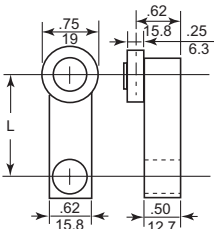

Style C

#### Style A Steel Roller

Arm	Steel roller		Catalog Number ♦	Weight lb (kg)
Length	Diameter	Width		
1.25 (31.7)	0.75 (19)	0.25 (6.3)	AC	0.06 (0.027)
1.50 (38.1)	0.75 (19)	0.25 (6.3)	AA	0.06 (0.027)
1.75 (44.4)	0.75 (19)	0.25 (6.3)	AD	0.07 (0.031)
2.00 (50.8)	0.75 (19)	0.25 (6.3)	AH	0.08 (0.036)
2.25 (57.1)	0.75 (19)	0.25 (6.3)	AJ	0.09 (0.041)
2.50 (63.5)	0.75 (19)	0.25 (6.3)	AO	0.10 (0.045)
2.75 (69.8)	0.75 (19)	0.25 (6.3)	AK	0.10 (0.045)
3.00 (76.2)	0.75 (19)	0.25 (6.3)	AB	0.11 (0.050)
3.50 (88.9)	0.75 (19)	0.25 (6.3)	AL	0.12 (0.054)
4.00 (101.6)	0.75 (19)	0.25 (6.3)	AM	0.13 (0.059)
4.50 (114.3)	0.75 (19)	0.25 (6.3)	AN	0.14 (0.064)
5.00 (127.0)	0.75 (19)	0.25 (6.3)	AP	0.16 (0.073)
5.50 (139.7)	0.75 (19)	0.25 (6.3)	AQ	0.18 (0.082)
6.00 (152.4)	0.75 (19)	0.25 (6.3)	AR	0.20 (0.091)

#### Style A Options

Diameter	Description	Catalog Number—Add Suffix
1.00 (25.4)	Roller	1
1.25 (32)	Roller	4
1.50 (38.1)	Roller	2
—	Nylon roller	N
0.75 (19)	Ball bearing roller	R
—	Stainless steel roller	NS

#### Style B Steel Roller

Arm	Steel roller		Catalog Number	Weight lb (kg)
Length	Diameter	Width		
1.50 (38.1)	0.75 (19)	0.50 (12.7)	BA	0.06 (0.027)
2.00 (50.8)	0.75 (19)	0.50 (12.7)	BH	0.08 (0.036)
2.50 (63.5)	0.75 (19)	0.50 (12.7)	BO	0.10 (0.045)
3.00 (76.2)	0.75 (19)	0.50 (12.7)	BB	0.12 (0.054)
4.00 (101.6)	0.75 (19)	0.50 (12.7)	BM	0.13 (0.059)
4.50 (114.3)	0.75 (19)	0.50 (12.7)	BN	0.14 (0.064)
5.50 (139.7)	0.75 (19)	0.50 (12.7)	BQ	0.18 (0.082)
6.00 (152.4)	0.75 (19)	0.50 (12.7)	BR	0.20 (0.091)

#### Style B Options

Diameter	Description	Catalog Number Add Suffix
—	Nylon roller	N
1.50 (38.1)	Roller	2

#### Style C Steel Roller On Side

Arm	Steel roller		Catalog Number	Weight lb (kg)
Length	Diameter	Width		
1.25 (31.7)	0.75 (19)	0.25 (6.3)	CC	0.06 (0.027)
1.50 (38.1)	0.75 (19)	0.25 (6.3)	CA	0.06 (0.027)
1.75 (44.4)	0.75 (19)	0.25 (6.3)	CD	0.07 (0.031)
2.00 (50.8)	0.75 (19)	0.25 (6.3)	CH	0.08 (0.036)
2.50 (63.5)	0.75 (19)	0.25 (6.3)	CO	0.10 (0.045)
3.00 (76.2)	0.75 (19)	0.25 (6.3)	CB	0.11 (0.050)
3.50 (88.9)	0.75 (19)	0.25 (6.3)	CL	0.12 (0.054)
4.00 (101.6)	0.75 (19)	0.25 (6.3)	CM	0.13 (0.059)
6.00 (152.4)	0.75 (19)	0.25 (6.3)	CR	0.20 (0.091)

#### Style C Options

Diameter	Description	Catalog Number—Add Suffix
1.0 (24.5)	Roller	1
1.25 (32)	Roller	4
1.50 (38.1)	Roller	2
—	Nylon roller	N

Dimensions:  
page 234

# Limit Switches

## R.B.Denison® Lox-Switch™ L Severe Duty Mill and Foundry Switches L100/L300 Lever Arms

Dual dimensions: in. (mm)

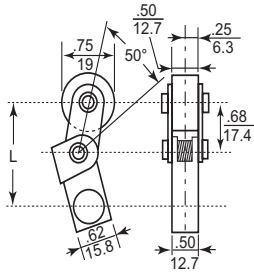

Style E

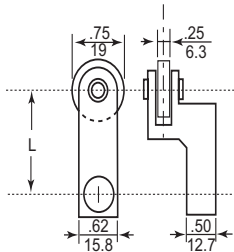

Style K

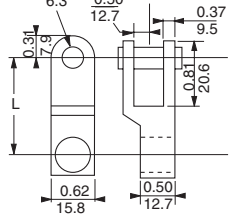

Style K

### Style E One Way Steel Roller

Arm	Steel roller		Catalog Number	Weight lb (kg)
Length	Diameter	Width		
1.50 (38.1)	0.75 (19)	0.50 (12.7)	EA	0.30 (0.136)
1.75 (44.4)	0.75 (19)	0.50 (12.7)	ED	0.40 (0.181)
3.00 (76.2)	0.75 (19)	0.50 (12.7)	EB	0.50 (0.227)

### Style E Options

Diameter in. (mm)	Description	Catalog Number Add Suffix
—	Nylon roller	N

### Style F Offset Steel Roller

Arm	Steel roller	Roller Position		Catalog Number	Weight lb (kg)
Length	Diameter	Offset	Width		
1.50 (38.1)	0.75 (19)	0.62 (15.8)	0.15 (3.8)	FB	0.06 (0.027)
1.50 (38.1)	0.75 (19)	0.87 (22.2)	0.15 (3.8)	FA	0.06 (0.027)
1.50 (38.1)	0.75 (19)	1.00 (25.4)	0.15 (3.8)	FC	0.06 (0.027)
2.00 (50.8)	0.75 (19)	1.00 (25.4)	0.15 (3.8)	FE	0.08 (0.036)
2.50 (63.5)	0.75 (19)	1.00 (25.4)	0.15 (3.8)	FG	0.10 (0.045)
3.00 (76.2)	0.75 (19)	0.62 (15.8)	0.15 (3.8)	FI	0.11 (0.050)
3.00 (76.2)	0.75 (19)	1.00 (25.4)	0.15 (3.8)	FJ	0.11 (0.050)

♦ Example: AC — This is the complete catalog number to order.

### Style F Options

Diameter	Description	Catalog Number—Add Suffix
1.00 (24.5)	Roller	1
—	Nylon roller	N

### Style K (for use with L140 cable pulls)

Arm	Steel roller	Description	Catalog Number ♦	Weight lb (kg)
Length	Diameter			
1.50 (38.1)	—	—	KA	0.05 (0.023)
2.50 (63.5)	—	—	KO	0.08 (0.036)
3.00 (76.2)	—	—	KB	0.09 (0.041)

### Style L (renewal parts for L2153 dual pull stop)

Description	Catalog Number	Weight lb (kg)
Lever	AL1746	0.25 (0.113)
Mechanical stop	AL1649	0.10 (0.045)

# Limit Switches

## R.B.Denison® Lox-Switch™ L Severe Duty Mill and Foundry Switches Lever Arms

Dual dimensions: in. (mm)

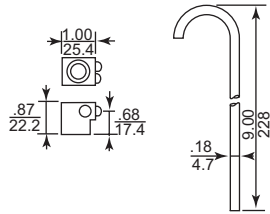

Style R

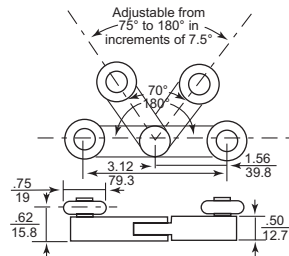

Style V

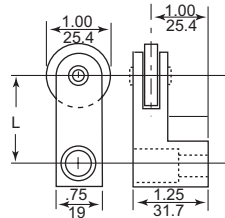

Style LA

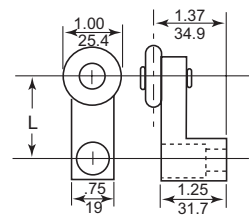

Style LC

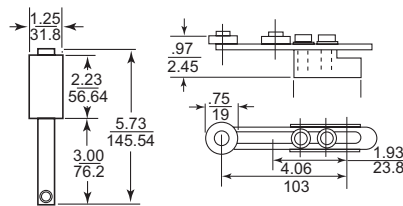

Rolling Pin

Adjustable Rolling Pin

Style R Steel Rod		
Description	Catalog Number	Weight lb (kg)
Hub only	R	0.10 (0.045)
Rod only	R9	0.09 (0.041)

Style V Yoke (for maintained position switches)					
Arm	Steel roller	Description	Width	Catalog Number	Weight lb (kg)
Length	Diameter			VA	0.50 (0.227)

Style V Options					
Diameter	Description			Catalog Number—Add Suffix	
1.0 (24.5)	Roller			1	
	Nylon roller			N	
0.75 (19)	Ball bearing roller			R	

Style LA (to pass over switch cover)					
Arm	Steel roller	Description	Width	Catalog Number	Weight lb (kg)
Length	Diameter				
1.50 (30)				LAA1	0.12 (0.054)
2.00 (50)				LAH1	0.12 (0.054)
2.50 (63)				LA01	0.12 (0.054)

Style LA Options		
Diameter	Description	Catalog Number—Add Suffix
1.5 (38)	Roller	2
—	Nylon roller	N

Style LC (to pass over switch cover)					
Arm	Steel roller	Description	Width	Catalog Number	Weight lb (kg)
Length	Diameter				
1.50 (30)				LCA1	0.12 (0.054)
2.00 (50)				LCH1	0.12 (0.054)
2.50 (63)				LCO1	0.13 (0.059)

Style LC Options					
Diameter	Description			Catalog Number—Add Suffix	
1.25 (32)	Roller			4	
1.5 (38)	Roller			2	
—	Nylon roller			N	

Rolling Pin (for use with 2 step switches for conveyor or belt applications)					
Arm	Steel roller	Description	Width	Catalog Number	Weight lb (kg)
Length	Diameter				
2.25 (75.1)				AL1650	0.30 (0.136)
2.25 (75.1)		High temp. Teflon® material		AL16501	0.33 (0.150)
3.0 (50.8)				AL1802	0.33 (0.150)

Rolling Pin (adjustable)					
Arm	Steel roller	Description	Width	Catalog Number	Weight lb (kg)
Length	Diameter				
2.00 (51) to 4.00 (102)	0.75 (19)		0.25 (6.3)	AL1650	0.30 (0.136)

♦ Example: KA — This is the complete catalog number to order.

Note: No hub component is needed for Type AL rolling pins. The arm mounts directly onto the shaft of the switch.

Dimensions:  
page 234

# Limit Switches

## R.B.Denison® Lox-Switch™ L Severe Duty Mill and Foundry Switches

### L100/L300 Options and Accessories



Mini Change Connector



Straight Male Connector



90° Angle Male Connector

Housing Options •			
Description	Example Full Catalog Number	Catalog Number Add Prefix	Weight lb (kg)
0.75" conduit opening Available on 2 circuit switches. Standard on 3 circuit switches	L100WS2M1 changes to GL100WS2M1	G	1.54 (0.70)
High temperature 0 to +350 °F (-17.7 to +176.6 °C) ■ Metal front cover only	L100WS2M1 changes to HL100WS2M1	H	1.54 (0.70)
Low temperature -20 to 200 °F (-28.8 to +93.3 °C) ■	L100WS2M1 changes to TL100WS2M1	T	1.54 (0.70)
High shock Available only on operating sequences 1, 2, 4, 5, 7-11, 13, 14	L100WS2M1 changes to L526WS2M1 L300WS2M1 changes to L326WS2M1	526/326	1.54 (0.70)
Gold contacts	L100WS2M1 changes to L522WS2M1 L300WS2M1 changes to L322WS2M1	522/322	1.54 (0.70)
Metric conduit threads M20 (20 mm)	L100WS2M1 changes to ML100WS2M1	M	1.54 (0.70)
Wiring			
Description	Example Full Catalog Number	Catalog Number Add Prefix	Weight lb (kg)
Straight male receptacle 4-pin ▲ Factory prewired	L100WS2M1 changes to PL100WS2M1	P	1.54 (0.70)
90° Angle male receptacle 4-pin ▲ Factory prewired—facing right	L100WS2M1 changes to APL100WS2M1	AP	1.54 (0.70)
Ministyle male receptacle † 8 A max. 5-pin (double circuit) 7 A max. 7-pin (triple circuit)	L100WS2M1 changes to BL100WS2M1	B B	1.54 (0.70)
		Add Suffix	lb (kg)
Potted and prewired	L100WS2M1 changes to L100WS2M1P	P	1.54 (0.70)
5 wires 6 feet (1.8 mm) long	L100WS2M1 changes to L100WS2M1P12	P12	
5 wires 12 feet (3.6 mm) long	L100WS2M1 changes to L100WS2M1P18	P18	
5 wires 18 feet (5.5 mm) long	L100WS2M1 changes to L100WS2M1P18		
Front Covers			
Description	Example Full Catalog Number	Catalog Number Add Suffix	Weight lb (kg)
Standard metal		M	—
Transparent plastic cover with metal frame		PF	—
Transparent plastic cover with metal frame and Neon indicator light (not connected)		GF	—
	L100WS2M1 changes to L100WS2PF 1		1.54 (0.70)
Accessories			
Description		Catalog Number	Weight lb (kg)
<b>Sealed female plug and cable for P and AP connector</b>			
4 pin, #16 AWG STO cable 140 °F (60 °C)	4 ft. (1.21 m)	1010004	1.20 (0.54)
	6 ft. (1.82 m)	1010006	1.25 (0.57)
	10 ft. (3.04 m)	10100010	1.50 (0.68)
<b>Sealed female plug and cable for ministyle connector (B)</b>			
5 pin, #16 AWG STO cable 221 °F (105 °C)	3 ft. (0.91 m)	BH2053	1.50 (0.68)
	6 ft. (1.82 m)	BH2056	1.70 (0.77)
	12 ft. (3.65 m)	BH20512	2.10 (0.95)

- Other options available — contact your local field office for details.
- ▲ Receptacle is a 4-pin male APL/PL-SWTS, Cannon part # MS3102E20-4P-F79 or equal.
- † Ministyle male connector are:  
5-pin: Brad Harrison #41310 (or equal)  
7-pin: Brad Harrison #42805 (or equal)
- The minimum temperatures listed are based on the absence of freezing moisture or water.

# Limit Switches

## R.B.Denison® Lox-Switch™ L Severe Duty Mill and Foundry Switches

### Dimensions

#### Switches

Type L100

Type L300

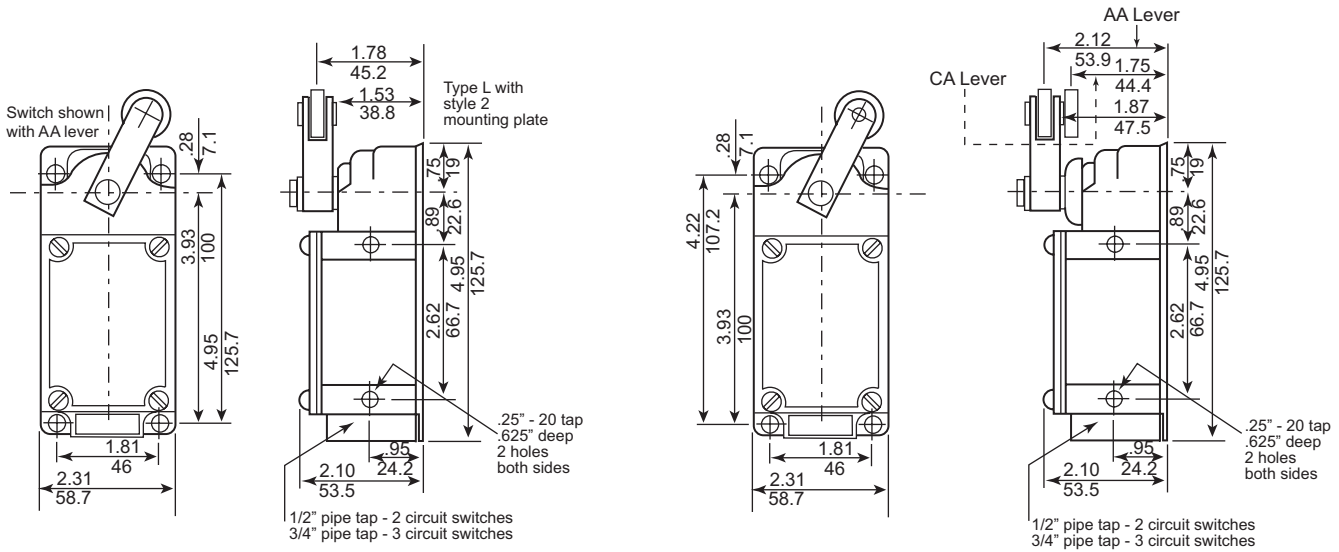

#### Base Plates

Style 1

Style 2

Style 3

Style 4

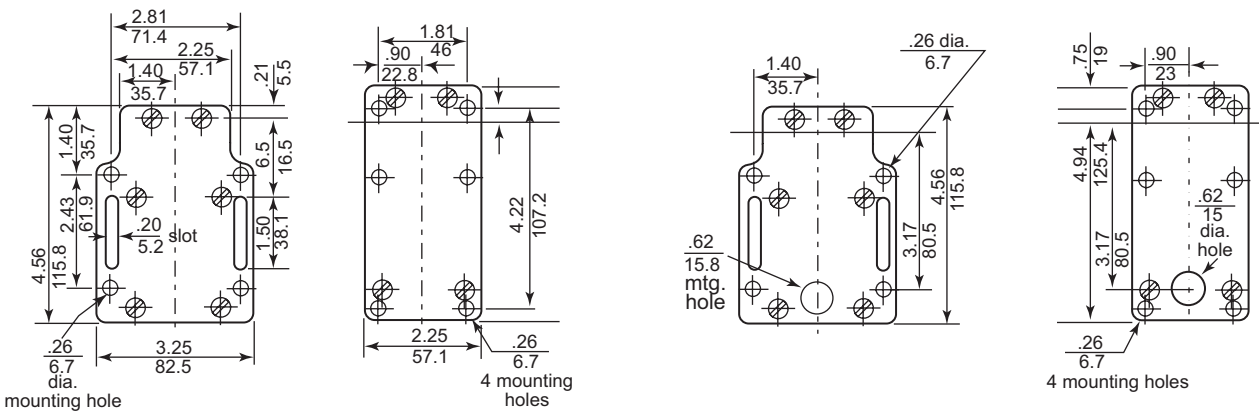

#### Receptacles

PL

APL

101000

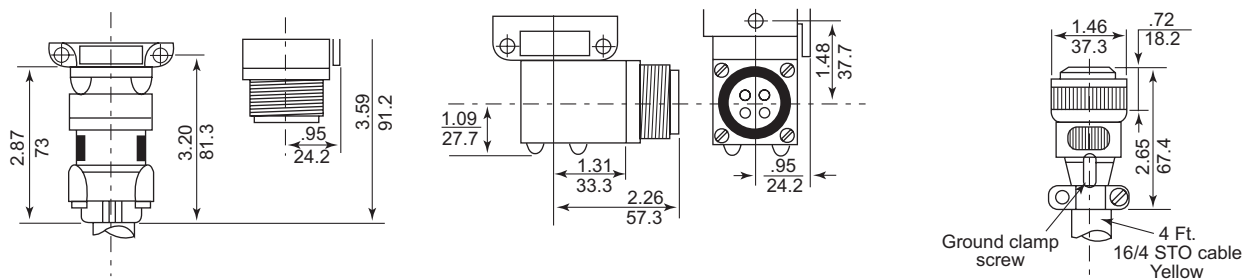

Dual dimensions:  $\frac{\text{in.}}{\text{mm}}$

# Limit Switches

## Severe Duty Mill and Foundry Switches

### Interpretation of Catalog Numbers

#### Interpretation of Catalog Numbers

The interpretation of catalog numbers is intended to help you understand how the catalog number is laid out. It is to be used with existing numbers only. The table below should not be used to generate new catalog numbers. If the contact sequence required is not listed, contact your local field office.

#### L100 and L300



Style	Housing			Function		Mounting Plate	Front Cover		Contact Arrangement	
L	1	0	0	W	S	2	P	F	1 to 60	
Mill	100	L14* and L2153 pull cord switches			WS	Style 1	1	M	Standard metal	
Foundry	300					Style 2	2	PF	Transparent plastic	
Belt Conveyor	525					Style 3	3	GF	Transparent plastic with neon light	
Two circuit single operation				Style 4		4				
Two circuit dual operation				WD						
Triple circuit				WT						
Neutral				WN						

The only modifications to the existing catalog numbers are:

b Base Plates:

- Select style 1, 2, 3 or 4

b Front Covers: Select metal, transparent plastic, or transparent plastic with neon light.

For special features see page 233.

#### 9007T and FT

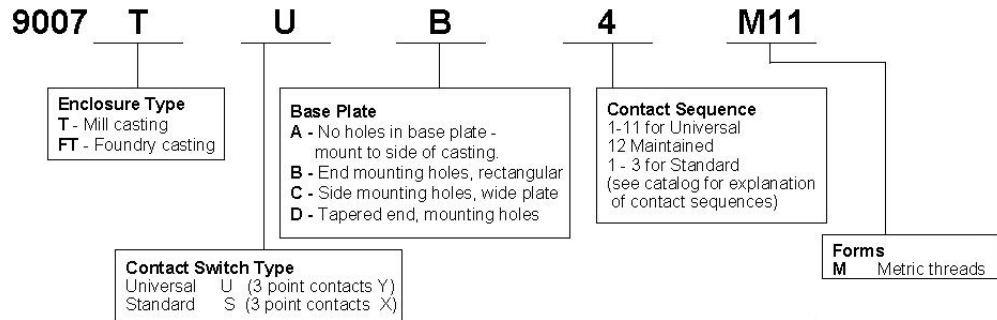







**Schneider Electric USA**

8001 Knightdale Blvd.  
Knightdale, NC 27545  
1-888-Square D  
1-888-778-2733  
[www.us.SquareD.com](http://www.us.SquareD.com)

9007CT0501 © 1997–2006 Schneider Electric All Rights Reserved